



DP0815S

ENG PART:DP-25.4x31.7ID-925T960-CW

925MHz to 960MHz Single Junction Drop-in Isolator

REV.	DESCRIPTION	REVISOR	DATE	APPROVED
A	Creating datasheet	ZC.Wu	2022/1/8	Nick

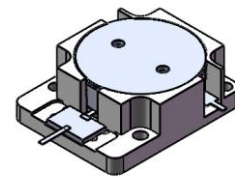

Applications:

- Wireless Infrastructure
- Power Amplifier

Features:

- Operating frequency range: 925MHz to960MHz
- Operating temperature range: -40°C to +100°C
- Storage temperature range: -50°C to +120°C
- Small surface-mount package delivered on T&R
- BeOfree&RoHS compliant

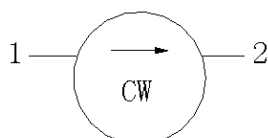

Block Diagram



Electrical Specifications:

ITEM	SPECIFICATION	
Frequency	925~960	MHz
Direction	CW	
Impedance	Typ: 50	Ω
Insertion Loss (Max.)	0.20@25°C \pm 5°C 0.25@-30~+85°C 0.30@-40°C~+100°C	dB
Isolation (Min.)	25@25°C \pm 5°C 23@-30~+85°C 21@-40°C~+100°C	dB
Return Loss (Min.)	25@25°C \pm 5°C 23@-30~+85°C 21@-40°C~+100°C	dB
3rd IMD (Max.)	-75@2x40W , CW tones, Spacing 5MHz	dBc
Group delay	-	ns
2nd harmonic	-	dBc
3rd harmonic	-	dBc
Power FWD/REV/PEAK	150/100/600	W
Termination/Attenuator	150/30	W/dB
Input Impedance ,real	-	Ω
Input Impedance ,imaginary	-	Ω
Output Impedance ,real	-	Ω
Output Impedance ,imaginary	-	Ω

Notes:

1. Exposure to maximum rating conditions for extended periods may reduce device reliability. There is no damage to device with only one parameter set at the limit and all other parameters set at or below their nominal value. Exceeding any of the limits listed here may result in permanent damage to the device.
2. Performance is guaranteed under the conditions listed in this table and over the operating temperature range.



Mechanical Specifications:

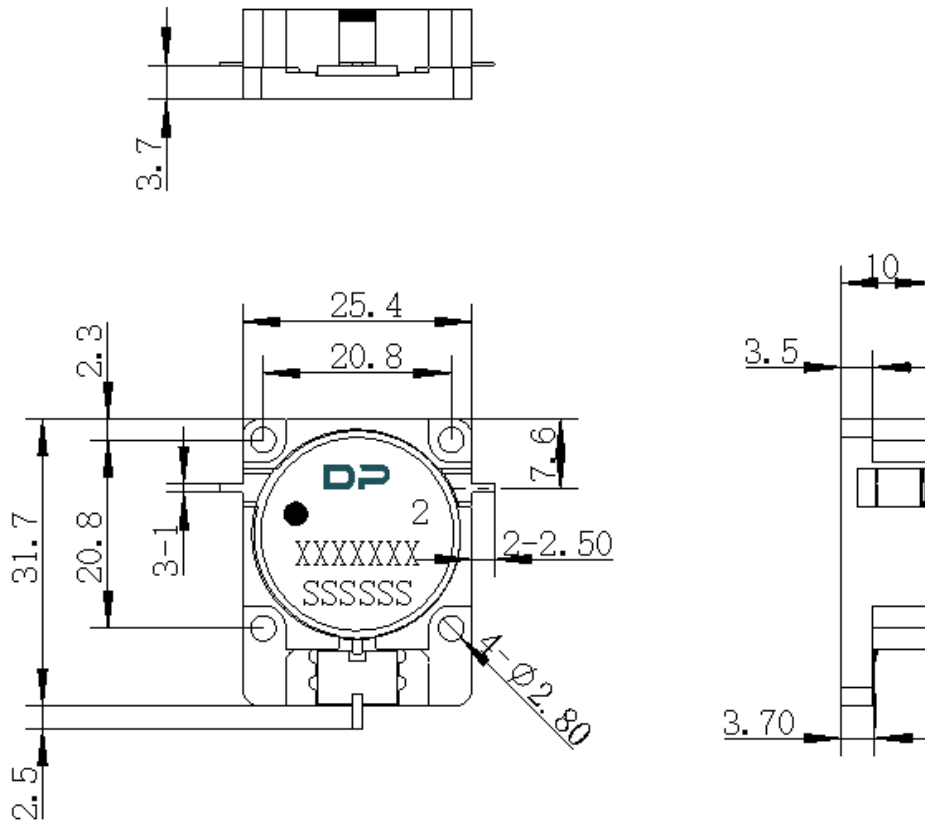

Unit: Millimeters

Notes:

1. The housing is nickel-plated and the tab is silver-plated.
2. Tolerance ± 0.2 mm unless otherwise specified.
3. Co-planarity Specification: 0.1 mm maximum.
4. Part Number, Lot Code, and Port Designation are printed on the top side of device.
5. The **XXXXXXX** on the label represents the part number
6. The **SSSSSS** on the label represents the serial number
7. The black dot on the label represents the input port