

Travelling Merchant: _____

DATASHEET

Standard: **T53-F519-10.00MHz-B**

P/N: _____

Plot			The Label
Drew	Audited	Approved	Stamp, please! Thanks!
Date: 2024.01.31			

Guangdong Dapu Telecom Technology Co.,Ltd

Building 5, No.24, Industrial East Road, Songshanhu Park, Dongguan, Guangdong, P.R. China

TEL: 0086-0769-88010888 FAX: 0086-0769-81800098



1. Electrical Parameters

MODEL: T53-F519-10.00MHz-B						
Item	Description	Parameters			Unit	Test Condition
		Min.	Typ.	Max.		
Output	Frequency	10.00			MHz	
	Output Waveform	Clipped Sine Wave				
	Vp-p	0.8			V	
	Load	10KΩ//10pF				
Frequency Stabilities	Frequency Tolerance vs. Operating Temperature Range	-0.5		+0.5	$\times 10^{-6}$	T_A varied from -40°C to 85°C , measurement referenced to frequency observed with $f_{\text{ref}}=(f_{\text{max}}+f_{\text{min}})/2$, $V_{\text{cc}}=3.3\text{V}$, $O_{\text{load}}=10\text{K}\Omega//10\text{pF}$, temperature variable speed less than 2°C per minute.
	Nominal Frequency Tolerance	-1		+1	$\times 10^{-6}$	Measurement referenced to frequency observed with $T_A=25^{\circ}\text{C}$, $V_{\text{cc}}=3.3\text{V}$ within 30 days after ex-works.
	Frequency Tolerance vs. Supply Voltage	-0.2		+0.2	$\times 10^{-6}$	measurement referenced to frequency observed $T_A=25^{\circ}\text{C}$, V_{cc} varied from 3.13V to 3.47V, and $O_{\text{Load}}=10\text{K}\Omega//10\text{pF}$.
	Frequency Tolerance vs. Load	-0.2		+0.2	$\times 10^{-6}$	5% load change measurement referenced to frequency observed with $T_A=25^{\circ}\text{C}$, $V_{\text{cc}}=3.3\text{V}$, and $O_{\text{Load}}=10\text{K}\Omega//10\text{pF}$.
	Aging Tolerance Per Day	-0.02		+0.02	$\times 10^{-6}$	$T_A=25^{\circ}\text{C}$, $V_{\text{cc}}=3.3\text{V}$, and after 1h of operation.
	Aging Tolerance 1 Year	-1		+1	$\times 10^{-6}$	
Power Supply	Operating Current			4	mA	@ 25°C , $V_{\text{cc}}=3.3\text{V}$, $O_{\text{Load}}=10\text{K}\Omega//10\text{pF}$.
	Supply Voltage	3.13	3.3	3.47	V	



Phase Noise	Phase Noise		-120	-115		100Hz
			-140	-135		1KHz
			-150	-145		10KHz
			-155	-150		100KHz
Environmental Conditions	Operable Temperature	-40		+85	°C	
	Storage Temperature	-55		+105	°C	
	ESD Level	Human Body Model,class2: 2000V to 4000V; ANSI/ESDA/JEDEC JS-001-2010.				
		Machine Model, class B: 200V to 400V; ANSI/ESDA/JEDEC JS-001-2010.				
	Moisture Sensitivity Level	Level 2.				
	Vibration	Test Condition: 0.75mm ;acceleration:10g;10Hz~2000Hz, one cycle per 30 min, test 2 hour. (3 times for each 3 directions X ,Y , Z).IEC 68-2-06 Test Fc.				
Shock	100g; 6ms; half sine wave (3 times for each 3 directions X ,Y , Z),IEC 68-2-27 Test Ea/Severity 50A.					

2. Mechanical Structure(mm)

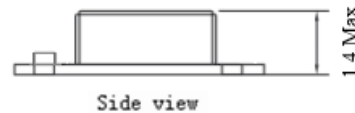
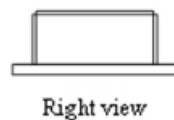
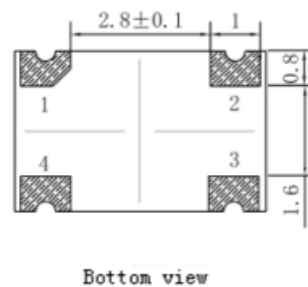
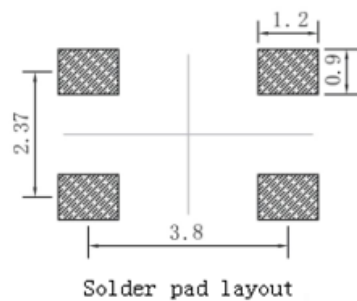

PIN FUNCTION

PIN	NOTATION	FUNCTION
1	NC	Not Connect
2	GND	GND
3	OUTPUT	RF Output
4	VCC	Supply Voltage

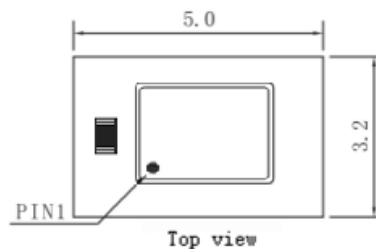

Note1: Tolerance $\pm 0.3\text{mm}$ without mark

Note2: Referential Weight 0.05g



3. Test Circuit

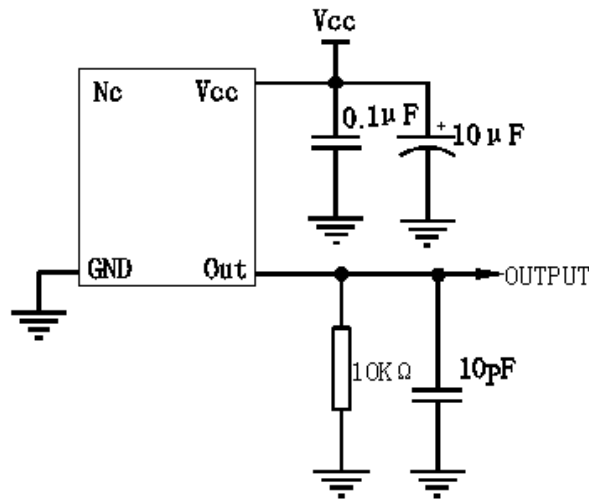

4. Reflow Soldering Curve (RoHS)

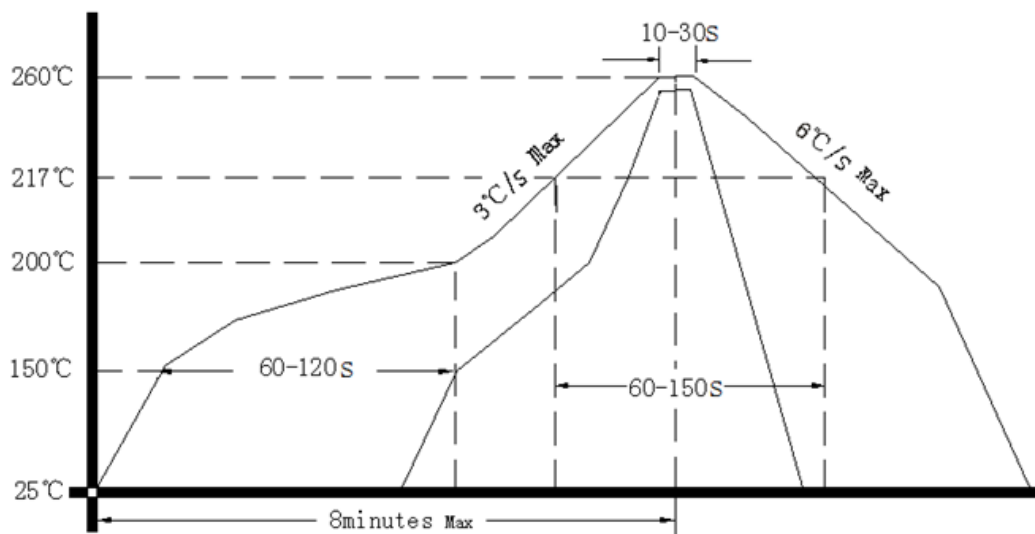

5. Package: Tape & Reel (mm)

