

To Customer: _____

Realtime Clock Module

INS5A4000

Datasheet

Document Version 1.0

Released on Jan 14th, 2025

Ordering Information

Manufacture Part Number	Product Name	Description	
INS5A4000ASGX	INS5A4000	Option A	$\pm 5\text{ppm}@-40^{\circ}\text{C}\sim+85^{\circ}\text{C}$
INS5A4000BSGX	INS5A4000	Option B	$\pm 8\text{ppm}@85^{\circ}\text{C}\sim+105^{\circ}\text{C}$
INS5A4000CSGX	INS5A4000	Option C	$\pm 50\text{ppm}@105^{\circ}\text{C}\sim+125^{\circ}\text{C}$
INS5A4000DSGX	INS5A4000	Option D	0.43uA(Typ)
INS5A4000ESGX	INS5A4000	Option E	LGA3225

Guangdong Dapu Telecom Technology Co., Ltd

No. 2, Kexin Road, Songshan Lake Park, Dongguan City, Dongguan City, Guangdong Province, PRC China

TEL:0086-0769-88010888

FAX:0086-0769-81800098

Index

1	OVERVIEW	3
2	KEY FEATURES	3
3	BLOCK DIAGRAM	4
4	PIN DEFINITION	4
5	ELECTRICAL CHARACTERISTICS	6
5.1	ABSOLUTE MAXIMUM RATINGS	6
5.2	RECOMMENDED OPERATING CONDITIONS.....	6
5.3	POWER-ON CHARACTERISTICS.....	7
5.4	FREQUENCY CHARACTERISTICS.....	7
5.5	DC CHARACTERISTICS	8
5.6	AC CHARACTERISTICS.....	10
6	REFERENCE DATA	11
7	REGISTERS	14
7.1	REGISTER LISTS	14
7.2	DETAILS OF REGISTERS.....	21
8	SPI INTERFACE	56
8.1	PIN DESCRIPTION.....	56
8.2	WRITE DATA	57
8.3	READ DATA.....	58
9	REFLOW SOLDERING CURVE	59
10	DIMENSIONS	60
11	PACKAGE	61
12	REVISION HISTORY	62

1 Overview

The INS5A4000 is a high-accuracy SPI bus interface real-time clock with low power consumption and wide operation temperature range. It embeds a 32.768KHz TCXO. The high precise temperature sensor and temperature compensated circuit ensure the high clock accuracy. It supports calendar (year, month, day, hour, minute, second) with a leap-year correction, time alarm, wakeup timer, time update interrupt, clock output, internal status output and two times stamp function that can record two times and dates when an event occurs. This product is capable of low power consumption and automotive applications.

2 Key Features

<ul style="list-style-type: none"> ● Low current consumption: 430nA (Typ.) 	<ul style="list-style-type: none"> ● AEC-Q100 compliant
<ul style="list-style-type: none"> ● High stability: $\pm 5\text{ppm @ } -40^{\circ}\text{C} \sim 85^{\circ}\text{C}$; $\pm 8\text{ppm @ } 85^{\circ}\text{C} \sim 105^{\circ}\text{C}$; $\pm 50\text{ppm @ } 105^{\circ}\text{C} \sim 125^{\circ}\text{C}$; 	<ul style="list-style-type: none"> ● Support calendar, time alarm, wakeup timer, time update interrupt, clock output, internal status output and time stamp function
<ul style="list-style-type: none"> ● Build-in TCXO: 32.768KHz 	<ul style="list-style-type: none"> ● Self-monitor function
<ul style="list-style-type: none"> ● Operation Temperature Range: $-40^{\circ}\text{C} \sim +125^{\circ}\text{C}$ 	<ul style="list-style-type: none"> ● Size: $3.2\text{mm} \times 2.5\text{mm} \times 1.0\text{mm}$ (LGA)
<ul style="list-style-type: none"> ● Communication Interface: SPI bus 	<ul style="list-style-type: none"> ● RoHS2.0, REACH & Halogen-free compliant
<ul style="list-style-type: none"> ● Power Supply Voltage: 1.6V~5.5V 	

3 Block Diagram

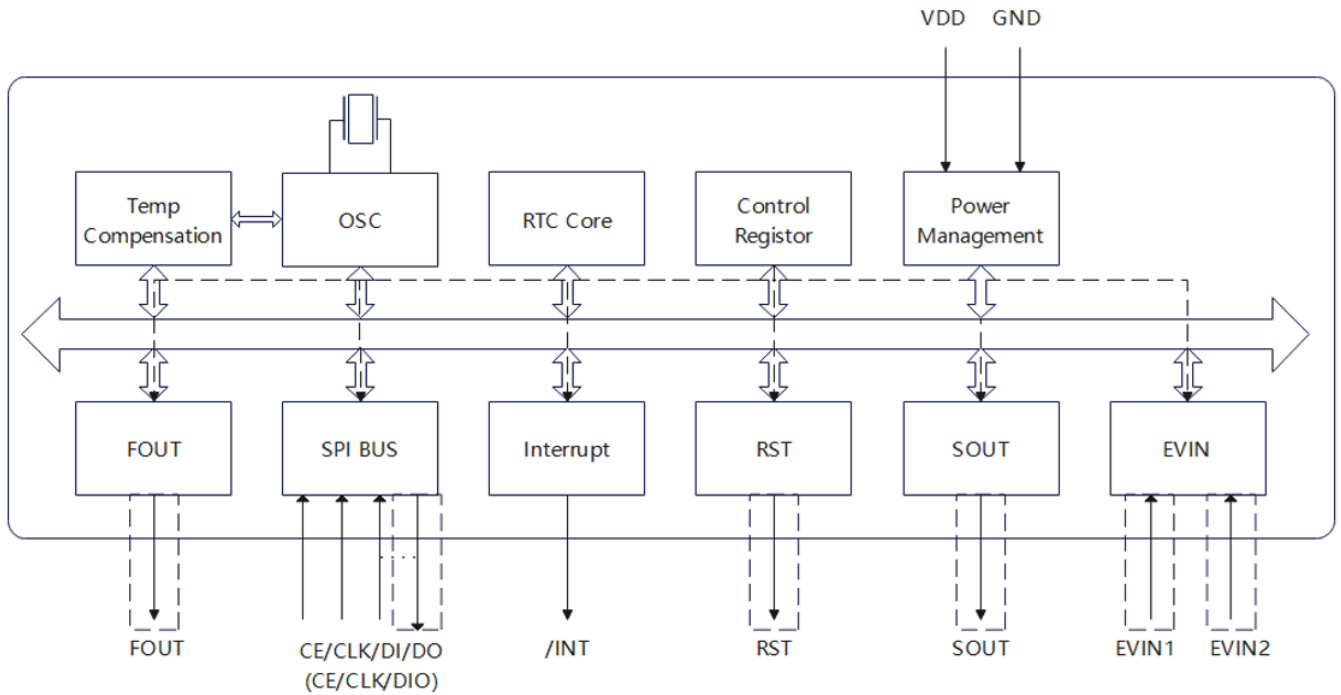

Figure1. Block Diagram

4 Pin definition

Option A		Option B	
Option C		Option D	

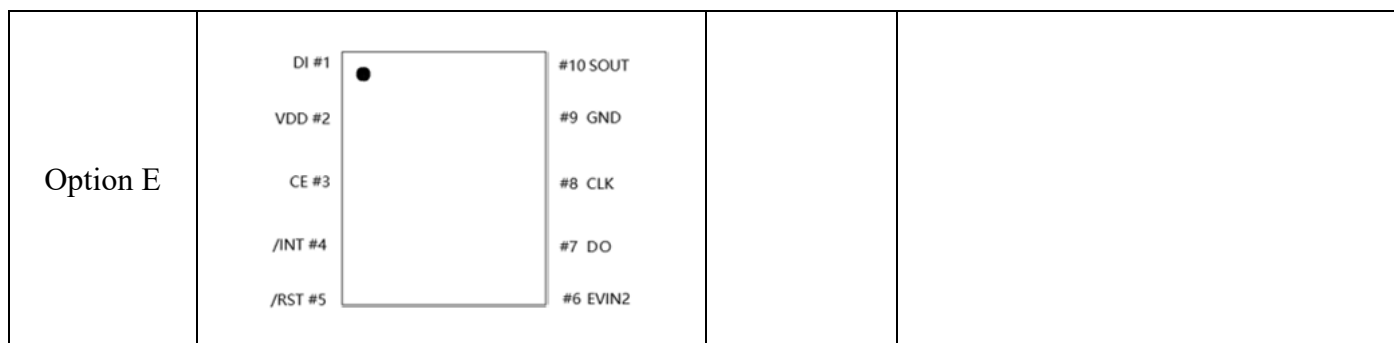

Table1. Pin Definition

Pin Name	I/O	Initial State	Description	INS5A4000				
				A	B	C	D	E
EVIN1	I	1MΩ PU	Time stamp trigger signal input pins, programmable PU and PD resistors and noise filters;	√	√	-	-	-
EVIN2	I	1MΩ PU		√	√	-	√	√
CLK	I	Hi-Z	3-wires/4-wires SPI serial clock input pin; Not allow to keep floating;	√	√	√	√	√
DIO	I/O	Hi-Z	3-wire SPI serial data input/output pin. Not allow to keep floating;	√	√	√	-	-
DO	O	Hi-Z	4-wire SPI serial data output pin;	-	-	-	√	√
DI	I	1MΩ PU	4-wire SPI serial data input pin;	-	-	-	√	√
CE	I	300KΩ PD	3-wire/4-wire SPI slave select input pin A pull-down resistor is included. Not allow to keep floating;	√	√	√	√	√
FOUT	O	Hi-Z	Clock output pin (CMOS) 32.768 kHz, 1024 Hz or 1 Hz clock output is selectable. Can be switched to the wakeup timer interrupt output (CMOS).	√	√	-	-	-
/INT	O	Hi-Z	Interrupt output pin (Open drain). The wakeup timer, time update, alarm, and/or event detection interrupt signals can be selected to output from this pin.	√	√	√	√	√
/RST	O	Hi-Z	Reset output pin (Open drain). A reset signal can be output to external devices when a VDD voltage drop below the predefined value is detected. When the VDD voltage is restored (a VDD voltage rise to the predefined value is detected), the reset output is cancelled (set to a Hi-Z state) after at least 60ms and less than 185ms from the detection.	-	√	-	-	√
SOUT	O	Hi-Z	Status output pin One of the internal flags (TF/AF/UF/EF/VTMPLF/VLF/'H'/'L') can be selected to output its status from this pin. The output signal polarity can also be selected.	-	-	-	√	√
VDD	-	-	Main power supply pin;	√	√	√	√	√
GND	-	-	Ground pin;	√	√	√	√	√

Notes:

I: Input

O: Output

I/O: Input / output

PU: Pull Up

PD: Pull Down

√ : This pin is available

-: This pin is unavailable

- Do not leave the unused input and input/output pins open nor apply an intermediate potential to them if the internal pull-up or -down resistor is not enabled.
- Leave the output pins (FOUT, SOUT, /INT, and DO) open when they are not used.
- When the reset output function is not use in the model with /RST pin function, the /RST pin should connect to a GND or keep floating.
- N.C. of PIN1 and PIN6 initial status is 1MΩ PU, do not connect to GND, otherwise is will add additional power consumption;
- N.C. PIN5 should keep floating or connect GND.
- N.C. PIN10 is Hi-Z output, it can connect to 'H', 'L' or keep floating.

5 Electrical Characteristics

5.1 Absolute Maximum Ratings

Table2. Absolute Maximum Ratings

Parameter	Symbol	Value			Unit	Notes
		Min.	Typ.	Max.		
Power Supply Voltage	V _{DD}	-0.3		6.5	V	
Input Voltage	V _{IN}	0.3		6.5	V	FOE, CE, DI, DIO, EVIN1, EVIN2
Clock Output Voltage	V _{OUT}	0.3		6.5	V	/INT, /RST, FOUT, SOUT, DIO, DO
Storage temperature	T _{STG}	-55		125	°C	

5.2 Recommended Operating Conditions

Table3. Recommended Operating Conditions

Parameter	Symbol	Value			Unit	Notes
		Min.	Typ.	Max.		
Operating supply voltage	V _{DD}	1.6	3.0	5.5	V	
Power on voltage	V _{UP}	2	3.0	5.5	V	Power on voltage*
Interface supply voltage	V _{COM}	1.6	3.0	5.5	V	SPI communication voltage
Temperature compensation voltage	V _{TEMP}	1.8	3.0	5.5	V	VDD voltage that can keep temperature compensation operation
Operation temperature	T _{OPR}	-40	25	125	°C	

*Note:

1. During the power on and oscillation starting time, a voltage more than 2.0V must be provided to ensure the oscillation circuit to a stable state.
2. A bypass capacitor for noise suppression must be connected as close to the power supply pin as possible.
3. After the power supply is removed or power off, ensure that VDD=GND for more than 10 seconds before next power on cycle.

5.3 Power-On Characteristics

Table4. Power-On Characteristics

Parameter	Symbol	Value			Unit	Notes
		Min.	Typ.	Max.		
Power supply rise time 1	T _{R1}	0.5	-	100	ms/V	Voltage slope while the VDD voltage is rising from GND to V _{UP} .
Power supply rise time 2	T _{R2}	0.5	-	100	ms/V	Voltage slope while the VDD voltage is rising from VDET on /RST mode.
Access waiting time after power on	T _{CL}	300	-	-	ms	Time after VDD reaches V _{UP} (Min.) until accessing can be started
Access end hold time before power off	T _{CD}	0	-	-	ms	The waiting time until the VDD voltage starts dropping in the T _F voltage slope after the end of access
Power supply fall time	T _F	0.5		100	ms/V	Voltage slope while the VDD voltage is dropping

5.4 Frequency Characteristics

Table5. Frequency Characteristics

Parameter	Symbol	Value			Unit	Notes
		Min.	Typ.	Max.		
Frequency stability	$\Delta f/f$			± 5	ppm	@ -40°C to +85°C, VDD=3V
				± 8		@ 85°C to +105°C, VDD=3V
				± 50		@ 105°C to +125°C, VDD=3V
Frequency vs voltage	f/V	-1		1	ppm/V	@25 °C, VDD = 1.8 V to 5.5 V
Oscillation start time	t _{STA}			1	s	@25°C, VDD=2V~5.5V
				3	s	@-40°C to 125°C, VDD=2V~5.5V
Year Aging	f _a	-5		+5	ppm	@25°C, First year
FOUT duty cycle	t _{w/t}	40	50	60	%	

Note: If there is no special indication, the test conditions are GND = 0V, VDD = 3V, T_{OPR} = -40°C~+125°C

5.5 DC Characteristics

Table6. DC Characteristics

Parameter	Symbol	Value			Unit	Notes
		Min.	Typ.	Max		
Average Current consumption1	I _{DD1}	-	0.48	2.2	uA	V _{DD} =5.0V T _{OPR} =25°C / INT = Hi-Z, FOUT: Output OFF (Hi-Z) Temperature compensation interval: 2.0 s No /RST pin, SCL, SDA = H, CE = L
Average Current consumption2	I _{DD2}	-	0.43	2.0		
Average Current consumption3	I _{DD3}	-	3.7	8	uA	V _{DD} =5.0V T _{OPR} =25°C /INT = Hi-Z FOUT: 32 kHz output, CL = 0 pF Temperature compensation interval: 2.0 s No /RST pin, SCL, SDA = H, CE = L
Average Current consumption4	I _{DD4}	-	2	6		
Average Current consumption5	I _{DD5}	-	8.0	17	uA	V _{DD} =5.0V T _{OPR} =25°C /INT= Hi-Z FOUT: 32 kHz output, CL= 30 pF Temperature compensation interval: 2.0 s No /RST pin, SCL, SDA = H, CE = L
Average Current consumption6	I _{DD6}	-	5.0	12		
Average Current consumption7	I _{DD7}	-	0.45	2.15	uA	V _{DD} =5.0V T _{OPR} =25°C /INT = Hi-Z FOUT: Output OFF (Hi-Z) Temperature compensation circuit: OFF No /RST pin, SCL, SDA = H, CE = L
Average Current consumption8	I _{DD8}	-	0.4	1.95		
Average Current consumption9	I _{DD9}	-	28	80	uA	V _{DD} =5.0V T _{OPR} =25°C /INT = Hi-Z FOUT: Output OFF (Hi-Z) The temperature compensation operation: peak performance No /RST pin, SCL, SDA = H, CE = L
Average Current consumption10	I _{DD10}	-	25	60		
Average Current consumption11	I _{DD11}	-	1.5	3	uA	V _{DD} =5.0V T _{OPR} =25°C /INT = Hi-Z, FOUT: Output OFF (Hi-Z) Temperature compensation interval: 2.0 s With /RST pin, during output cancelled (Hi-Z) SCL, SDA = H, CE = L
Average Current consumption12	I _{DD12}	-	0.45	2.8		
Voltage Low Detection	V _{LF}	1	1.2	1.4	V	V _{LF} detection voltage. When V _{DD} drop below V _{LF} , device will reset.
VDD Voltage Detection1	V _{DET1}	1.4	1.6	1.8	V	Temperature compensation stop detection voltage
VDD Voltage Detection2	-V _{DET2}	2.1	2.4	2.7	V	V _{DD} drop detection voltage for /RST signal generation
	+V _{DET2}	2.2	2.5	2.8	V	V _{DD} rise detection voltage for /RST signal release
High-level input voltage	V _{IH}	0.8*V _{DD}	-	5.5	V	CE, CLK, DIO, DI, EVIN _n

Parameter	Symbol	Value			Unit	Notes	
		Min.	Typ.	Max			
Low-level input voltage	V _{IL}	0.3	-	0.2*V _{DD}	V		
High-level output voltage	V _{OH1}	4.5	-	5.5	V	V _{DD} =5.5V, I _{OH} = -1mA	FOUT, SOUT, DIO, DO
	V _{OH2}	2.2	-	3.0		V _{DD} =3.0V, I _{OH} = -1mA	
	V _{OH3}	2.9	-	3.0		V _{DD} =3.0V, I _{OH} = -100uA	
Low-level output voltage	V _{OL1}	0	-	0.5	V	V _{DD} =5.5V, I _{OL} = 1mA	FOUT, SOUT
	V _{OL2}	0	-	0.8		V _{DD} =3.0V, I _{OL} = 1mA	
	V _{OL3}	0	-	0.1		V _{DD} =3.0V, I _{OL} = 100uA	
	V _{OL4}	0	-	0.25	V	V _{DD} =5.5V, I _{OL} = 1mA	/INT, /RST, DO, DIO
	V _{OL5}	0	-	0.4		V _{DD} =3.5V, I _{OL} = 1mA	
Input leakage current	I _{LK1}	2	-	8	uA	Input voltage = GND	EVINn
	I _{LK2}	-0.5	-	0.5		Input voltage = VDD	
	I _{LK3}	-0.5	-	0.5		Input voltage = GND	CE
	I _{LK4}	10	-	20		Input voltage = VDD	
	I _{LK5}	-0.5	-	0.5		Input voltage = GND	DIO, CLK, DI
	I _{LK6}	-0.5	-	0.5		Input voltage = VDD	
Output leakage current	I _{OZ}	-0.5	-	0.5	uA	Input voltage = VDD or GND	/RST, /INT, FOUT, SOUT, DIO
Open drain output pin pull-up voltage	V _{PUP1}	-	-	5.5	V	/INT	
	V _{PUP2}	VDD	-	5.5	V	/RST	
Pull-up resistance	R _{UP1}	100	500	2000	KΩ	EVINn, VDD=3V, 500KΩ setting	
	R _{UP2}	200	1000	4000	KΩ	EVINn, VDD=3V, 1MΩ setting	
	R _{UP3}	200	1000	4000	KΩ	DI	
	R _{UP4}	200	1000	4000	MΩ	Option C: N.C. pin1 / pin6	
Pull-down resistance	R _{DOWN1}	100	500	2000	KΩ	EVINn, VDD=3V, 500KΩ setting	
	R _{DOWN2}	50	300	600	KΩ	CE	

Note: If there is no special indication, the test conditions are GND=0V, VDD=3V, T_{OPR}=-40°C~+125°C.

6 Reference Data

IDD1/2(uA) vs T_{OPR}(°C) :

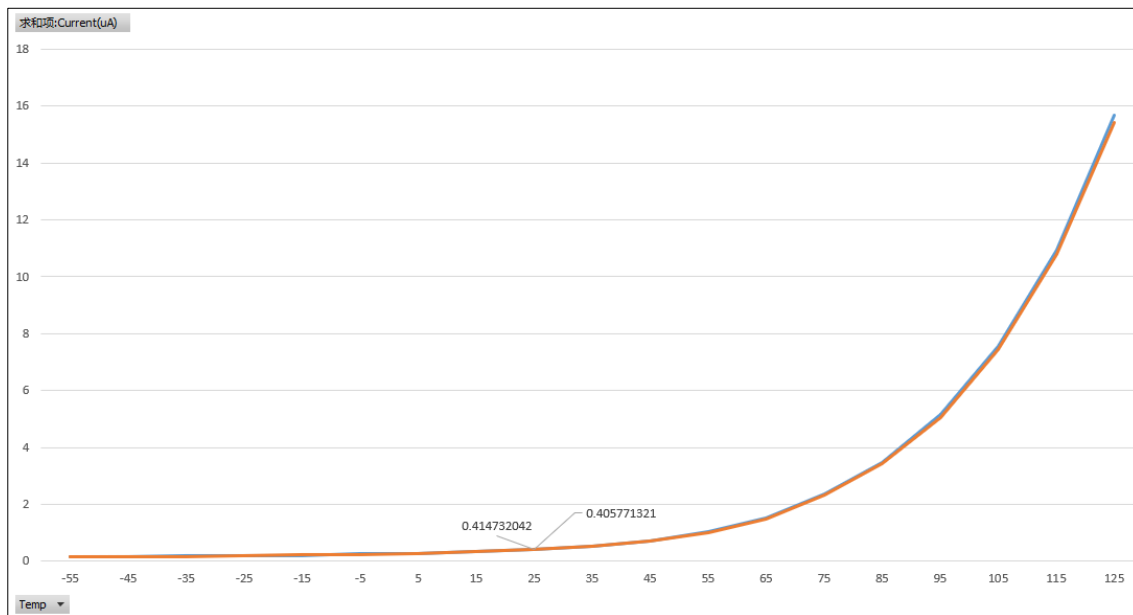

IDD3/4(uA) vs T_{OPR}(°C) :

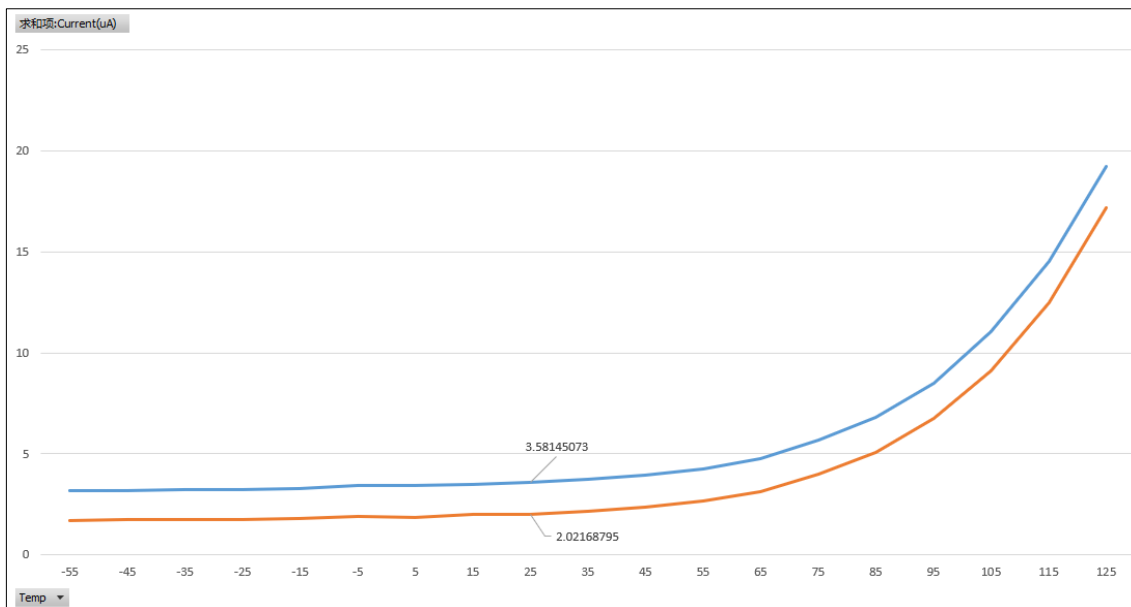

IDD5/6(uA) vs T_{OPR}(°C) :

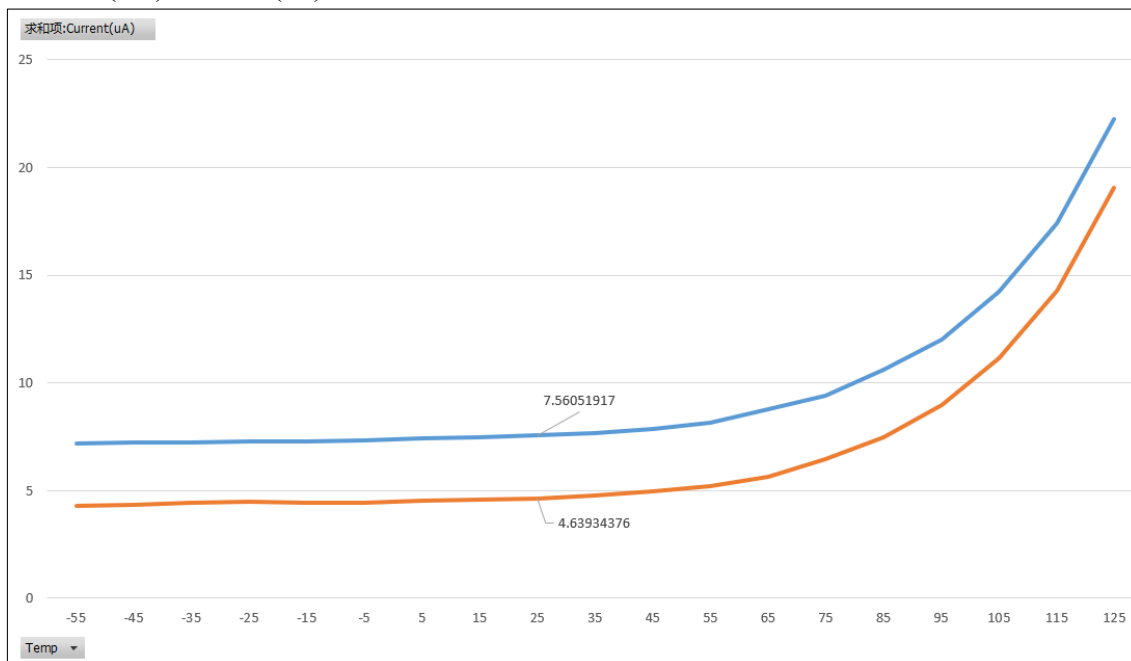

IDD7/8(uA) vs T_{OPR}(°C) :

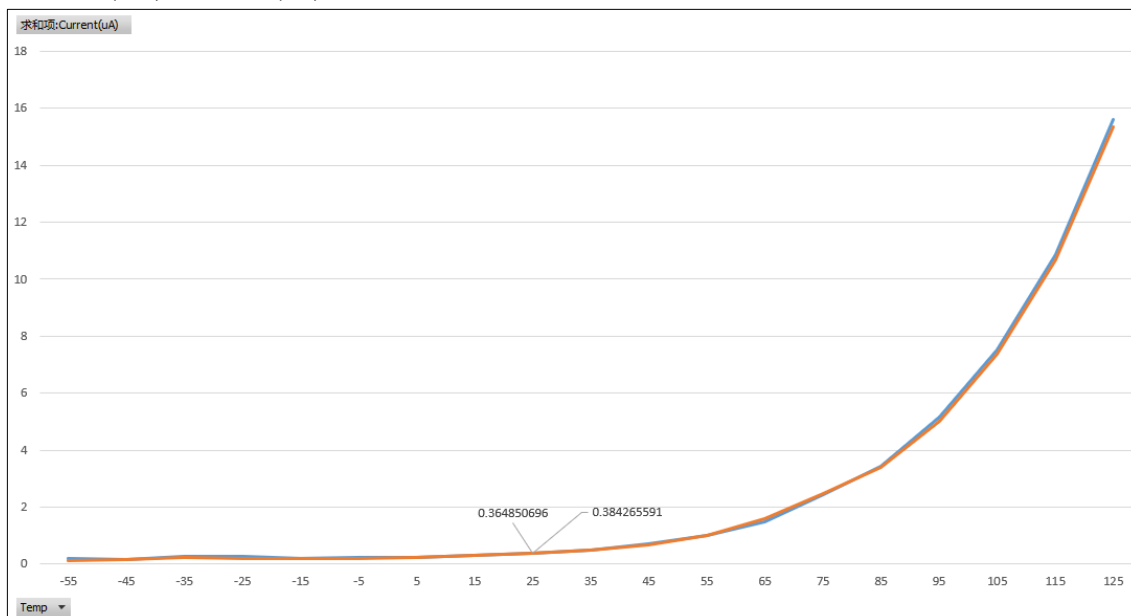

IDD9/10(uA) vs T_{OPR}(°C) :

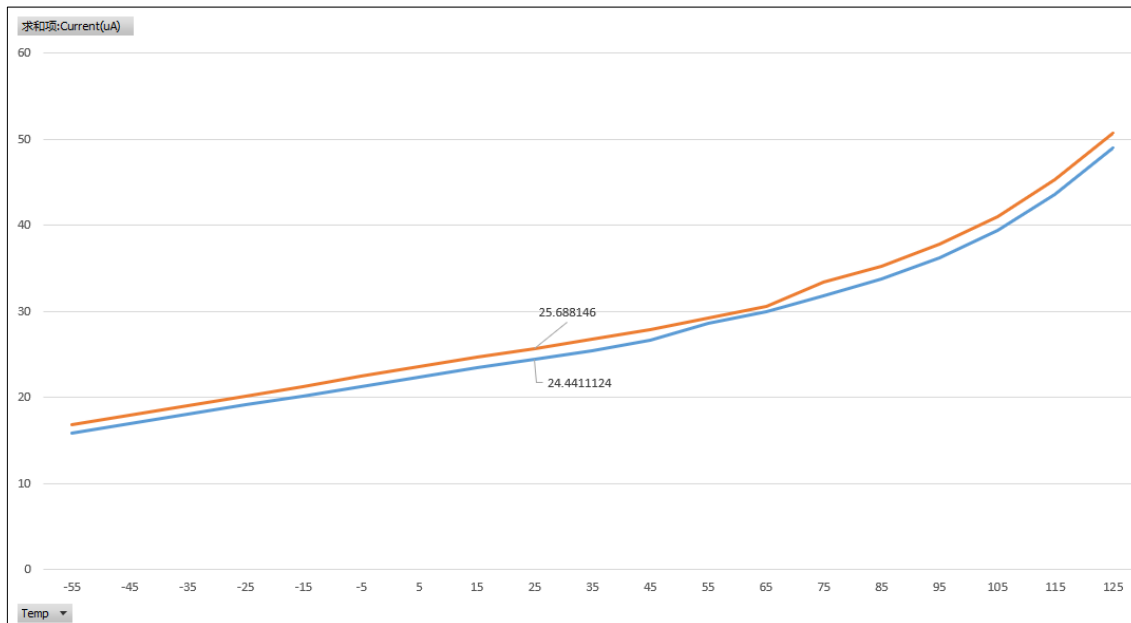

IDD11/12(uA) vs T_{OPR}(°C) :

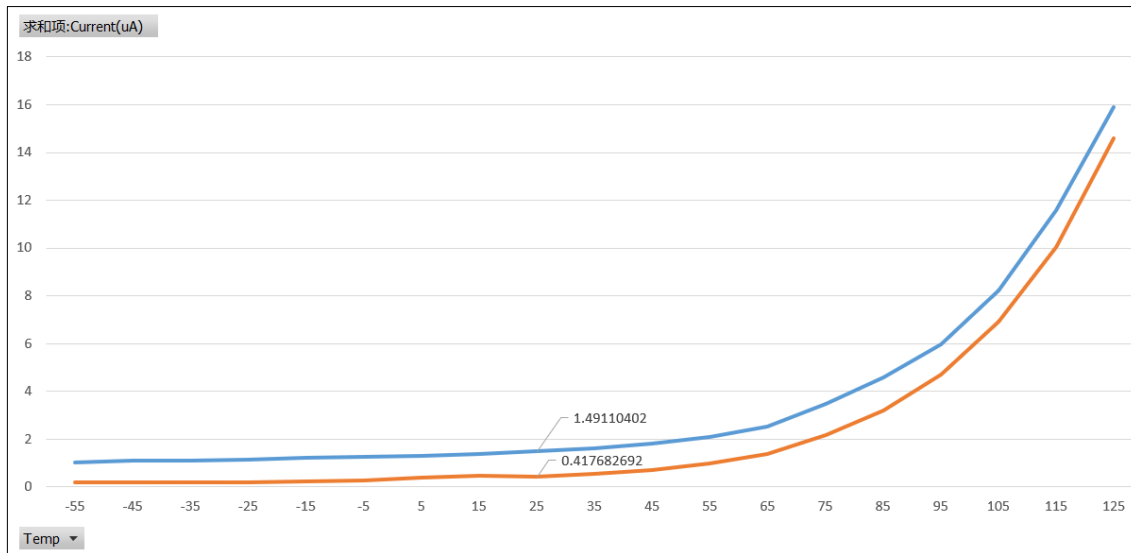

7 Registers

7.1 Register Lists

Symbol meaning

Bit name = 0: This bit is not writable, and the read value is always 0.

Bit name = x: This bit is not writable, and the read value is undefined.

Bit name = (GP): This is a general-purpose bit that allows writing 0 and 1 as well as reading the contents.

Notes:

- The address values indicate {bank number, address in bank}. (Example: 0x0F = Bank 0, Address 0xF)
- The registers must be accessed in eight-bit units.
- Be sure to avoid writing/reading data to/from an address not listed in the register tables.

Address	Function	bit7	bit6	bit5	bit4	bit3	bit2	bit1	bit0	
0x00	SEC BCD mode	0	SEC_H[2:0]		SEC_L[3:0]					
	SEC_BIN0 BIN mode	SEC_BIN[7:0]								
0x01	SEC BCD mode	0	MIN_H[2:0]		MIN_L[3:0]					
	SEC_BIN1 BIN mode	SEC_BIN[15:8]								
0x02	HOUR BCD mode	0	0	HOUR_H[1:0]		HOUR_L[3:0]				
	SEC_BIN2 BIN mode	SEC_BIN[23:16]								
0x03	WEEK BCD mode	0	WEEK[6:0]							
	SEC_BIN3 BIN mode	SEC_BIN[31:24]								
0x04	DAY BCD mode	0	0	DAY_H[1:0]		DAY_L[3:0]				
	SEC_BIN4 BIN mode	0	0	0	0	0	0	0	SEC_BIN[32]	
0x05	MONTH BCD mode	0	0	0	MONTH_H	MONTH_L[3:0]				
	NOT USED BIN mode	0	0	0	0	0	0	0	0	
0x06	YEAR	YEAR_H[3:0]				YEAR_L[3:0]				
	NOT USED BIN mode	0	0	0	0	0	0	0	0	

0x07	ALM_MIN	XMAE	MALM_H[2:0]			MALM_L[3:0]			
	NOT USED BIN mode	(GP)	(GP)	(GP)	(GP)	(GP)	(GP)	(GP)	(GP)
0x08	ALM_HOUR	XHAE	(GP)	HALM_H[1:0]		HALM_L[3:0]			
	NOT USED BIN mode	(GP)	(GP)	(GP)	(GP)	(GP)	(GP)	(GP)	(GP)
0x09	ALM_WEEKDAY	XWAE	WKALM[6:0]						
			(GP)	DALM_H[1:0]		DALM_L[3:0]			
	NOT USED BIN mode	(GP)	(GP)	(GP)	(GP)	(GP)	(GP)	(GP)	(GP)
0x0A	WTCNT_L Timer Counter Low	WTCNT[7:0]							
0x0B	WTCNT_M Timer Counter Medium	WTCNT[15:8]							
0x0C	WTCNT_H Timer Counter High	WTCNT[23:16]							
0x0D	TCTL Timer Control	FSEL[1:0]		USEL[0]	TE	WADA	○	TSEL[1:0]	
0x0E	INTF Status Flag	PORF	OSCSTPF	UF	TF	AF	EVF	VLF	VTMPLF
0x0F	TSTP_INTE Contrl Register	CSEL[1:0]		UIE	TIE	AIE	EIE	○	STOP

BANK1

Address	Function	bit7	bit6	bit5	bit4	bit3	bit2	bit1	bit0
0x10	SUBSEC_L Sub-Second Low	SUBSEC[1:0]		○	○	○	○	○	○
0x11	SUBSEC_H Sub-Second High	SUBSEC[9:2]							
0x12	SEC_MIR(0x00) BCD mode	○	SEC_H[2:0]			SEC_L[3:0]			
	SEC_BIN0 BIN mode	SEC_BIN[7:0]							
0x13	MIN_MIR(0x01) BCD mode	○	MIN_H[2:0]			MIN_L[3:0]			
	SEC_BIN1 BIN mode	SEC_BIN[15:8]							
0x14	HOUR_MIR(0x02) BCD mode	○	○	HOUR_H[1:0]		HOUR_L[3:0]			

	SEC_BIN2 BIN mode	SEC_BIN[23:16]							
0x15	WEEK_MIR(0x03) BCD mode	○	WEEK[6:0]						
	SEC_BIN3 BIN mode	SEC_BIN[31:24]							
0x16	DAY_MIR(0x04) BCD mode	○	○	DAY_H[1:0]		DAY_L[3:0]			
	SEC_BIN4 BIN mode	○	○	○	○	○	○	○	SEC_BIN[32]
0x17	MONTH_MIR(0x05) BCD mode	○	○	○	MONTH_H	MONTH_L[3:0]			
	NOT USED BIN mode	○	○	○	○	○	○	○	○
0x18	YEAR_MIR(0x06) BCD mode	YEAR_H[3:0]				YEAR_L[3:0]			
	NOT USED BIN mode	○	○	○	○	○	○	○	○
0x19	OFS_SUBSEC_H	OFS_ SUBSEC[10]	(GP)	(GP)	OFS_SUBSEC[9:5]				
0x1A	OFS_SUBSEC_L	OFS_SUBSEC[4:0]				○	OFSIN	OFSEN	
0x1B	DIG_TRIM_H	DTRIM[8:1]							
0x1C	DIG_TRIM_L	DTRIM[0]	○	○	○	○	○	○	DTRIMEN
0x1D	TCTL_MIR(0x0D) Timer Control	FSEL[1:0]		USEL0	TE	WADA	○	TSEL[1:0]	
0x1E	INTF_MIR(0x0E) Status Flag	PORF	OSCSTPF	UF	TF	AF	EVF	VLF	VTMPLF
0x1F	CNTSEL Counter Select	○	○	○	○	○	ACC BCD	BINCNT EN	BCDCNT EN

BANK2

Address	Function	bit7	bit6	bit5	bit4	bit3	bit2	bit1	bit0
0x20	EVIN_EN Event Input Enable	○	○	○	EVIN2 CPEN	EVIN1 CPEN	○	EVIN2 EN	EVIN1 EN
0x21	EVIN1_CFG EVIN1_Configuration	○	○	○	PUPD[2:0]			POL[1:0]	
0x22	EVIN1_FLT EVIN1 Noise Filter	○	○	FLT[5:0]					
0x23	EVIN2_CFG EVIN2_Configuration	○	○	○	PUPD[2:0]			POL[1:0]	
0x24	EVIN2_FLT EVIN2 Noise Filter	○	○	FLT[5:0]					

0x27	BUF1_CFG1 BUF1 Configuration 1	BINSEL	OVWEN	○	○	○	FULL IEN	EMPT IEN	OVW IEN
0x28	BUF1_STAT BUF1 Status	FULLF	EMPTF	○	○	○	○	○	OVWF
0x29	BUF1_CFG2 BUF1 Configuration 2	○	SRAM MOD	○	○	○	○	○	○

BANK3

Address	Function	bit7	bit6	bit5	bit4	bit3	bit2	bit1	bit0
0x30	ALM_SEC Second Alarm	XSAE	SALM_H[2:0]			SALM_L[3:0]			
0x31	ALM_MIN_MIR(07) Mirrored Minute Alarm	XMAE	MALM_H[2:0]			MALM_L[3:0]			
0x32	ALM_HOUR_MIR(08) Mirrored Minute Alarm	XHAE	(GP)	HALM_H [1:0]		HALM_L[3:0]			
0x33	ALM_WEEKDAY_MIR(09) Mirrored Day-of-Week Alarm	XWAE	WKALM[6:0]						
			(GP)	DALM_H [1:0]		DALM_L[3:0]			
0x34	UPDISEL Time Update Interrupt Select	○	○	○	○	○	○	USEL[1]	○
0x38	WTICFG Wakeup Timer Interrupt Configuration	PIN MUX[1:0]		RST OPT[1:0]		WT ONETIM	TSEL2	WTIOUT	UPDOWN MOD
0x39	WTCTL Wakeup Timer Control	WT RST	EXWT RSTEN	WT RSTWIN[1:0]		WT MODSEL	WT STOPCTL	○	WT STOP
0x3A	WTCNT_L_MIR(0A) Timer Counter Low	WTCNT[7:0]							
0x3B	WTCNT_M_MIR(0B) Timer Counter Medium	WTCNT[15:8]							
0x3C	WTCNT_H_MIR(0C) Timer Counter High	WTCNT[23:16]							
0x3D	TCTL_MIR(0D) Timer Control	FSEL[1:0]		USEL0	TE	WADA	○	TSEL[1:0]	
0x3E	INTF_MIR(0E) Status Flag	PORF	OSCSTPF	UF	TF	AF	EVF	VLF	VTMPLF
0x3F	TSTP_INTE_MIR(0F) Contrl Register	CSEL[1:0]		UIE	TIE	AIE	EIE	○	STOP

BANK4

Address	Function	bit7	bit6	bit5	bit4	bit3	bit2	bit1	bit0
---------	----------	------	------	------	------	------	------	------	------

0x41	WRCMD_CFG Write Command Configuration	EVCNT CLREN	○	○	BUFIF CLREN	○	○	○	CMDTRG EN
0x42	WRCMD_TRG Write Command Trigger	WRTRG[7:0]							
0x43	EVNT_INTE Event interrupt Enable	○	EVIN2I EN	EVIN1I EN	RSTOIE N	○	VTMPLI EN	○	OSCSTP I EN
0x44	CAP_EN Capture Enable	○	○	○	RSTO CPEN	○	VTMPL CPEN	○	OSCSTP C PEN
0x45	INTF_MIR(OE) Status Flag	PORF	OSCST PF	UF	TF	AF	EVF	VLF	VTMPLF
0x46	BUF_INTF Buffer Interrupt Factor	○	○	BUFIF	RSTOF	○	○	○	○
0x47	EVNT_INTE Event interrupt Factor	○	EVIN2F	EVIN1F	RSTOEV F	○	VTMPLE VF	○	OSCSTP E VF
0x4B	CL_CONTROL_OF FSET	CL_CONTROL_OFFSET[7:0]							
0x4C	TEMP_CL_FLT	○	○	○	○	CL_ALFA_CFG[1: 0]	TEMP_ALFA_CFG[1:0]		
0x4D	SOFT_RST1	SOFT_RST1[7:0]							
0x4E	SOFT_RST2	SOFT_RST2[7:0]							

BANK5

Address	Function	bit7	bit6	bit5	bit4	bit3	bit2	bit1	bit0
0x51	EVIN1 EVCNT EVIN1 Event Counter	○	○	EVCNT[5:0]					
0x52	EVIN2 EVCNT EVIN2 Event Counter	○	○	EVCNT[5:0]					
0x54	EVINMON EVIN Monitor	○	EVIN2MON	EVIN1MON	○	○	○	○	○

0x55	SOUTCTL SOUT Control	DCE	DC	○	○	SIGINV	SOUT[2:0]
------	-------------------------	-----	----	---	---	--------	-----------

BANK6/7(when reading time stamp(BCD) data in direct mode)

Setting when time stamp data is captured: BUF1_CFG1.BINSEL bit=0, CNTSEL.BCDCNTTE bit=1

Address	Function	bit7	bit6	bit5	bit4	bit3	bit2	bit1	bit0	
0x60 0x70	TIMESTAMP_SUBSEC_L SUBSEC Time Stamp Data Low	SUBSEC[1:0]		X	X	X	X	X	X	
0x61 0x71	TIMESTAMP_SUBSEC_H SUBSEC Time Stamp Data High	SUBSEC[9:2]								
0x62 0x72	TIMESTAMP_SEC SEC Time Stamp Data	X	SEC_H[2:0]			SEC_L[3:0]				
0x63 0x73	TIMESTAMP_MIN MIN Time Stamp Data	X	MIN_H[2:0]			MIN_L[3:0]				
0x64 0x74	TIMESTAMP_HOUR HOUR Time Stamp Data	X	X	HOUR_H[2:0]		HOUR_L[3:0]				
0x65 0x75	TIMESTAMP_DAY DAY Time Stamp Data	X	X	DAY_H[2:0]		DAY_L[3:0]				
0x66 0x76	TIMESTAMP_MONTH MONTH Time Stamp Data	X	X	X	MONTH_H	MONTH_L[3:0]				
0x67 0x77	TIMESTAMP_YEAR YEAR Time Stamp Data	YEAR_H[3:0]				YEAR_L[3:0]				
0x68 0x78	TIMESTAMP_EVSTAT Event Status Time Stamp Data	X	EVIN2 POL	EVIN1 POL	X	RSTO STAT	VTMPL STAT	X	OSCSTP STAT	
0x69 0x79	TIMESTAMP_TRG Time Stamp Trigger Factor	OVWF STAT*	EVIN2 TRG	EVIN1 TRG	WRCMD TRG	RSTO TRG	VTMPL TRG	X	OSCSTP TRG	

* OVWFSTAT exists only in Address 0x79 (not exist in Address 0x69).

BANK6/7(when reading time stamp(BIN) data in direct mode)

Setting when time stamp data is captured: BUF1_CFG1.BINSEL bit=1, CNTSEL.BINCNTTE bit=1

Address	Function	bit7	bit6	bit5	bit4	bit3	bit2	bit1	bit0
0x60 0x70	TIMESTAMP_SUBSEC_L SUBSEC Time Stamp Data Low	SUBSEC[1:0]		X	X	X	X	X	X
0x61 0x71	TIMESTAMP_SUBSEC_H SUBSEC Time Stamp Data High	SUBSEC[9:2]							

0x62 0x72	TIMESTAMP_SEC SEC Time Stamp Data	SUB_BIN[7:0]							
0x63 0x73	TIMESTAMP_MIN MIN Time Stamp Data	SUB_BIN[15:8]							
0x64 0x74	TIMESTAMP_HOUR HOUR Time Stamp Data	SUB_BIN[23:16]							
0x65 0x75	TIMESTAMP_DAY DAY Time Stamp Data	SUB_BIN[31:24]							
0x66 0x76	TIMESTAMP_MONTH MONTH Time Stamp Data	X	X	X	X	X	X	X	SUB_BIN[32]
0x67 0x77	TIMESTAMP_YEAR YEAR Time Stamp Data	X	X	X	X	X	X	X	X
0x68 0x78	TIMESTAMP_EVSTAT Event Status Time Stamp Data	X	EVIN2 POL	EVIN1 POL	X	RSTO STAT	VTMPL STAT	X	OSCSTP STAT
0x69 0x79	TIMESTAMP_TRG Time Stamp Trigger Factor	OVWF STAT*	EVIN2 TRG	EVIN1 TRG	WRCMD TRG	RSTO TRG	VTMPL TRG	X	OSCSTP TRG

* OVWFSTAT exists only in Address 0x79 (not exist in Address 0x69).

BANK6(SRAM mode)

Setting when accessing to the SRAM: BUF1_CFG2.SRAMMOD bit=1

Address	Function	bit7	bit6	bit5	bit4	bit3	bit2	bit1	bit0
0x60	SRAM Address 0x00	bit7	bit6	bit6	bit4	bit3	bit2	bit1	bit0
0x61	SRAM Address 0x01								
0x62	SRAM Address 0x02								
0x63	SRAM Address 0x03								
0x64	SRAM Address 0x04								
0x65	SRAM Address 0x05								
0x66	SRAM Address 0x06								
0x67	SRAM Address 0x07								
0x68	SRAM Address 0x08								
0x69	SRAM Address 0x09								
0x6A	SRAM Address 0x0A								
0x6B	SRAM Address 0x0B								
0x6C	SRAM Address 0x0C								
0x6D	SRAM Address 0x0D								
0x6E	SRAM Address 0x0E								
0x6F	SRAM Address 0x0F								
0x70	SRAM Address 0x10	bit7	bit6	bit6	bit4	bit3	bit2	bit1	bit0
0x71	SRAM Address 0x11								
0x72	SRAM Address 0x12								
0x73	SRAM Address 0x13								

0x74	SRAM Address 0x14							
0x75	SRAM Address 0x15							
0x76	SRAM Address 0x16							
0x77	SRAM Address 0x17							
0x78	SRAM Address 0x18							
0x79	SRAM Address 0x19							
0x7A	SRAM Address 0x1A							
0x7B	SRAM Address 0x1B							
0x7C	SRAM Address 0x1C							
0x7D	SRAM Address 0x1D							
0x7E	SRAM Address 0x1E							
0x7F	SRAM Address 0x1F							

7.2 Details of Registers

[BCD mode] indicates that the register can only be used in BCD mode (CNTSEL.ACCBCD bit = 1, CNTSEL.BCDCNTEN bit = 1).

[BIN mode] indicates that the register can only be used in BIN mode (NTSEL.ACCBCD bit = 0, CNTSEL.BINCNTEN bit = 0).

0x00:SEC(Second Data) [BCD mode]

Bit No.	bit7	bit6	bit5	bit4	bit3	bit2	bit1	bit0
Bit Name	○	SEC_H[2:0]			SEC_L[3:0]			
Initial value	0	0	0	0	0	0	0	0
R/W	R	R/W	R/W	R/W	R/W	R/W	R/W	R/W

SEC Valid value: 0x00~0x09, 0x10~0x19, 0x20~0x29, 0x30~0x39, 0x40~0x49, 0x50~0x59;

Bits 6–4: SEC_H[2:0]

Bits 3–0: SEC_L[3:0]

The second counter value can be set or read through these bits.

The SEC_H[2:0] bits are the BCD code (0–5) of the 10-second digit and the SEC_L[3:0] bits are the BCD code (0–9) of the 1-second digit. Writing second data to this address resets the 1/1024-second counter and clears Registers SUBSEC_L and SUBSEC_H to 0.

0x01:MIN(Minute Data) [BCD mode]

Bit No.	bit7	bit6	bit5	bit4	bit3	bit2	bit1	bit0
Bit Name	○	MIN_H[2:0]			MIN_L[3:0]			
Initial value	0	0	0	0	0	0	0	0
R/W	R	R/W	R/W	R/W	R/W	R/W	R/W	R/W

MIN Valid value: 0x00~0x09, 0x10~0x19, 0x20~0x29, 0x30~0x39, 0x40~0x49, 0x50~0x59;

Bits 6–4: MIN_H[2:0]

Bits 3–0: MIN_L[3:0]

The minute counter value can be set or read through these bits.

The MIN_H[2:0] bits are the BCD code (0–5) of the 10-minute digit and the MIN_L[3:0] bits are the BCD code (0–9) of the 1-minute digit.

0x02: HOUR(Hour Data) [BCD mode]

Bit No.	bit7	bit6	bit5	bit4	bit3	bit2	bit1	bit0
Bit Name	○	○	HOUR_H[1:0]		HOUR_L[3:0]			
Initial value	0	0	0	0	0	0	0	0
R/W	R	R	R/W	R/W	R/W	R/W	R/W	R/W

HOUR Valid value: 0x00~0x09, 0x10~0x19, 0x20~0x23;

Bits 5–4: HOUR_H[1:0]

Bits 3–0: HOUR_L[3:0]

The hour counter value can be set or read through these bits.

The HOUR_H[1:0] bits are the BCD code (0–2) of the 10-hour digit and the HOUR_L[3:0] bits are the BCD code (0–9) of the 1-hour digit.

0x03: WEEKDAY(Day-of-Week Data) [BCD mode]

Bit No.	bit7	bit6	bit5	bit4	bit3	bit2	bit1	bit0
Bit Name	○	WEEK[6:0]						
Initial value	0	1	0	0	0	0	0	0
R/W	R	R/W	R/W	R/W	R/W	R/W	R/W	R/W

WEEKDAY Valid value: 0x01, 0x02, 0x04, 0x08, 0x10, 0x20, 0x40;

Bits 6–0: WEEK[6:0]

The day-of-week counter value can be set or read through these bits.

Each WEEK[6:0] bit one-to-one corresponds to a day of the week as the setting example shown below. Therefore, only one bit corresponding to today must be set. The WEEK[6:0] bits are shifted one bit to the left at the same time the day counter is updated (bit 6 is shifted to bit 0).

Example of day of week setting

WEEK6	WEEK5	WEEK4	WEEK3	WEEK2	WEEK1	WEEK0
Staurday (0x40)	Friday (0x20)	Thursday (0x10)	Wednesday (0x08)	Thursday (0x04)	Monday (0x02)	Sunday (0x01)

0x04: DAY(Day Data) [BCD mode]

Bit No.	bit7	bit6	bit5	bit4	bit3	bit2	bit1	bit0
Bit Name	○	○	DAY_H[1:0]		DAY_L[3:0]			
Initial value	0	0	0	0	0	0	0	1
R/W	R	R	R/W	R/W	R/W	R/W	R/W	R/W

DAY Valid value:

Year	Month	Valid value
Common Year	1/3/5/7/8/10/12	0x00~0x09, 0x10~0x19, 0x20~0x29, 0x30, 0x31
	4/6/8/11	0x00~0x09, 0x10~0x19, 0x20~0x29, 0x30
	2	0x00~0x09, 0x10~0x19, 0x20~0x28
Leap Year	2	0x00~0x09, 0x10~0x19, 0x20~0x29

Bits 5–4: DAY_H[1:0]

Bits 3–0: DAY_L[3:0]

The day counter value can be set or read through these bits.

The DAY_H[1:0] bits are the BCD code (0–3) of the 10-day digit and the DAY_L[3:0] bits are the BCD code (0–9) of the 1-day digit.

0x05: MONTH(Month Data) [BCD mode]

Bit No.	bit7	bit6	bit5	bit4	bit3	bit2	bit1	bit0
Bit Name	○	○	○	MONTH_H	MONTH_L[3:0]			
Initial value	0	0	0	0	0	0	0	1
R/W	R	R	R	R/W	R/W	R/W	R/W	R/W

MONTH Valid value: 0x00~0x09, 0x10~0x11;

Bit 4: MONTH_H

Bits 3–0: MONTH_L[3:0]

The month counter value can be set or read through these bits.

The MONTH_H bits are the BCD code (0–1) of the 10-month digit and the MONTH_L[3:0] bits are the BCD code (0–9) of the 1-month digit.

0x06: YEAR(Year Data) [BCD mode]

Bit No.	bit7	bit6	bit5	bit4	bit3	bit2	bit1	bit0
Bit Name	YEAR_H[3:0]				YEAR_L[3:0]			
Initial value	0	0	0	0	0	0	0	0
R/W	R/W	R/W	R/W	R/W	R/W	R/W	R/W	R/W

YEAR Valid: 0x00~0x09, 0x10~0x19, 0x20~0x29, 0x30~0x39, 0x40~0x49, 0x50~0x59, 0x60~0x69, 0x70~0x79, 0x80~0x89, 0x90~0x99;

Bits 7–4: YEAR_H[3:0]

Bits 3–0: YEAR_L[3:0]

The year counter value can be set or read through these bits.

The YEAR_H[3:0] bits are the BCD code (0–9) of the 10-year digit and the YEAR_L[3:0] bits are the BCD code (0–9) of the 1-year digit.

0x07: ALM_MINUTE(Minute Alarm) [BCD mode]

Bit No.	bit7	bit6	bit5	bit4	bit3	bit2	bit1	bit0
Bit Name	XMAE	MALM_H[2:0]			MALM_L[3:0]			
Initial value	1	0	0	0	0	0	0	0
R/W	R/W	R/W	R/W	R/W	R/W	R/W	R/W	R/W

Bit 7: XMAE

This bit enables/disables the minute alarm setting.

1 (R/W): Minute alarm is disabled.

0 (R/W): Minute alarm is enabled.

When this bit is set to 1, the setting in this register is disabled and it does not affect alarm generation. When this bit is set to 0, the setting in this register is enabled and coincidence between the minute counter value and the setting value of the MALM_H[2:0] and MALM_L[3:0] bits is included in the alarm generation condition.

Bits 6–4: MALM_H[2:0]

Bits 3–0: MALM_L[3:0]

These bits set the minute alarm condition in a BCD code.

The MALM_H[2:0] bits specify the 10-minute digit (0–5) and the MALM_L[3:0] bits specify 1-minute digit (0–9).

0x08: ALM_HOUR(Hour Alarm) [BCD mode]

Bit No.	bit7	bit6	bit5	bit4	bit3	bit2	bit1	bit0
Bit Name	XHAE	(GP)	HALM_H[1:0]		HALM_L[3:0]			
Initial value	1	0	0	0	0	0	0	0
R/W	R/W	R/W	R/W	R/W	R/W	R/W	R/W	R/W

Bit 7: XHAE

This bit enables/disables the hour alarm setting.

1 (R/W): Hour alarm is disabled.

0 (R/W): Hour alarm is enabled.

When this bit is set to 1, the setting in this register is disabled and it does not affect alarm generation. When this bit is set to 0, the setting in this register is enabled and coincidence between the hour counter value and the setting value of the HALM_H[1:0] and HALM_L[3:0] bits is included in the alarm generation condition.

Bits 5–4: HALM_H[1:0]

Bits 3–0: HALM_L[3:0]

These bits set the hour alarm condition in a BCD code.

The HALM_H[1:0] bits specify the 10-hour digit (0–2) and the HALM_L[3:0] bits specify 1-hour digit (0–9).

0x09: ALM_WEEKDAY (Day-of-Week Alarm / Day Alarm) [BCD mode]

Day-of-Week Alarm

Bit No.	bit7	bit6	bit5	bit4	bit3	bit2	bit1	bit0
Bit Name	XWAE	WKALM[6:0]						
Initial value	1	0	0	0	0	0	0	0
R/W	R/W	R/W	R/W	R/W	R/W	R/W	R/W	R/W

Day Alarm

Bit No.	bit7	bit6	bit5	bit4	bit3	bit2	bit1	bit0
Bit Name	XWAE	(GP)	DALM_H[1:0]		DALM_L[3:0]			
Initial value	1	0	0	0	0	0	0	0
R/W	R/W	R/W	R/W	R/W	R/W	R/W	R/W	R/W

Note:

This register switches its function according to the TCTL.WADA bit setting.

TCTL.WADA bit = 0: Day-of-Week Alarm

TCTL.WADA bit = 1: Day Alarm

Bit 7: XWAE

This bit enables/disables the day-of-week or day alarm setting.

1 (R/W): Day-of-week/day alarm is disabled.

0 (R/W): Day-of-week/day alarm is enabled.

When this bit is set to 1, the setting in this register is disabled and it does not affect alarm generation. When this bit is set to 0, the setting in this register is enabled and an alarm will be generated if the following condition is met.

TCTL.WADA bit = 0: The same bit in the day-of-week counter as one that has been set within WKALM[6:0] is set.

TCTL.WADA bit = 1: The day counter value matches with the DALM_H[1:0]/DALM_L[3:0] bit setting value. Bits 6–0: WKALM[6:0] (Day-of-Week Alarm)

These bits set the day-of-week alarm condition.

More than one bit can be set to specify two or more days of the week.

Bits 5–4: DALM_H[1:0] (Day Alarm)

Bits 3–0: DALM_L[3:0] (Day Alarm)

These bits set the day alarm condition in a BCD code.

The DALM_H[1:0] bits specify the 10-day digit (0–3) and the DALM_L[3:0] bits specify 1-day digit (0–9).

0x0A: WTCNT_L (Wakeup Timer Counter Low)

0x0B: WTCNT_M (Wakeup Timer Counter Middle)

0x0C: WTCNT_H (Wakeup Timer Counter High)

Wakeup Timer Counter Low

Bit No.	bit7	bit6	bit5	bit4	bit3	bit2	bit1	bit0
Bit Name	WTCNT[7:0]							
Initial value	0	0	0	0	0	0	0	1
R/W	R/W	R/W	R/W	R/W	R/W	R/W	R/W	R/W

Wakeup Timer Counter Middle

Bit No.	bit7	bit6	bit5	bit4	bit3	bit2	bit1	bit0
Bit Name	WTCNT[15:8]							
Initial value	0	0	0	0	0	0	0	0
R/W	R/W	R/W	R/W	R/W	R/W	R/W	R/W	R/W

Wakeup Timer Counter High

Bit No.	bit7	bit6	bit5	bit4	bit3	bit2	bit1	bit0
Bit Name	WTCNT[23:16]							
Initial value	0	0	0	0	0	0	0	0

R/W	R/W	R/W	R/W	R/W	R/W	R/W	R/W	R/W
-----	-----	-----	-----	-----	-----	-----	-----	-----

Bits 7–0: WTCNT[7:0] (Wakeup Timer Counter Low)

WTCNT[15:8] (Wakeup Timer Counter Middle)

WTCNT[23:16] (Wakeup Timer Counter High)

Notes:

- Make sure the TCTL.TE bit = 0 (wakeup timer disabled) before setting a preset value.
- The preset data cannot be set to 0x000000. If 0x000000 is written to Registers WTCNT_L, WTCNT_M, and WTCNT_H, the wakeup timer cannot perform counting up/down and an interrupt does not occur.

When reading

When the TCTL.TE bit = 1 (wakeup timer enabled), the current counter value is read out from these registers. This counter has a read buffer function, so the correct value can be obtained in any time by reading these three registers successively even if the wakeup timer is operating. When the TCTL.TE bit = 0 (wakeup timer disabled), the currently set preset value is read out.

0x0D: TCTL (Timer Control)

Bit No.	bit7	bit6	bit5	bit4	bit3	bit2	bit1	bit0
Bit Name	FSEL[1:0]		USEL0	TE	WADA	○	TSEL[1:0]	
Initial value	0	0	0	0	0	0	1	0
R/W	R/W	R/W	R/W	R/W	R/W	R/W	R/W	R/W

Bits 7–6: FSEL[1:0]

These bits select an FOUT frequency.

FOUT Output Clock Selections

TCTL.FSEL[1:0]	Output clock
0b00	32.867kHz(default)
0b01	1024Hz
0b10	1Hz
0b11	Off

Bit 5: USEL0

This bit selects a time update interrupt event by using in conjunction with the UPDISEL.USEL1 bit.

Time Update Interrupt Event Selections

UPDISEL.USEL1	TCTL.USEL0	Interrupt event
0	0	Second counter update (default)

0	1	Minute counter update
1	0	Hour counter update
1	1	No interrupt event

Bit 4: TE

This bit enables/disables wakeup timer interrupts.

1 (R/W): Wakeup timer interrupts are enabled.

0 (R/W): Wakeup timer interrupts are disabled.

Bit 3: WADA

This bit selects either day-of-week alarm or day alarm to be used as an alarm generation condition.

1 (R/W): Day alarm

0 (R/W): Day-of-week alarm

Bits 1–0: TSEL[1:0]

These bits select an internal clock used as the source clock of the wakeup timer.

Wakeup Timer Source Clock Selections

WTICFG.TSEL2	TCTL.TSEL[1:0]	Source clock
0	0b00	1024Hz
0	0b01	64Hz
0	0b10	1Hz(default)
0	0b11	1/60Hz
1	0b'xx	External clock input of EVIN2 pin

This setting is effective when the WTICFG.TSEL2 bit = 0. When the WTICFG.TSEL2 bit = 1, the external clock input to the EVIN2 pin is used as the source clock.

0x0E: INTF (Status Flag)

Bit No.	bit7	bit6	bit5	bit4	bit3	bit2	bit1	bit0
Bit Name	PORF	OSCSTPF	UF	TF	AF	EVF	VLF	VTMPLF
Initial value	1	1	0	0	0	0	1	1
R/W	R/W	R/W	R/W	R/W	R/W	R/W	R/W	R/W

Bit 7: PORF

This is a self-monitoring flag that indicates whether a power-on-reset is executed after power is turned on or not.

1 (R): Power-on-reset has been detected.

0 (R): No power-on-reset has been detected.

1 (W): Ineffective

0 (W): Flag clear (effective only when power-on reset has been cancelled)

Bit 6: OSCSTPF

OSCSTPF This is a self-monitoring flag that indicates whether the oscillation of the crystal oscillator has stopped or not.

1 (R): Oscillation stop state has been detected.

0 (R): Oscillator stop state has not been detected.

1 (W): Ineffective

0 (W): Flag clear (effective only when an oscillation stop state has not been detected)

Bit 5: UF**Bit 4: TF****Bit 3: AF****Bit 2: EVF**

They are interrupt flags that indicate occurrence of an RTC interrupt event.

1 (R): Interrupt event has occurred.

0 (R): No interrupt event has occurred.

1 (W): Ineffective

0 (W): Flag clear (except for EVF)

The following shows the correspondence between the bit and interrupt:

UF: Time update interrupt

TF: Wakeup timer interrupt

AF: Alarm interrupt

EVF: Time stamp event detection interrupt

Bit 1: VLF

This is a self-monitoring flag that indicates an abnormality.

1 (R): There is an abnormality. (PORF bit = 1 or OSCSTPF bit = 1)

0 (R): No abnormality

1 (W): Ineffective

0 (W): Flag clear (effective only when power-on reset has been cancelled and an oscillation stop state has not been detected)

Bit 0: VTMLPF

This is a self-monitoring flag that indicates the history of a VDD voltage drop to the temperature compensation update stop voltage or less ($VDD \leq V_{TEMP}$).

1 (R): Voltage drop has been detected.

0 (R): Voltage drop has not been detected.

1 (W): Ineffective

0 (W): Flag clear (effective only when the VDD voltage is normal)

0x0F: TSTP_INTE (Timer Stop and Interrupt Enable)

Bit No.	bit7	bit6	bit5	bit4	bit3	bit2	bit1	bit0
Bit Name	CSEL[1:0]		UIE	TIE	AIE	EIE	○	STOP
Initial value	0	1	0	0	0	0	0	0
R/W	R/W	R/W	R/W	R/W	R/W	R/W	R/W	R/W

Bits 7–6: CSEL[1:0]

These bits set the execution interval of the temperature sensor measurement operation.

Execution Interval of Temperature Sensor Measurement Operation

TSTP_INTE.CSEL[1:0]	Execution interval
0b00	0.5 seconds
0b01	2.0 seconds(default)
0b10	10.0 seconds
0b11	30.0 seconds

Bit 5: UIE

Bit 4: TIE

Bit 3: AIE

Bit 2: EIE

These bits enable the interrupts output to /INT pin.

1 (R/W): Interrupts output to /INT pin are enabled.

0 (R/W): Interrupts output to /INT pin are disabled.

Each bit corresponds to an interrupt as shown below.

UIE: Time update interrupt

TIE: Wakeup timer interrupt

AIE: Alarm interrupt

EIE: Time stamp event detection interrupt

Bit 0: STOP

This bit controls the timer counter operations.

1 (W): Stops operating of the counters.

0 (W): Starts operating of the counters.

1 (R): The timer is idle.

0 (R): The timer is operating.

The STOP bit stops the following operations:

1) Stop sub_sec(1/1024), second, minute, day, day of week, month, and year counters, and binary second counter. Thus, a time update interrupt and an alarm interrupt do not occur. The time stamp function uses the time at the point the counters stop as the clock data.

2) Wakeup timer interrupt: The wakeup timer stops and does not generate an interrupt.

3) FOUT output: The FOUT output fixed at H or L when 1 Hz output is selected. When 32.768 kHz or 1024 Hz is selected, the output continues even if the STOP bit = 1.

Note:

If the timer is stopped by the STOP bit when reading clock/calendar data, time error is increased. Therefore, do not stop the counter using the STOP bit when reading the clock/calendar registers.

0x10: SUBSEC_L (Sub-Second Data Low)

0x11: SUBSEC_H (Sub-Second Data High)

Sub-Second Data Low

Bit No.	bit7	bit6	bit5	bit4	bit3	bit2	bit1	bit0
Bit Name	SUBSEC[1:0]		○	○	○	○	○	○
Initial value	0	0	0	0	0	0	0	0
R/W	R/W	R/W	R	R	R	R	R	R

Sub-Second Data High

Bit No.	bit7	bit6	bit5	bit4	bit3	bit2	bit1	bit0
Bit Name	SUBSEC[9:2]							
Initial value	0	0	0	0	0	0	0	0
R/W	R/W	R/W	R/W	R/W	R/W	R/W	R/W	R/W

SUB-SECOND Valid value: 0x00 0000 0000 ~ 0xFF FFFF FFFF;

Bits 7–6: SUBSEC[1:0] (Sub-Second Data Low)

Bits 7–0: SUBSEC[9:2] (Sub-Second Data High)

These bits are used to set and read the 1/1024-second counter, which is a 10-bit binary counter. The SUBSEC_L.SUBSEC[1:0] bits are the low-order 2 bits of the 1/1024-second counter and the SUBSEC_H.

SUBSEC[9:2] bits are the high-order 8 bits.

SUBSEC[9:0] bits

Bit	SUBSEC9	SUBSEC8	SUBSEC7	SUBSEC6	SUBSEC5	SUBSEC4	SUBSEC3	SUBSEC2	SUBSEC1	SUBSEC0
Count value (1024Hz) cycle	512	256	128	64	32	16	8	4	2	1

Writing data to Register SEC (Address 0x00, BCD mode) resets the 1/1024-second counter, as a result, Registers SUBSEC_L and SUBSEC_H are cleared to 0. On the other hand, writing data to Register SEC_MIR (Address 0x12), which is the mirror address of Register SEC, does not reset the 1/1024-second counter.

0x12: SEC_MIR (Mirrored Second Data, = 0x00) [BCD mode]

Bit No.	bit7	bit6	bit5	bit4	bit3	bit2	bit1	bit0
Bit Name	○	SEC_H[2:0]			SEC_L[3:0]			
Initial value	0	0	0	0	0	0	0	0
R/W	R	R/W	R/W	R/W	R/W	R/W	R/W	R/W

This is a mirror register of Register SEC. For more information, refer to “0x00: SEC (Second Data).” However, writing to this address does not reset the 1/1024-second counter.

0x13: MIN_MIR (Mirrored Minute Data, = 0x0h) [BCD mode]

Bit No.	bit7	bit6	bit5	bit4	bit3	bit2	bit1	bit0
Bit Name	○	MIN_H[2:0]			MIN_L[3:0]			
Initial value	0	0	0	0	0	0	0	0
R/W	R	R/W	R/W	R/W	R/W	R/W	R/W	R/W

This is a mirror register of Register MIN. For more information, refer to “0x01: MIN (Minute Data).”

0x14: HOUR_MIR (Mirrored Hour Data, = 0x02) [BCD mode]

Bit No.	bit7	bit6	bit5	bit4	bit3	bit2	bit1	bit0
Bit Name	○	○	HOUR_H[1:0]		HOUR_L[3:0]			
Initial value	0	0	0	0	0	0	0	0
R/W	R	R	R/W	R/W	R/W	R/W	R/W	R/W

This is a mirror register of Register HOUR. For more information, refer to “0x02: HOUR (Hour Data).”

0x15: WEEKDAY_MIR (Mirrored Day-of-Week Data, = 0x03) [BCD mode]

Bit No.	bit7	bit6	bit5	bit4	bit3	bit2	bit1	bit0
---------	------	------	------	------	------	------	------	------

Bit Name	○	WEEK[6:0]						
Initial value	0	1	0	0	0	0	0	0
R/W	R	R	R/W	R/W	R/W	R/W	R/W	R/W

This is a mirror register of Register WEEKDAY. For more information, refer to “0x03: WEEKDAY (Day-of Week Data).”

0x16: DAY_MIR (Mirrored Day Data, = 0x04) [BCD mode]

Bit No.	bit7	bit6	bit5	bit4	bit3	bit2	bit1	bit0
Bit Name	○	○	DAY_H[1:0]		DAY_L[3:0]			
Initial value	0	0	0	0	0	0	0	1
R/W	R	R	R/W	R/W	R/W	R/W	R/W	R/W

This is a mirror register of Register DAY. For more information, refer to “0x04: DAY (Day Data).”

0x17: MONTH_MIR (Mirrored Month Data, = 0x05) [BCD mode]

Bit No.	bit7	bit6	bit5	bit4	bit3	bit2	bit1	bit0
Bit Name	○	○	○	MONTH_H	MONTH_L[3:0]			
Initial value	0	0	0	0	0	0	0	1
R/W	R	R	R	R/W	R/W	R/W	R/W	R/W

This is a mirror register of Register MONTH. For more information, refer to “0x05: MONTH (Month Data).”

0x18: YEAR_MIR (Mirrored Year Data, = 0x06) [BCD mode]

Bit No.	bit7	bit6	bit5	bit4	bit3	bit2	bit1	bit0
Bit Name	YEAR_H[3:0]				YEAR_L[3:0]			
Initial value	0	0	0	0	0	0	0	0
R/W	R/W	R/W	R/W	R/W	R/W	R/W	R/W	R/W

This is a mirror register of Register YEAR. For more information, refer to “0x06: YEAR (Year Data).”

0x00 / 0x12: SEC_BIN0 (Second Binary Data 0) [BIN mode]

0x01 / 0x13: SEC_BIN1 (Second Binary Data 1) [BIN mode]

0x02 / 0x14: SEC_BIN2 (Second Binary Data 2) [BIN mode]

0x03 / 0x15: SEC_BIN3 (Second Binary Data 3) [BIN mode]

0x04 / 0x16: SEC_BIN4 (Second Binary Data 4) [BIN mode]

Second Binary Data 0

Bit No.	bit7	bit6	bit5	bit4	bit3	bit2	bit1	bit0
---------	------	------	------	------	------	------	------	------

Bit Name	SEC_BIN[7:0]							
Initial value	0	0	0	0	0	0	0	0
R/W	R/W	R/W	R/W	R/W	R/W	R/W	R/W	R/W

Second Binary Data 1

Bit No.	bit7	bit6	bit5	bit4	bit3	bit2	bit1	bit0
Bit Name	SEC_BIN[15:8]							
Initial value	0	0	0	0	0	0	0	0
R/W	R/W	R/W	R/W	R/W	R/W	R/W	R/W	R/W

Second Binary Data 2

Bit No.	bit7	bit6	bit5	bit4	bit3	bit2	bit1	bit0
Bit Name	SEC_BIN[23:16]							
Initial value	0	0	0	0	0	0	0	0
R/W	R/W	R/W	R/W	R/W	R/W	R/W	R/W	R/W

Second Binary Data 3

Bit No.	bit7	bit6	bit5	bit4	bit3	bit2	bit1	bit0
Bit Name	SEC_BIN[31:24]							
Initial value	0	0	0	0	0	0	0	0
R/W	R/W	R/W	R/W	R/W	R/W	R/W	R/W	R/W

Second Binary Data 4

Bit No.	bit7	bit6	bit5	bit4	bit3	bit2	bit1	bit0
Bit Name	○	○	○	○	○	○	○	SEC_BIN[32]
Initial value	0	0	0	0	0	0	0	0
R/W	R	R	R	R	R	R	R	R/W

Bits 7–0: SEC_BIN[7:0] (Second Binary Data 0) , Valid value: 0x00 ~ 0xFF;

SEC_BIN[15:8] (Second Binary Data 1) , Valid value: 0x00 ~ 0xFF;

SEC_BIN[23:16] (Second Binary Data 2) , Valid value: 0x00 ~ 0xFF;

SEC_BIN[31:24] (Second Binary Data 3) , Valid value: 0x00 ~ 0xFF;

Bit 0: SEC_BIN[32] (Second Binary Data 4) , Valid value: 0x0 ~ 0x1;

The BIN counter value can be set or read through these bits. Writing second data to these registers does not clear Registers SUBSEC_L and SUBSEC_H to 0. These registers can be accessed when Register CNTSEL = 0x3 or 0x2.

0x19: OFS_SUBSEC_H (Offset Sub-Second Data High)

0x1A: OFS_SUBSEC_L (Offset Sub-Second Data Low)

Offset Sub-Second Data High

Bit No.	bit7	bit6	bit5	bit4	bit3	bit2	bit1	bit0
Bit Name	OFS_SUBSEC[10]	(GP)	(GP)	OFS_SUBSEC[9:5]				
Initial value	0	0	0	0	0	0	0	0
R/W	R/W	R/W	R/W	R/W	R/W	R/W	R/W	R/W

Offset Sub-Second Data Low

Bit No.	bit7	bit6	bit5	bit4	bit3	bit2	bit1	bit0
Bit Name	OFS_SUBSEC[4:0]					○	OFSIN	OFSIN
Initial value	0	0	0	0	0	0	1	0
R/W	R/W	R/W	R/W	R/W	R/W	R	R	R/W

Bit 7: OFS_SUBSEC[10] (Offset Sub-Second Data High)

Bits 4–0: OFS_SUBSEC[9:5] (Offset Sub-Second Data High)

Bits 7–3: OFS_SUBSEC[4:0] (Offset Sub-Second Data Low)

These bits are used to set the offset value for adjusting 1/1024-second time. To directly add the offset value to the 1/1024-second counter, it must be calculated as a 2's complement value with 11-bit data length and set the Bit 10 to the OFS_SUBSEC [10] bit and Bits 9 to 0 to the OFS_SUBSEC[9:0] bits.

Bit 1 OFSFIN (Offset Sub-Second Data Low)

This bit indicates the operation status of the 1/1024-second offset correction.

1 (R): Offset correction has completed. Ready for offset correction.

0 (R): Offset correction is in progress.

Bit 0 OFSEN (Offset Sub-Second Data Low)

This bit starts a 1/1024-second offset correction.

1 (W): Start offset correction

0 (W): Ineffective

The offset value will be reflected to the 1/1024-second counter when the second counter is updated immediately

0x1B: DIG_TRIM_H (Digital Trimming Data High)

0x1C: DIG_TRIM_L (Digital Trimming Data Low)

Digital Trimming Data High

Bit No.	bit7	bit6	bit5	bit4	bit3	bit2	bit1	bit0
Bit Name	DTRIM[8:1]							
Initial value	0	0	0	0	0	0	0	0
R/W	R/W	R/W	R/W	R/W	R/W	R/W	R/W	R/W

Digital Trimming Data Low

Bit No.	bit7	bit6	bit5	bit4	bit3	bit2	bit1	bit0
---------	------	------	------	------	------	------	------	------

Bit Name	DTRIM[0]	○	○	○	○	○	○	DTRIMEN
Initial value	0	0	0	0	0	0	0	0
R/W	R/W	R	R	R	R	R	R	R/W

Bits 7–0: DTRIM[8:1] (Digital Trimming Data High)

Bit 7: DTRIM[0] (Digital Trimming Data Low)

Bit 0: DTRIMEN :

1 (R/W): Theoretical regulation function is enabled.

0 (R/W): Theoretical regulation function is disabled.

DTRIM[8:0] Setting Value (1 uint = 0.954ppm)	Theoretical regulation result
0x0FF=+255	+243.186ppm
0x0FE=+254	+242.232ppm
...	
0x003=+3	2.861ppm
0x002=+2	1.907ppm
0x001=+1	0.954ppm
0x000=0	0ppm
0x1FF=-1	-0.954ppm
0x1FE=-2	-1.907ppm
0x1FD=-3	-2.861ppm
...	
0x102	-242.232ppm
0x101	-243.186ppm
0x100	Setting prohibited

0x1D: TCTL_MIR (Mirrored Timer Control, = 0x0D)

Bit No.	bit7	bit6	bit5	bit4	bit3	bit2	bit1	bit0
Bit Name	FSEL[1:0]		USEL0	TE	WADA	○	TSEL[1:0]	
Initial value	0	0	0	0	0	0	1	0
R/W	R/W	R/W	R/W	R/W	R/W	R	R/W	R/W

This is a mirror register of Register TCTL. For more information, refer to “0x0D: TCTL (Timer Control).”

0x1E: INTF_MIR (Mirrored Status Flag, = 0x0E)

Bit No.	bit7	bit6	bit5	bit4	bit3	bit2	bit1	bit0
Bit Name	PORF	OSCSTPF	UF	TF	AF	EVF	VLF	VTMPLF
Initial value	1	1	0	0	0	0	1	1
R/W	R/W	R/W	R/W	R/W	R/W	R/W	R/W	R/W

This is a mirror register of Register INTF. For more information, refer to “0x0E: INTF (Status Flag).”

0x1F: CNTSEL (Counter Select)

Bit No.	bit7	bit6	bit5	bit4	bit3	bit2	bit1	bit0
Bit Name	○	○	○	○	○	ACCBCD	BINCNTEN	BCDCNTEN
Initial value	0	0	0	0	0	1	1	1
R/W	R	R	R	R	R	R/W	R/W	R/W

Bit 2: ACCBCD

This bit selects a clock/calendar counter access mode (selects whether to access the BCD counters [Registers SEC to YEAR] or BIN counter [Registers SEC_BINn]).

1 (R/W): BCD mode (to read/write the BCD counters)

0 (R/W): BIN mode (to read/write the BIN counter)

Bit 1: BINCNTEN

This bit enables/disables the BIN counter to operate.

1 (R/W): BIN counter is enabled.

0 (R/W): BIN counter is disabled.

Bit 0: BCDCNTEN

This bit enables/disables the BCD counters to operate.

1 (R/W): BCD counters are enabled.

0 (R/W): BCD counters are disabled.

0x20: EVIN_EN (Event Input Enable)

Bit No.	bit7	bit6	bit5	bit4	bit3	bit2	bit1	bit0
Bit Name	○	○	○	EVIN2CPEN	EVIN1CPEN	○	EVIN1EN	EVIN1EN
Initial value	0	0	0	0	0	0	0	0
R/W	R	R	R	R/W	R/W	R	R/W	R/W

Bit 4 EVIN2CPEN

Bit 3 EVIN1CPEN

These bits enable/disable external event trigger inputs from the EVINn pin to capture time stamp data to the buffer.

1 (R/W): EVINn is enabled to capture time stamp data.

0 (R/W): EVINn is disabled to capture time stamp data.

The EVINnCPEN bit setting is effective when the EVINnEN bit (described below) = 1.

Bit 1 EVIN2EN

Bit 0 EVIN1EN

These bits enable/disable the EVINn pin to input external event triggers.

1 (R/W): EVINn is enabled to input event triggers.

0 (R/W): EVINn is disabled to input event triggers.

0x21: EVIN1_CFG (EVIN1 Configuration)

0x23: EVIN2_CFG (EVIN2 Configuration)

Bit No.	bit7	bit6	bit5	bit4	bit3	bit2	bit1	bit0
Bit Name	○	○	○	PUPD[2:0]			POL[1:0]	
Initial value	0	0	0	0	1	0	0	0
R/W	R	R	R	R/W	R/W	R/W	R/W	R/W

Bits 4–2: PUPD[2:0]

These bits select an internal pull-up or pull-down resistor to be connected to the EVINn pin.

EVINn Pin Pull-Up/Pull-Down Resistor Selections

EVINn_CFG.PUPD[2:0]	Pull-up/down resistor
0b000	No pull-up/pull-down resistor
0b001	Pull-up resistor 500 kΩ
0b010	Pull-up resistor 1 MΩ (default)
0b011	
0b100	Pull-down resistor 500 kΩ
Other	No pull-up/pull-down resistor

Bits 1–0: POL[1:0]

These bits select the EVINn input signal detection edge polarity that captures time stamp data.

Selecting EVINn Input Signal Detection Edge Polarity

EVINn_CFG.POL[1:0]	Pull-up/down resistor
--------------------	-----------------------

0b00	Falling edge (default)
0b01	Rising edge
0b10	Falling and Rising edge
0b11	

0x22: EVIN1_FLT (EVIN1 Noise Filter)

0x24: EVIN2_FLT (EVIN2 Noise Filter)

Bit No.	bit7	bit6	bit5	bit4	bit3	bit2	bit1	bit0
Bit Name	○	○	FLT[5:0]					
Initial value	0	0	0	0	0	0	0	0
R/W	R	R	R/W	R/W	R/W	R/W	R/W	R/W

Bits 5–0: FLT[5:0]

These bits set the noise filtering time for the EVINn input signals.

Noise Filtering Time for EVINn Input

EVINn_FLT.FLT[5:0]	Uncertain EVINn pulse width (Whether the edge input is detected or not depends on the relationship between the edge input timing and the sampling timing in 125 ms cycles.)	Valid EVINn pulse width (The edge input is always detected.)
0x00	○	1 ms or more
0x01 (Setting prohibited)	○	○
0x02	125 ms or more and less than 250 ms	250 ms or more
0x03	125 ms or more and less than 250 ms	375 ms or more
:	:	:
0x27	125 ms or more and less than 250 ms	4875 ms or more
0x28	125 ms or more and less than 250 ms	5000 ms or more
0x29 or more (Setting prohibited)	○	○

0x27: BUF1_CFG1 (BUF1 Configuration 1)

Bit No.	bit7	bit6	bit5	bit4	bit3	bit2	bit1	bit0
Bit Name	BINSEL	OVWEN	○	○	○	FULLIEN	EMPTIEN	OVWIEN
Initial value	0	0	0	0	0	0	0	0
R/W	R/W	R/W	R	R	R	R/W	R/W	R/W

Bit 7: BINSEL

This bit selects either the BCD counter or the BIN counter to capture date and time data to be recorded to the buffer when an event occurs.

1 (R/W): BIN counter data is captured.

0 (R/W): BCD counter data is captured.

Bit 6: OVWEN

This bit sets the write mode after the buffer becomes full (after captured data is written to Bank 7).

1 (R/W): Overwrite mode (Bank 7 is overwritten.)

0 (R/W): Overwrite Inhibit mode (recording stops in buffer full state, captured data are discarded.)

Bit 2: FULLIEN

This bit enables/disables buffer full interrupts.

1 (R/W): Buffer full interrupts are enabled.

0 (R/W): Buffer full interrupts are disabled.

When this bit is set to 1, the interrupt flag (BUF1_STAT.FULLF bit) will be set to 1 if a buffer full status occurs.

Bit 1: EMPTIEN

This bit enables/disables buffer not empty interrupts.

1 (R/W): Buffer not empty interrupts are enabled.

0 (R/W): Buffer not empty interrupts are disabled.

When this bit is set to 1, the interrupt flag (BUF1_STAT.EMPTF bit) will be set to 1 if time stamp data is written to the buffer in empty status.

Bit 0: OVWIEN This bit enables/disables buffer overwrite interrupts.

1 (R/W): Buffer overwrite interrupts are enabled.

0 (R/W): Buffer overwrite interrupts are disabled.

When this bit is set to 1, the interrupt flag (BUF1_STAT.OVWF bit) will be set to 1 if a time stamp is captured while the buffer is in full status.

0x28: BUF1_STAT (BUF1 Status)

Bit No.	bit7	bit6	bit5	bit4	bit3	bit2	bit1	bit0
Bit Name	FULLF	EMPTF	○	○	○	○	○	OVWF
Initial value	0	1	0	0	0	0	0	0
R/W	R/W	R/W	R	R	R	R	R	R/W

Bit 7: FULLF

This flag indicates whether the buffer is in full status or not.

1 (R): Buffer full status

0 (R):Free space available in the buffer

This flag is set to 1 if a newly captured time stamp data is written to the Bank 7 buffer when data has

been written to the Bank 6 buffer only.

Bit 6: EMPTF

This flag indicates whether the buffer is in empty status or not.

1 (R): Buffer empty status

0 (R): Buffer data available

This flag is initially set to 1 and cleared to 0 when the 1st captured time stamp data is written to the Bank 6 buffer.

Bit 0: OVWF

This flag indicates whether a new time stamp data is captured or not while the buffer is in full status. Overwrite Inhibit mode

1 (R): Data has been captured while the buffer is in full status (the latest data was destroyed).

0 (R): Data has not been captured after the buffer becomes full.

Overwrite mode

1 (R): Overwriting has occurred (Bank 7 was overwritten with the latest data).

0 (R): Overwriting has not occurred.

This flag is set to 1 when a new time stamp data is captured while the buffer is in full status.

Note:

The flags in this register cannot be reset by reading the buffer. To reset the flags, it is necessary to issue a command trigger (writing to Register WRCMD_TRG) with the WRCMD_CFG. BUF1FCLREN bit set to 1.

0x29: BUF1_CFG2 (BUF1 Configuration 2)

Bit No.	bit7	bit6	bit5	bit4	bit3	bit2	bit1	bit0
Bit Name	○	SRAMMOD	○	○	○	○	○	○
Initial value	0	0	0	0	0	0	0	0
R/W	R	R/W	R	R	R	R	R	R

Bit 6: SRAMMOD

This bit enables/disables SRAM mode for reading/writing from/to the buffer.

1 (R/W): SRAM mode is enabled.

0 (R/W): SRAM mode is disabled.

0x30: ALM_SEC (Second Alarm)

Bit No.	bit7	bit6	bit5	bit4	bit3	bit2	bit1	bit0
Bit Name	XSAE	SALM_H[2:0]			SALM_L[3:0]			
Initial value	0	0	0	0	0	0	0	0
R/W	R/W	R/W	R/W	R/W	R/W	R/W	R/W	R/W

Bit 7: XSAE

This bit enables/disables the second alarm setting.

1 (R/W): Second alarm is disabled.

0 (R/W): Second alarm is enabled.

Bits 3–0: SALM_L[3:0]

Bits 6-4: SALM_H[2:0]

These bits set the second alarm condition in a BCD code.

The SALM_H[2:0] bits specify the 10-second digit (0–5) and the SALM_L[3:0] bits specify 1-second digit (0 9).

0x31: ALM_MIN_MIR (Mirrored Minute Alarm, = 0x07)

Bit No.	bit7	bit6	bit5	bit4	bit3	bit2	bit1	bit0
Bit Name	XMAE	MALM_H[2:0]			MALM_L[3:0]			
Initial value	1	0	0	0	0	0	0	0
R/W	R/W	R/W	R/W	R/W	R/W	R/W	R/W	R/W

This is a mirror register of Register ALM_MIN. For more information, refer to “0x07: ALM_MIN (Minute Alarm).”

0x32: ALM_HOUR_MIR (Mirrored Hour Alarm, = 0x08)

Bit No.	bit7	bit6	bit5	bit4	bit3	bit2	bit1	bit0
Bit Name	XHAE	(GP)	HALM_H[1:0]		HALM_L[3:0]			
Initial value	1	0	0	0	0	0	0	0
R/W	R/W	R/W	R/W	R/W	R/W	R/W	R/W	R/W

This is a mirror register of Register ALM_HOUR. For more information, refer to “0x08: ALM_HOUR (Hour Alarm).”

0x33: ALM_WEEKDAY_MIR (Mirrored Day-of-Week Alarm / Day Alarm, = 0x09)

Mirrored Day-of-Week Alarm

Bit No.	bit7	bit6	bit5	bit4	bit3	bit2	bit1	bit0
Bit Name	XWAE	WKALM[6:0]						
Initial value	1	0	0	0	0	0	0	0
R/W	R/W	R/W	R/W	R/W	R/W	R/W	R/W	R/W

Mirrored Day Alarm

Bit No.	bit7	bit6	bit5	bit4	bit3	bit2	bit1	bit0
Bit Name	XWAE	(GP)	DALM_H[1:0]		DALM_L[3:0]			
Initial value	1	0	0	0	0	0	0	0
R/W	R/W	R/W	R/W	R/W	R/W	R/W	R/W	R/W

This is a mirror register of Register ALM_WEEKDAY. For more information, refer to “0x09: ALM_WEEKDAY (Day-of-Week Alarm / Day Alarm).”

0x34: UPDISEL (Time Update Interrupt Select)

Bit No.	bit7	bit6	bit5	bit4	bit3	bit2	bit1	bit0
Bit Name	○	○	○	○	○	○	USEL1	○
Initial value	0	0	0	0	0	0	0	0
R/W	R	R	R	R	R	R	R/W	R

Bit 1: USEL1

This bit selects a time update interrupt event by using it together with the TCTL.USEL0 bit

0x38: WTICFG (Wakeup Timer Interrupt Configuration)

Bit No.	bit7	bit6	bit5	bit4	bit3	bit2	bit1	bit0
Bit Name	PINMUX[1:0]		RSTOPT[1:0]		WTNETIM	TSEL2	WTIOUT	UPDOWNMOD
Initial value	0/1	0/1	0	0	0	0	0	0
R/W	R/W	R/W	R/W	R/W	R/W	R/W	R/W	R/W

Bits 7–6: PINMUX[1:0]

Be sure to avoid changing these bits from the initial value, otherwise, unexpected pin functions may be assigned.

WTICFG.PINMUX[1:0] Bit Initial Value of Each Product

Bits 5–4: RSTOPT[1:0]

These bits select whether to disable the inputs/outputs or not while the reset signal (/RST) is being output. When the input pins are disabled, they can be placed into a Hi-Z state. When the output pins are disabled, they go into a Hi-Z state. Disable: Inputs/outputs are disabled while /RST = L (power supply voltage drop is detected). Enable: Inputs/outputs are not disabled while /RST = L (power supply voltage drop is detected). This function is effective only in the models with the /RST pin function.

Selecting Reset Output Option

WTICFG. RSTOPT[1:0]	FOE, CE, CLK, DI (DIO), SCL, SDA pin inputs DO pin output	FOUT, /INT, SOUT pin outputs
0b00	Disabled(default)	Disabled(default)

0b01	Disabled	Enabled
0b10	Enabled	Disabled
0b11	Enabled	Enabled

Bit 3: WTONETIM Enabled

This bit selects whether to automatically negate the /INT output or not after a wakeup timer interrupt occurs.

1 (R/W): Not negated automatically (low output)

0 (R/W): Negated automatically (7.812 ms width low pulse output)

Bit 2: TSEL2

This bit selects an external clock as the wakeup timer source clock.

1 (R/W): External clock input to the EVIN2 pin

0 (R/W): Internal clock selected with the TCTL.TSEL[1:0] bits

Bit 1: WTIOUT

This bit selects the wakeup timer interrupt signal output pin.

1 (R/W): Output from the FOUT pin (CMOS buffer output)

0 (R/W): Output from the /INT pin (Open drain output)

Note:

When using the FOUT pin only for the wakeup timer interrupt signal output, set the TCTL.FSEL[1:0] bits to 0b11 to disable the FOUT output.

Bit 0: UPDOWNMOD

This bit sets the wakeup timer count mode.

1 (R/W): Count-up mode

0 (R/W): Count-down mode

0x39: WTCTL (Wakeup Timer Control)

Bit No.	bit7	bit6	bit5	bit4	bit3	bit2	bit1	bit0
Bit Name	WTRST	EXWTRSTEN	WTRSTWIN[1:0]		WTMODSEL	WTSTOPCTL	○	WTSTOP
Initial value	0/1	0/1	0	0	0	0	0	0
R/W	R/W	R/W	R/W	R/W	R/W	R/W	R	R/W

Bit 7: WTRST

This bit reloads the preset value to the wakeup timer.

1 (W): Timer is preset.

0 (W): Ineffective

Writing 1 to this bit reloads the preset value to the wakeup timer counter in Count-down mode or reloads 1 in Count-up mode, and then restarts the count operation. This makes it possible to use the wakeup timer as a watchdog timer.

This bit is always read as 0 even after writing 1.

Bit 6: EXWTRSTEN

This bit enables/disables resetting the wakeup timer by an external input signal.

1 (W): External input reset is enabled.

0 (W): External input reset is disabled.

When the EXWTRSTEN bit is set to 1, the wakeup timer is reset by inputting a high pulse to the EVIN2 pin. This external input reset can be used in combination with the WTRST bit reset.

Bits 5–4: WTRSTWIN[1:0]

These bits specify the reset acceptance period (reset window) for the wakeup timer set into Count-down mode. This limitation of reset acceptance period is applied to both resets by the WTRST bit and external signal input.

Reset Window Settings

WTCTL. WTRSTWIN[1:0]	Reset acceptance period (Count-down mode)
0b00	Whole period (default)
0b01	Counter value = 2 to 1
0b10	Counter value = 16 to 1
0b11	Counter value = 64 to 1

Bit 3: WTMODSEL

This bit restricts the wakeup timer to operate either in Normal mode (reset output is cancelled) or Safe mode (during reset output).

When WTSTOPCTL is set to 1.

1 (R/W): The timer work on Normal mode.

0 (R/W): The timer work on Safe mode.

When WTSTOPCTL is set to 0, this bit is disabled. Timer work on Normal mode and Safe mode.

Bit 2: WTSTOPCTL

This bit enables/disables the WTMODSEL and WTSTOP bit functions.

1 (R/W): WTMODSEL is enabled and WTSTOP is disabled.

0 (R/W): WTMODSEL is disabled and WTSTOP is enabled.

Bit 0: WTSTOP

This bit temporarily stops the wakeup timer.

1 (R/W): The wakeup timer is stopped.

0 (R/W): The wakeup timer stop state is cancelled (the wakeup timer is operating normally).

0x3A: WTCNT_L_MIR (Mirrored Wakeup Timer Counter Low, = 0x0A)

0x3B: WTCNT_M_MIR (Mirrored Wakeup Timer Counter Middle, = 0x0B)

0x3C: WTCNT_H_MIR (Mirrored Wakeup Timer Counter High, = 0x0C)

Mirrored Wakeup Timer Counter Low

Bit No.	bit7	bit6	bit5	bit4	bit3	bit2	bit1	bit0
Bit Name	WTCNT[7:0]							
Initial value	0	0	0	0	0	0	0	1
R/W	R/W	R/W	R/W	R/W	R/W	R/W	R/W	R/W

Mirrored Wakeup Timer Counter Middle

Bit No.	bit7	bit6	bit5	bit4	bit3	bit2	bit1	bit0
Bit Name	WTCNT[15:8]							
Initial value	0	0	0	0	0	0	0	0
R/W	R/W	R/W	R/W	R/W	R/W	R/W	R/W	R/W

Mirrored Wakeup Timer Counter High

Bit No.	bit7	bit6	bit5	bit4	bit3	bit2	bit1	bit0
Bit Name	WTCNT[23:16]							
Initial value	0	0	0	0	0	0	0	0
R/W	R/W	R/W	R/W	R/W	R/W	R/W	R/W	R/W

These are mirror registers of Registers WTCNT_L, WTCNT_M, and WTCNT_H. For more information, refer to “0x0A–0x0C: WTCNT_L/WTCNT_M/WTCNT_H (Wakeup Timer Counter Low/Middle/High).”

0x3D: TCTL_MIR (Mirrored Timer Control, = 0x0D)

Bit No.	bit7	bit6	bit5	bit4	bit3	bit2	bit1	bit0
Bit Name	FSEL[1:0]		USEL0	TE	WADA	○	TSEL[1:0]	
Initial value	0	0	0	0	0	0	1	0
R/W	R/W	R/W	R/W	R/W	R/W	R/W	R/W	R/W

This is a mirror register of Register TCTL. For more information, refer to “0x0D: TCTL (Timer Control).”

0x3E: INTF_MIR (Mirrored Status Flag, = 0x0E)

Bit No.	bit7	bit6	bit5	bit4	bit3	bit2	bit1	bit0
---------	------	------	------	------	------	------	------	------

Bit Name	PORF	OSCSTPF	UF	TF	AF	EVF	VLF	VTMPLF
Initial value	1	1	0	0	0	0	1	1
R/W	R/W	R/W	R/W	R/W	R/W	R/W	R/W	R/W

This is a mirror register of Register INTF. For more information, refer to “0x0E: INTF (Status Flag).”

0x3F: TSTP_INTE_MIR (Mirrored Timer Stop and Interrupt Enable, = 0x0F)

Bit No.	bit7	bit6	bit5	bit4	bit3	bit2	bit1	bit0
Bit Name	CSEL[1:0]		UIE	TIE	AIE	EIE	○	STOP
Initial value	0	1	0	0	0	0	0	0
R/W	R/W	R/W	R/W	R/W	R/W	R/W	R/W	R/W

This is a mirror register of Register TSTP_INTE. For more information, refer to “0x0F: TSTP_INTE (Timer Stop and Interrupt Enable).”

0x41: WRCMD_CFG (Write Command Configuration)

Bit No.	bit7	bit6	bit5	bit4	bit3	bit2	bit1	bit0
Bit Name	EVCNTCLREN	○	○	BUF1FCLREN	○	○	○	CMDTRGEN
Initial value	0	0	0	0	0	0	0	0
R/W	R/W	R	R	R/W	R	R	R	R/W

Note:

This register specifies the functions that will be executed when any data is written to Register WRCMD_TRG (Address 0x42).

Bit 7: EVCNTCLREN

This bit specifies whether to initialize the event counters or not when a command trigger is executed by writing to Register WRCMD_TRG.

1 (R/W): Event counter is initialized.

0 (R/W): Event counter is not initialized.

Executing a command trigger with this bit set to 1 initializes the EVIN1 and 2 event input counters shown below to clear to 0.

EVIN1_EVCNT.EVCNT[5:0] bits (EVIN1 event counter)

EVIN2_EVCNT.EVCNT[5:0] bits (EVIN2 event counter)

Bit 4: BUF1FCLREN

This bit specifies whether to initialize the buffer status flags when a command trigger is executed.

1 (R/W): Buffer status flag is initialized.

0 (R/W): Buffer status flag is not initialized.

Executing a command trigger with this bit set to 1 initializes the buffer status flags shown below to set the buffer into empty status.

BUF1_STAT.FULLF bit (Buffer full flag)

BUF1_STAT.EMPTF bit (Buffer empty flag)

BUF1_STAT.OVWF bit (Buffer overwrite flag)

Bit 0: CMDTRGEN

This bit specifies whether to issue a time stamp trigger when a command trigger is executed.

1 (R/W): Time stamp trigger is issued.

0 (R/W): Time stamp trigger is not issued.

0x42: WRCMD_TRG (Write Command Trigger)

Bit No.	bit7	bit6	bit5	bit4	bit3	bit2	bit1	bit0
Bit Name	WRTRG[7:0]							
Initial value	0	0	0	0	0	0	0	0
R/W	R/W	R/W	R/W	R/W	R/W	R/W	R/W	R/W

Bits 7–0:WRTRG[7:0]

By writing any value to this address, a command trigger is issued to execute the command configured in Register WRCMD_CFG (Address 0x41).

0x43: EVNT_INTE (Event Interrupt Enable)

Bit No.	bit7	bit6	bit5	bit4	bit3	bit2	bit1	bit0
Bit Name	○	EVIN2IEN	EVIN1IEN	RSTOIEN	○	VTMPLIEN	○	OSCSTPIEN
Initial value	0	0	0	0	0	0	0	0
R/W	R	R/W	R/W	R/W	R	R/W	R	R/W

Bit 6: EVIN2IEN

Bit 5: EVIN1IEN

These bits enable/disable the EVINn event input to generate interrupts.

1 (R/W): EVINn event input interrupts are enabled.

0 (R/W): EVINn event input interrupts are disabled.

Bit 4: RSTOIEN

This bit enables/disables the reset output function (to detect if the VDD voltage drops below the VDD drop detection voltage) to issue event triggers. This bit is effective only in the models with the /RST pin.

1 (R/W): Reset output event trigger is enabled.

0 (R/W): Reset output event trigger is disabled.

If this bit has been set to 1, an event flag (EVNT_INTF.RSTOEVF bit) is set to 1 when a reset output is started (VDD voltage drop below the VDD drop detection voltage is detected).

Bit 2: VTMP LIEN

This bit enables/disables the V_{TEMP} voltage drop detection function (to detect if the VDD voltage drops below the lower limit of temperature compensation operating voltage for the oscillator circuit) to issue event triggers.

1 (R/W): V_{TEMP} voltage drop detection event trigger is enabled

0 (R/W): V_{TEMP} voltage drop detection event trigger is disabled.

If this bit has been set to 1, an event flag (EVNT_INTF.VTMP LEVF bit) is set to 1 when a V_{TEMP} voltage drop is detected.

Bit 0: OSCSTPIEN

This bit enables/disables the oscillation stop detection function to issue event triggers.

1 (R/W): Oscillation stop detection event trigger is enabled.

0 (R/W): Oscillation stop detection event trigger is disabled.

If this bit has been set to 1, an event flag (EVNT_INTF.OSCSTPEVF bit) is set to 1 when an oscillation stoppage is detected.

0x44: CAP_EN (Capture Enable)

Bit No.	bit7	bit6	bit5	bit4	bit3	bit2	bit1	bit0
Bit Name	○	○	○	RSTOCPEN	○	VTMPLCPEN	○	OSCSTPCPEN
Initial value	0	0	0	0	0	0	0	0
R/W	R	R	R	R/W	R	R/W	R	R/W

Bit 4: RSTOCPEN

This bit enables/disables the reset output (to detect if the VDD voltage drops below the VDD drop detection voltage) event trigger to capture time stamp data.

1 (R/W): Reset output time stamp capturing is enabled.

0 (R/W): Reset output time stamp capturing is disabled.

Bit 2: VTMPLCPEN

This bit enables/disables the VDET2 voltage drop detection (to detect if the VDD voltage drops below the lower limit of temperature compensation operating voltage for the oscillator circuit) event trigger to capture time stamp data.

1 (R/W): V_{TEMP} voltage drop detection time stamp capturing is enabled.

0 (R/W): V_{TEMP} voltage drop detection time stamp capturing is disabled.

Bit 0: OSCSTPCPEN

This bit enables/disables the oscillation stop detection event trigger to capture time stamp data.

1 (R/W): Oscillation stop detection time stamp capturing is enabled.

0 (R/W): Oscillation stop detection time stamp capturing is disabled.

0x45: INTF_MIR (Mirrored Status Flag, = 0x0E)

Bit No.	bit7	bit6	bit5	bit4	bit3	bit2	bit1	bit0
Bit Name	PORF	OSCSTPF	UF	TF	AF	EVF	VLF	VTMPLF
Initial value	1	1	0	0	0	0	1	1
R/W	R/W	R/W	R/W	R/W	R/W	R	R/W	R/W

This is a mirror register of Register INTF. For more information, refer to “0x0E: INTF (Status Flag).”

0x46: BUF_INTF (Buffer Interrupt Factor)

Bit No.	bit7	bit6	bit5	bit4	bit3	bit2	bit1	bit0
Bit Name	○	○	BUF1F	RSTOF	○	○	○	○
Initial value	0	0	0	1	0	0	0	0
R/W	R	R	R	R/W	R	R	R	R

Bit 5: BUF1F

These flags indicate that a time stamp buffer event trigger input interrupt factor has occurred.

1 (R): An event trigger input has occurred.

0 (R): No event trigger input has occurred.

This flag is set to 1 when a buffer full occurred.

The BUF1F bit is cleared to 0 when a command trigger for resetting these flags (BUF1_STAT.FULLF bit = 0, BUF1_STAT.EMPTF bit = 1, BUF1_STAT.OVWF bit = 0) is issued. This flag must be cleared to accept the subsequent event and to output an interrupt.

Bit 4: RSTOF

This flag is set when a reset output has started (VDD voltage drop below the VDD drop detection voltage is detected).

1 (R): Reset output has started. (VDD voltage drop below -V_{DET} has been detected.)

0 (R): Reset output has not started. (No VDD voltage drop has been detected.)

1 (W): Ineffective

0 (W): Flag clear (Takes effect after the VDD voltage is restored.)

If a VDD voltage drop status is being continued, this flag cannot be cleared by writing 0. This flag must be cleared to accept the subsequent event and to output an interrupt.

0x47: EVNT_INTF (Event Interrupt Factor)

Bit No.	bit7	bit6	bit5	bit4	bit3	bit2	bit1	bit0
Bit Name	○	EVIN2F	EVIN1F	RSTOEVF	○	VTMPLEVF	○	OSCSTPEVF
Initial value	0	0	0	0	0	0	0	0
R/W	R	R/W	R/W	R/W	R	R/W	R	R/W

Bit 6: EVIN2F

Bit 5: EVIN1F

These flags indicate that an event input has occurred to EVINn.

1 (R): An EVINn event input has occurred.

0 (R): No EVINn event input has occurred.

1 (W): Ineffective

0 (W): Flag clear

Bit 4: RSTOEVF

This flag indicates that a reset output event (the VDD voltage drops below the VDD drop detection voltage) has occurred.

1 (R): Reset output event has occurred.

0 (R): No reset output event has occurred.

1 (W): Ineffective

0 (W): Flag clear

Bit 2: VTMPLEVF

This flag indicates that a VDET2 voltage drop detection event (the VDD voltage drops below the lower limit of temperature compensation operating voltage for the oscillator circuit) has occurred.

1 (R): A VDET2 voltage drop detection event has occurred.

0 (R): No VDET2 voltage drop detection event has occurred.

1 (W): Ineffective

0 (W): Flag clear

Bit 0: OSCSTPEVF

This flag indicates that an oscillation stop detection event has occurred.

1 (R): An oscillation stop detection event has occurred.

0 (R): No oscillation stop detection event has occurred.

1 (W): Ineffective

0 (W): Flag clear

When an oscillation stop detection event has occurred, time stamp data will be captured after the oscillation restarts.

0x4B: CL_CONTROL_OFFSET

Bit No.	bit7	bit6	bit5	bit4	bit3	bit2	bit1	bit0
Bit Name	CL_CONTROL_OFFSET[7:0]							
Initial value	0	0	0	0	0	0	0	0
R/W	R/W	R/W	R/W	R/W	R/W	R/W	R/W	R/W

As the frequency offset adjust register, step is about 0.063ppm.

CL_CONTROL_OFFSET[7:0]	The adjusted ppm of the theory
0x7F	8.001ppm
0x7E	7.938ppm
0x7D	7.875ppm
...	
0x03	0.189ppm
0x02	0.126ppm
0x01	0.063ppm
0x00	0ppm
0xFF	-0.063ppm
0xFE	-0.126ppm
0xFD	-0.189ppm
...	
0x83	-7.875ppm
0x82	-7.938ppm
0x81	-8.001ppm
0x80	Setting prohibited

frequency offset adjust data for reference:

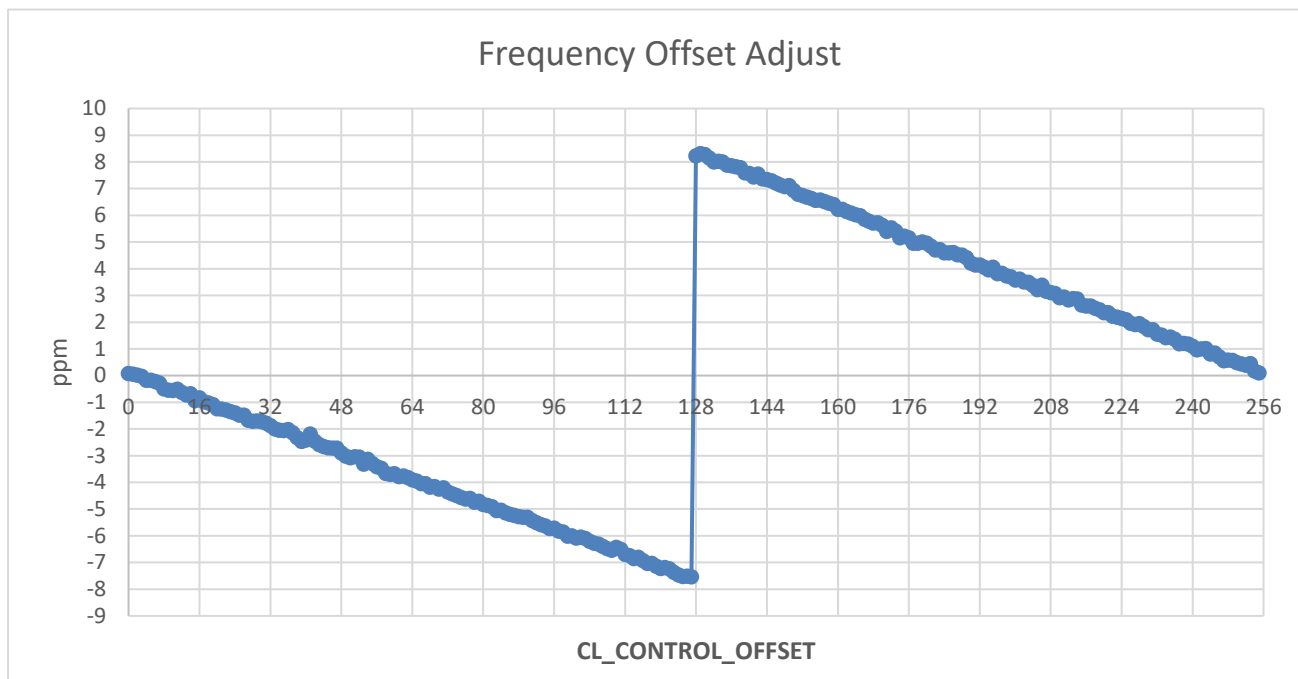

0x4C: TEMP_CL_FIT

Bit No.	bit7	bit6	bit5	bit4	bit3	bit2	bit1	bit0
Bit Name	○	○	○	○	CL_ALFA_CFG[1:0]		TEMP_ALFA_CFG[1:0]	
Initial value	0	0	0	0	0	0	0	0
R/W	R/W	R/W	R/W	R/W	R/W	R/W	R/W	R/W

Bit 3-2 CL_ALFA_CFG:

Temperature-compensated capacitive filtering.

CL_ALFA_CFG[1:0]	Description
2b'00	The proportion of the new CL: 100%, filtering has no effect.
2b'01	The proportion of the new CL: 1/8.
2b'10	The proportion of the new CL: 1/4.
2b'11	The proportion of the new CL: 1/2.

Bit 1-0 TEMP_ALFA_CFG:

Temperature-compensated temperature filtering.

TEMP_ALFA_CFG[1:0]	Description
2b'00	The proportion of the new temperature: 100%, filtering has no effect.
2b'00	The proportion of the new temperature: 1/2.
2b'00	The proportion of the new temperature: 1/4.
2b'00	The proportion of the new temperature: 1/8.

0x4D: SOFT_RST1

Bit No.	bit7	bit6	bit5	bit4	bit3	bit2	bit1	bit0
Bit Name	SOFT_RST1[7:0]							
Initial value	0	0	0	0	0	0	0	0
R/W	R/W	R/W	R/W	R/W	R/W	R/W	R/W	R/W

0x4E: SOFT_RST2

Bit No.	bit7	bit6	bit5	bit4	bit3	bit2	bit1	bit0
Bit Name	SOFT_RST2[7:0]							
Initial value	0	0	0	0	0	0	0	0
R/W	R/W	R/W	R/W	R/W	R/W	R/W	R/W	R/W

Soft reset function:

This function is used to reset the chip by software, after chip reset, all registers will set to its default value.

Please write below registers to reset chip:

0x4D = 0x00, 0x4E = 0x00; 0x4D = 0xA5, 0x4E = 0xD7;

0x51: EVIN1_EVCNT (EVIN1 Event Counter)
0x52: EVIN2_EVCNT (EVIN2 Event Counter)

Bit No.	bit7	bit6	bit5	bit4	bit3	bit2	bit1	bit0
Bit Name	○	○	EVCNT[5:0]					
Initial value	0	0	0	0	0	0	0	0
R/W	R	R	R	R	R	R	R	R

Bits 5–0: EVCNT[5:0]

These bits indicate the event count (0 to 63 times) input to the EVINn pin.

If the input count exceeds 63 times, the counter reverts to 0 and continues counting. The EVINn event

counter does not operate when the EVIN_EN.EVINnEN bit = 0.

0x54: EVINMON (EVIN Monitor)

Bit No.	bit7	bit6	bit5	bit4	bit3	bit2	bit1	bit0
Bit Name	○	EVIN2MON	EVIN1MON	○	○	○	○	○
Initial value	0	0	0	0	0	0	0	0
R/W	R	R	R	R	R	R	R	R

Bit 6: EVIN2MON

Bit 5: EVIN1MON

These bits indicate the current input level on the EVINn pin.

1 (R): High level

0 (R): Low level

0x55: SOUTCTL (SOUT Control)

Bit No.	bit7	bit6	bit5	bit4	bit3	bit2	bit1	bit0
Bit Name	DCE	DC	○	○	SIGINV	SOUT[2:0]		
Initial value	0	0	0	0	0	0	0	0
R/W	R/W	R/W	R	R	R/W	R/W	R/W	R/W

Bit 7: DCE

This bit enables/disables DC output from the SOUT pin.

1 (R/W): DC output is enabled.

0 (R/W): DC output is disabled (status flag output or Hi-Z state)

Bit 6: DC

This bit sets the DC level output from the SOUT pin when the DCE bit = 1.

1 (R/W): High level

0 (R/W): Low level

The two-bit combination of DCE and DC allows selection of an SOUT output status as shown in the table below.

SOUT Output Selections

SOUTCTL.DCE	SOUTTCL.DC	SOUT pin out status
0b0	0b0	Hi-Z
0b0	0b1	According to SIGINV and SOUT[2:0] bit settings
0b1	0b0	Low output
0b1	0b1	High output

Bit 3: SIGINV

This bit selects whether the output level is inverted or not when a status flag is output from the SOUT pin.

1 (R/W): Inverted output (When the flag = 1: Low level output; when the flag = 0: High level output)

0 (R/W): Non-inverted output (When the flag = 1: High level output; when the flag = 0: Low level output) The invert setting with this bit is ineffective when the DCE bit = 1.

Bits 2–0: SOUT[2:0]

These bits select the status flag to be output from the SOUT pin. This selection is effective only when the DCE bit = 0.

SOUT Output table Internal Status Flags

SOUTCTL.SOUT[2:0]	Status flag
0b000	INTF.TF bit (Wakeup timer interrupt flag)
0b001	INTF.AF bit (Alarm interrupt flag)
0b010	INFF.UF bit (Time update interrupt flag)
0b011	INTF.EF bit (Event detection interrupt flag)
0b100	INTF.VTMPLF bit (Temperature compensation operation stop detection flag)
0b101	INTF.VLF bit (Invalid date and time data warning flag)
0b110-0b111	Reserved

8 SPI interface

8.1 Pin description

For Option D/E SPI interface pins

PIN	Description
DI	SPI data in pin
DO	SPI data out pin
CLK	SPI clock input pin
CE	SPI slave select pin(300KΩ pull down)

For Option A/B/C SPI interface pins

PIN	Description
DIO	SPI data in/out pin
CLK	SPI clock input pin
CE	SPI slave select pin(300KΩ pull down)

INS5A4000 is a slave driver. Below pictures show INS5A4000 connect to HOST.

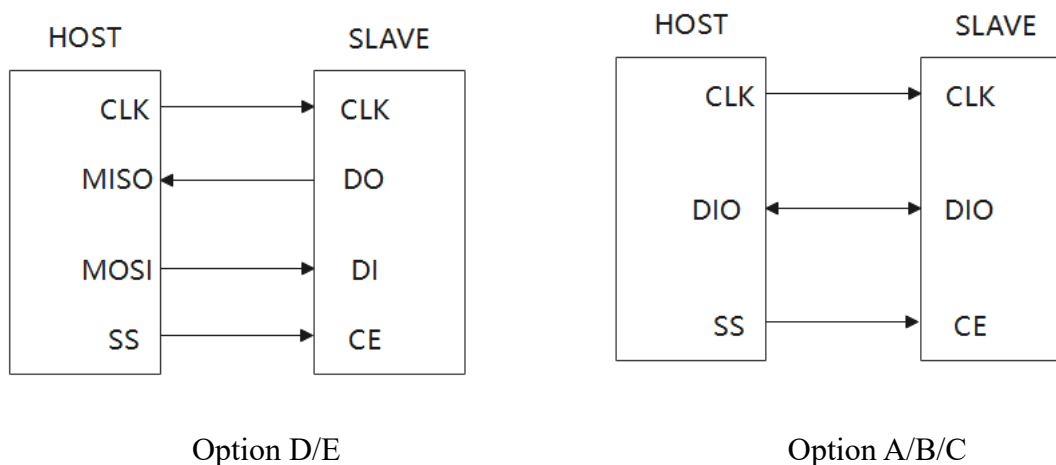

8.2 Write data

INS5A4000 is select as slave driver when the host sets the CE signal to high. Then it starts outputting a clock and an 8-bit address data (register address to which the first data is written) including a bit8 to specify write mode via DIO/DI, and write data follows in eight-bit units. Below shows the bit configuration of the address.

BIT7	BIT6	BIT5	BIT4	BIT3	BIT2	BIT1	BIT0
0: Write mode 1: Read mode	7-bit address (0b000 0000–0b111 1111)						

Below shows INS5A4000 register data write operations. 1bit Write/Read mode + 7bits Address + 8bits Write Value +.....+ (7bits Address+1) + 8bits Write Value..... The low 4 bits of address will increase automatically from 0x0 to 0xF, then reset to 0x0. The high 3 bits of address don't increase automatically. Therefor to change the high 3 bits should restart CE signal, and change address.

Single register write operation

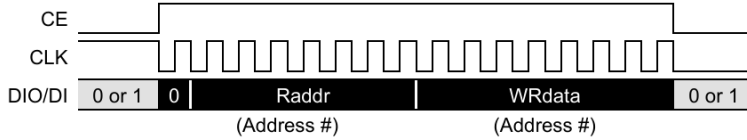

Continuous register write operation

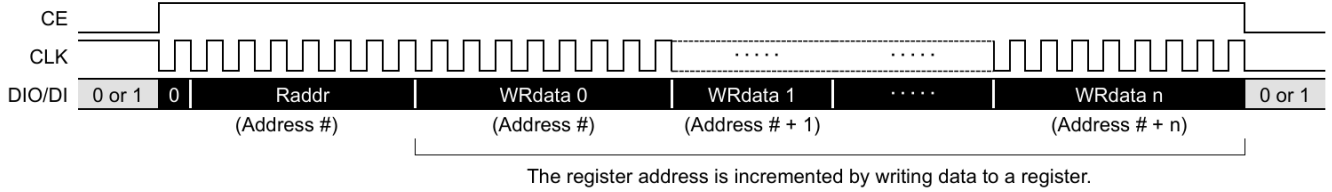

8.3 Read data

In this mode, INS5A4000 address bit8 should be set to 1.

BIT7	BIT6	BIT5	BIT4	BIT3	BIT2	BIT1	BIT0
0: Write mode 1: Read mode	7-bit address (0b000 0000–0b111 1111)						

Below shows INS5A4000 register data read operations. The low 4 bits of address will increase automatically from 0x0 to 0xF, then reset to 0x0. The high 3 bits of address don't increase automatically. Therefore to change the high 3 bits should restart CE signal, and change address.

Single register read operation

INS5A4000 Option A/B/C

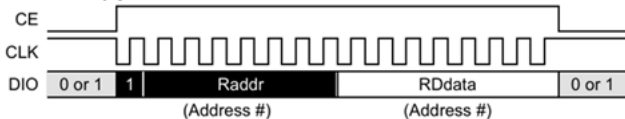

INS5A4000 Option D/E



Continuous register read operation

INS5A4000 Option A/B/C

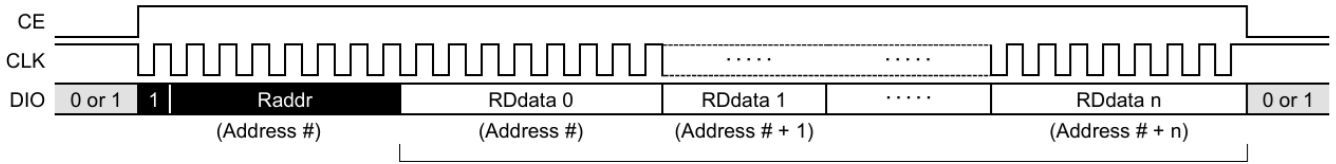

The register address is incremented by reading data from a register.

INS5A4000 Option D/E

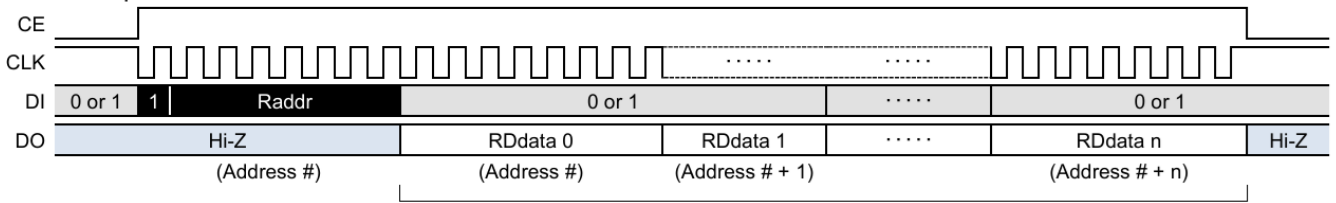

The register address is incremented by reading data from a register.

9 Reflow Soldering Curve

Standard: IPC/JEDEC J-STD-020

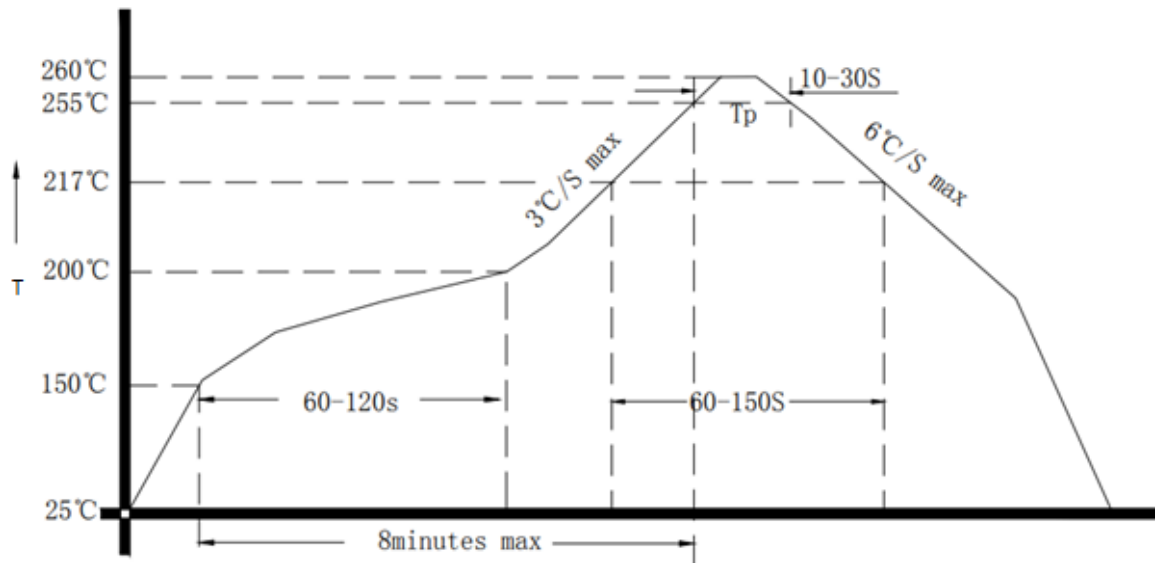

Figure 3. Reflow Soldering Curve

Note: It is suggested to solder IC under the condition shown in the curve above. Must pay attention to the temperature and time when manual soldering, if the temperature over +260°C, or you will make the xo performance bad, even damage it.

10 Dimensions

Dimension/mm	Sym.	Min.	Typ.	Max.
	A	3.0	3.2	3.4
	B	2.3	2.5	2.7
	C	0.9	1.0	1.1
	E	-	0.3	-
	F	-	0.4	-
	G	-	0.6	-
	H	-	1.3	-
	F1	-	0.45	-
	F2	-	0.3	-

Soldering Pattern/mm	Sym.	Max.
	A	0.9
	B	1.1
	C	0.4
	D	0.3
	E	0.7

● Marking

	Frist Line	5A4000	Part Num
		X	Option A/B/C/D/E
	Second Line	XXXXXXXX	Tracking codes and date codes
	Third Line	XXX	Internal codes
	Fourth Line	●	Pin 1

11 Package

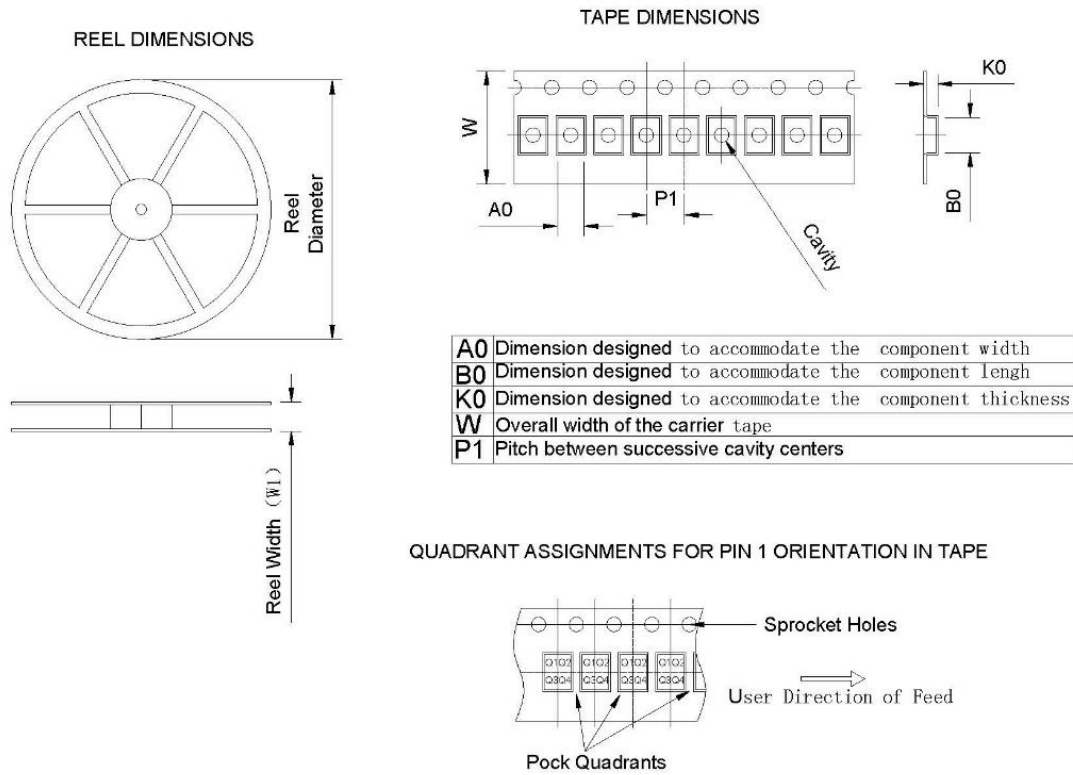

Figure 4. Package

Device	Package Type	Pins	SPQ	Reel Diameter (mm)	Reel Width W1(mm)	A0 (mm)	B0 (mm)	K0 (mm)	P1 (mm)	W (mm)	PIN1 Quadrant
INS5A4000	LGA	10	3000	180	11.6±2.0	3.00	3.70	1.50	4	8.00	Q1

12 Revision History

Version	Change Contents	Prepared by	Revised Date
1.0	First Issued		2025.01.14