

5mm SMD ISOLATOR

RF component

Datasheet Rev.: A
Date: 2024/11/19

Customer:

Product Name:

DP-IL0525A950
DP-IL0525B950

Customer P/N:



GuangdongDapuTelecomTechnologyCo.,Ltd Building5, No.24, Gongye East Road,
<http://www.dptel.com> SSL Sci & Tech Industry Park,
Dongguan, Guangdong, China
TEL: 0086-0769-88010888
FAX: 0086-0769-81800098

Approved	Checked	Designer
Nick	Wison	ZC.Wu

5mm SMD ISOLATOR

RF component

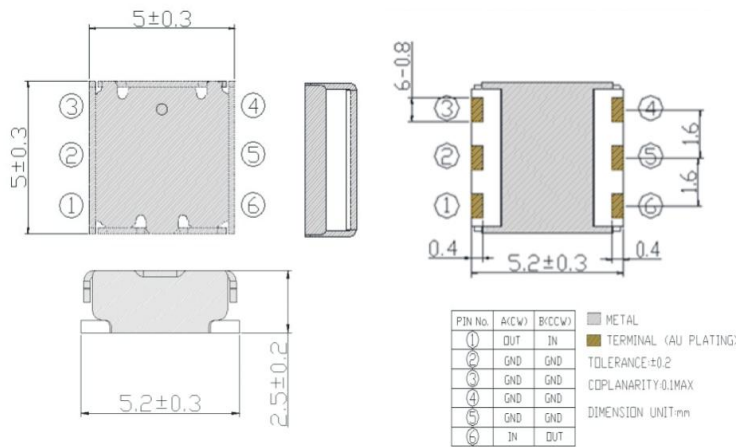
 Datasheet Rev.: A
 Date: 2024/11/19
MECHANICAL SPECIFICATION

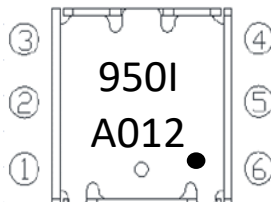
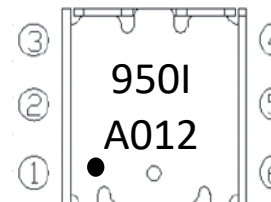
MARKING

Clockwise DP-IL0525A950	CounterClockwise DP-IL0525B950	①/⑥ : Out/In Port ②~⑤: Ground I: Isolator A: Year 01: Week of Year 2: Day of Week ●: Input Port
		

Year Code	
Year	Code
2019	A
2020	B
2021	C
2022	D
2023	E
2024	F
...	...

Week Code	
Week	Code
1	01
2	02
3	03
4	04
5	05
6	06
...	...

Day Code	
Day	Code
Monday	1
Tuesday	2
Wednesday	3
Thursday	4
Friday	5
Saturday	6
Sunday	7

5mm SMD ISOLATOR

RF component

Datasheet Rev.: A
 Date: 2024/11/19

TEMPERATURE RANGE

Operating temperature range: -40~+85°C

Storage temperature range: -40~+125°C

ELECTRICAL CHARACTERISTICS

Parameter	Unit	Frequency (MHz)		DP Spec			
				Min.	Typ.	Max.	
Frequency range	MHz	940		960	940		960
Insertion Loss	dB	-		-			0.75
Isolation	dB	-		-	14		
Return Loss	dB	-		-	14		
IMD3 (2*25dBm, Span 5MHz)	dBc						
IMD3 typical	dBc						
Power Handling (Average)	W						5
Power Handling (Peak)	W						40
Reflection power	W						2
Attenuation 2f	dB						
Attenuation 3f	dB						
Characteristic Impedance (ohm)	Ω						50
Case Style	-						SMD

NOTES

1. Recommend to keep 30mm above when mounted with other magnetic products.
2. RoHS compliance.
3. Isolator's characteristics are guaranteed at conditions listed at above table and it's operating temperature range.

5mm SMD ISOLATOR

RF component

Datasheet Rev.: A
 Date: 2024/11/19

RECOMMENDED LAND PATTERN

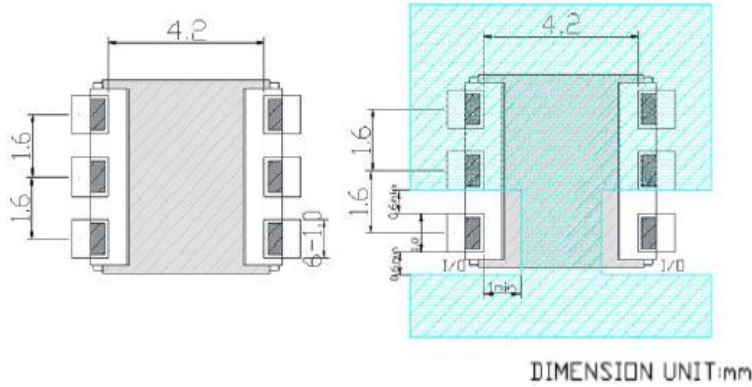

RECOMMENDED REFLOW PROFILE

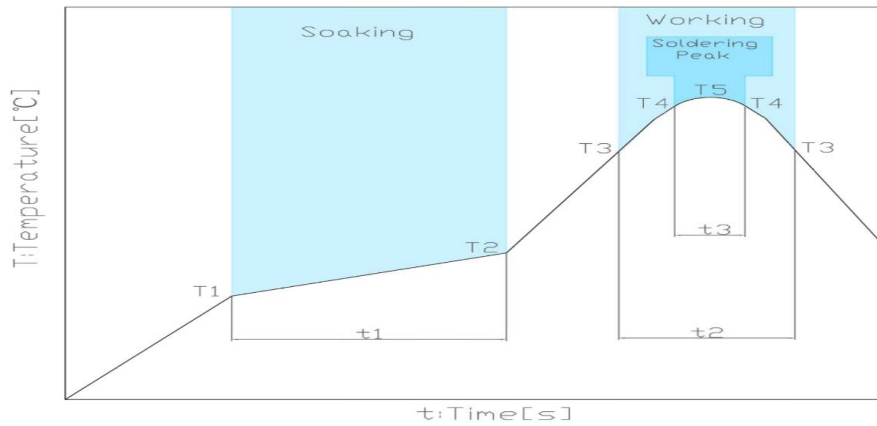

Soaking			Working		Soldering Peak		
Temp.	Time		Temp.	Time	Temp.	Time	Temp.
T1	T2	t1	T3	t2	T4	t3	T5
150°C	180°C	60 to 120s	230°C	30 to 60s	250°C	within 10s	260°C max.

5mm SMD ISOLATOR

RF component

Datasheet Rev.: A
 Date: 45615

PACKING STYLE

REEL DIMENSIONS

Reel side \longrightarrow Pulling side

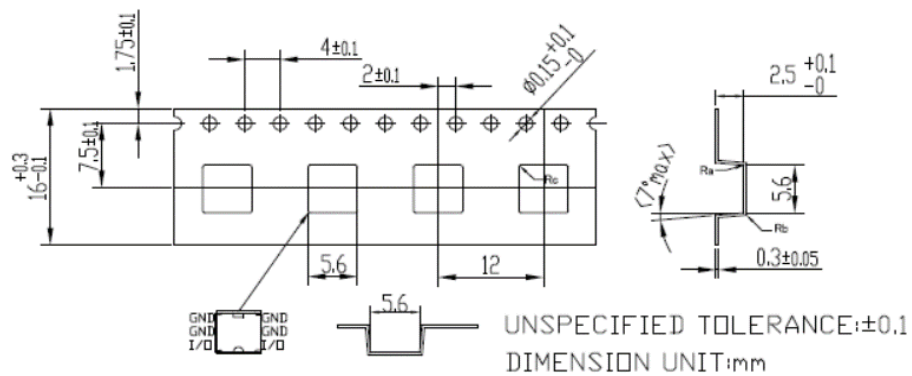

TAPE DIMENSIONS

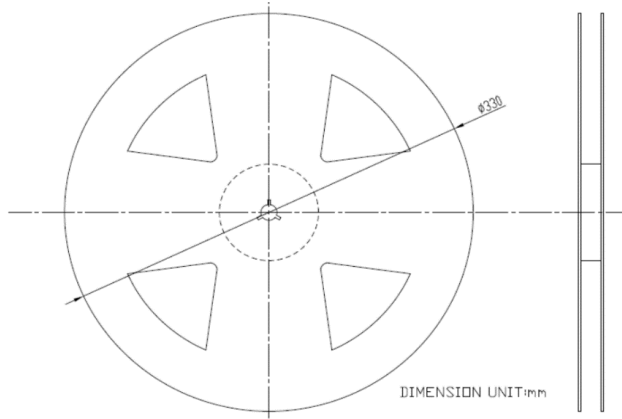

PACKAGE QUANTITY

1000 PCS/REEL

5mm SMD ISOLATOR

RF component

Datasheet Rev.: A
 Date: 2024/11/19

Revision Records

Rev.	Date	PIC	Change item	Reasons for change
A	2024.11.19	ZC.Wu	New release	
B				
C				
D				
E				
F				
G				
H				