

Customer Code: \_\_\_\_\_

# DATASHEET

DAPU P/N: DPA2225M0000EFB1

DAPU			Customer Approval
Drew	Audited	Approved	Stamp, please! Thanks!
Jack	David	William	
Date: 2022.11.14			

## Guangdong Dapu Telecom Technology Co.,Ltd

Building 5, No.24, Industrial East Road, Songshanhu Park, Dongguan, Guangdong, P.R. China

TEL: 0086-0769-88010888 FAX: 0086-0769-81800098



## 1、 Electrical Parameters

MODEL: DPA2225M0000EFB1							
No.	Parameters	SYM.	Electrical Spec.				Notes
			Min.	Typ.	Max.	Units	
1	Nominal Frequency	FL	25.00			MHz	
2	Oscillation Mode	-	Fundamental				
3	Frequency Tolerance	-	-10		+ 10	$\times 10^{-6}$	At 25°C
4	Frequency Stability	-	-20		+ 20	$\times 10^{-6}$	-40°C~85°C (Reference 25°C)
		-	-30		+ 30	$\times 10^{-6}$	-40°C~105°C (Reference 25°C)
5	Operating Temperature	Topr	-40	~	+ 105	°C	
6	Storage Temperature	Tstg	-55	~	+ 125	°C	
7	Supply Voltage	V <sub>DD</sub>	1.62		3.63	V	V <sub>DD</sub> ±10%
8	Input Current	I <sub>cc</sub>			10	mA	
9	Output waveform	-	CMOS				
10	Output Load	CL	15			pF	
11	Output Voltage High	V <sub>OH</sub>	90%			V <sub>DD</sub>	
12	Output Voltage Low	V <sub>OL</sub>			10%	V <sub>DD</sub>	
13	Rise Time	T <sub>r</sub>			5	ns	10%-90% V <sub>DD</sub> Level
14	Fall Time	T <sub>f</sub>			5	ns	90%-10% V <sub>DD</sub> Level
15	Aging	-	-3		+ 3	$\times 10^{-6}$	First Year at 25°C
16	Tri-State Output Enable	-	80%			V <sub>DD</sub>	Pin 1, OE
17	Tri-State Output Disable	-			20%	V <sub>DD</sub>	Pin 1, OE
18	Duty Cycle	-	40	~	60	%	
19	Start-Up Time	T <sub>start</sub>			3	ms	Measured from the time V <sub>DD</sub> reaches its rated minimum value
20	Phase Jitter(RMS)	-			0.3	ps	12kHz to 20MHz



## 2、 Mechanical Structure

### 2.1 Dimensions

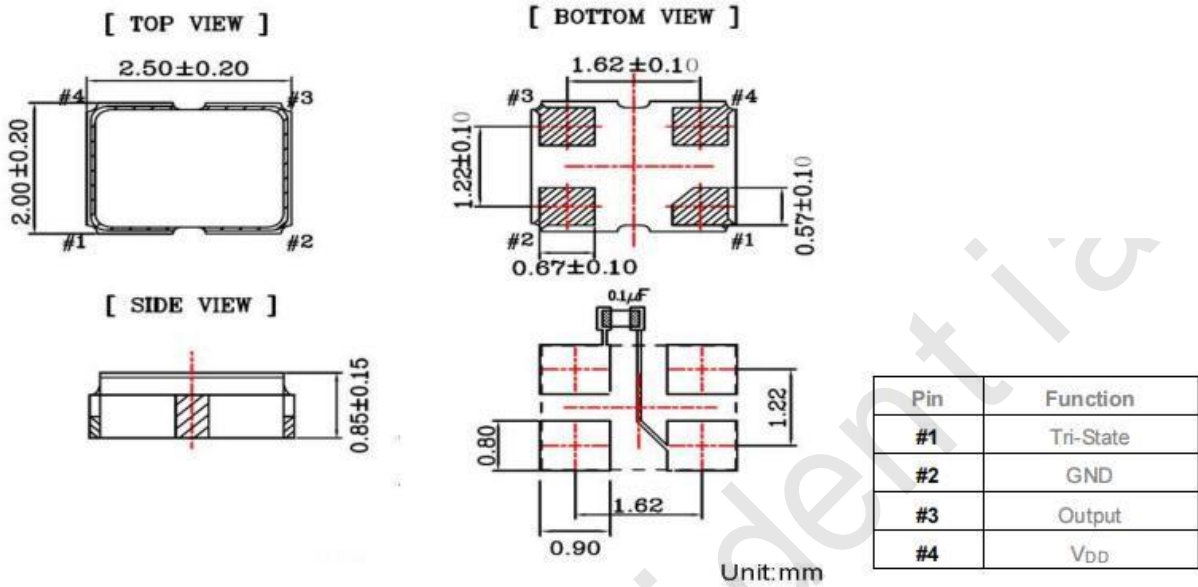

\*To ensure optimal oscillator performance, place a by-pass capacitor of 0.1μF as close to the part as possible between VDD and GND pads.

Unit: mm

### 2.2 Marking

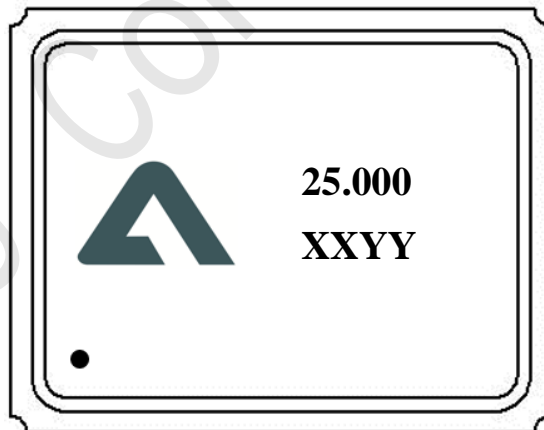

- DAPU LOGO
- 25.000 ----- Frequency
- XXYY ----- Manufactured day: XX      YY  
Year      Week
- ----- Pin 1



### 3、 Test Circuit

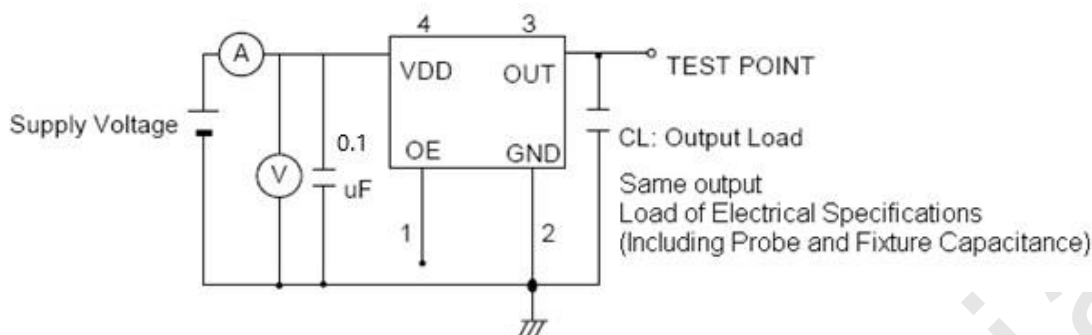

Control input (output enable/disable)

Logic 1 or open on pad 1: Oscillator output

Logic 0 on pad 1 : Disable output to high impedance

### 4、 Reflow Soldering Curve (RoHS)

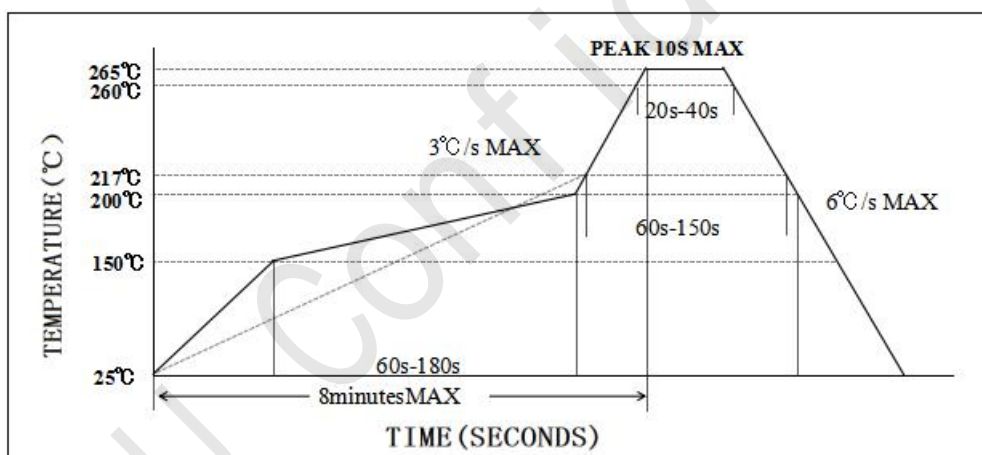

### 5、 Electro-static Discharges

HBM: Class3A

MM: ClassC

CDM: ClassIV

## 6、Package: Tape & Reel (mm)

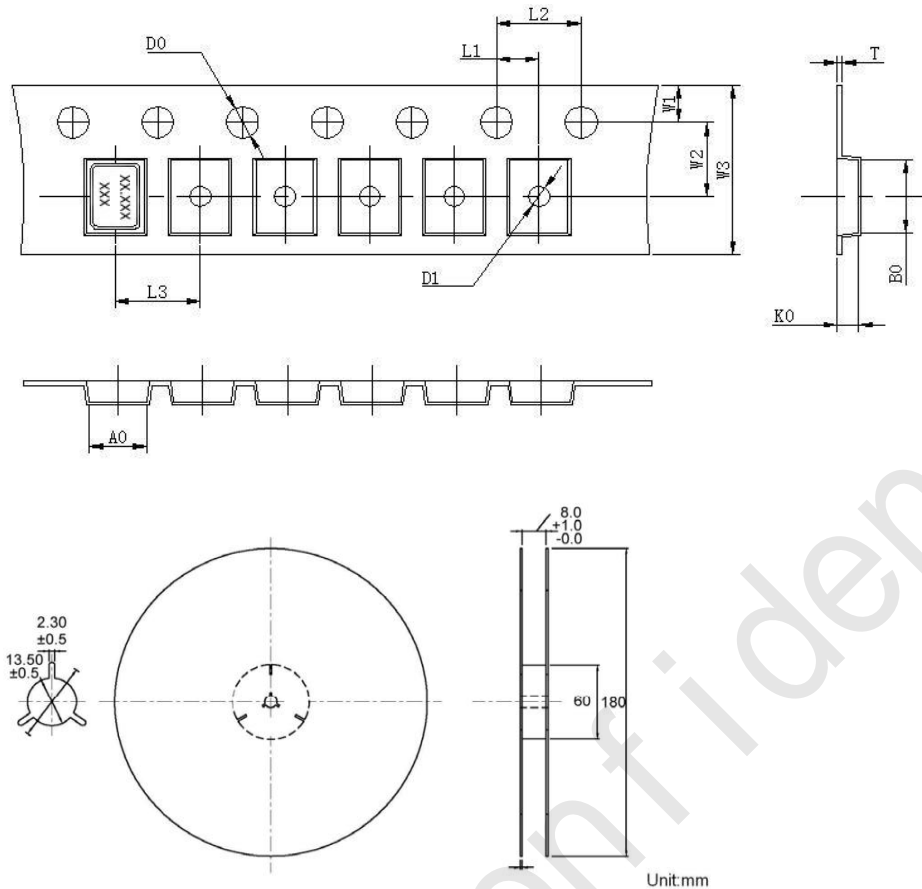

L1	2.00±0.1
L2	4.00±0.1
L3	4.00±0.1
D0	1.55±0.05
D1	1.20±0.5
W1	1.75±0.1
W2	3.50±0.1
W3	8.00±0.2
A0	2.25±0.1
B0	2.7±0.1
K0	1.45±0.1
T	0.25±0.05

## 7、Reliability Test Specification

NO.	Test Items	Test Standard	Test Condition	Specifications
1	Drop test	GB/T2423.8	Drop from 150cm height on 3cm hard wooden board for 3 times	
2	Mechanical shock	GB/T2423.5	Peak: 100g; Waveform: Half-sine; Velocity Change: 1000m/s <sup>2</sup> ; Duration: 0.5ms; 3 times/direction, Direction: +X, -X, +Y, -Y, +Z, -Z.	
3	Vibration	GB/T2423.10	Frequency: 10~2000Hz; Vibration:20min, 1.52mm; Direction: X, Y, Z; Duration: 2 hours/direction.	
4	Solderability	IEC60068-2-58	Soldering temperature:245°C ± 5°C Immersion time:5 seconds ± 0.5 seconds Flux:Rosin Resin Methanol Solvent ( 1 : 4 )	
5	Resistance to	IEC60068-2-58	Reflow soldering:	

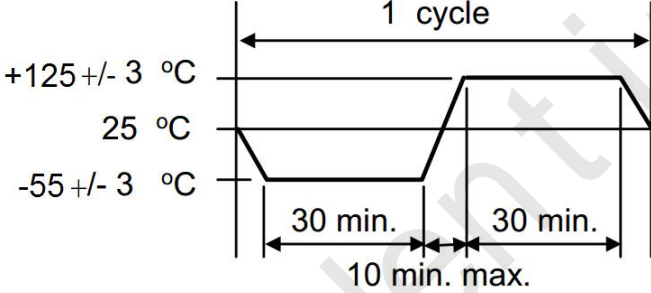

	soldering heat		Solder temperature $260\pm 5^{\circ}\text{C}$ , Immersion time: $10\pm 1$ S	Electrical performance meets specification requirements
6	High temperature storage	GB/T2423.2	Temperature: $125^{\circ}\text{C}\pm 2^{\circ}\text{C}$ ; Duration: $500\pm 12$ hours;	
7	Low temperature storage	GB/T2423.1	Temperature: $-40^{\circ}\text{C}\pm 2^{\circ}\text{C}$ ; Duration: $500\pm 12$ hours;	
8	Temperature Shock	GB/T2423.22	Do 10 cycles at the following temperature 	
9	High temperature high humidity storage	GB/T2423.3	Temperature: $85^{\circ}\text{C}\pm 3^{\circ}\text{C}$ ; Humidity: 85%; Duration: 500hours;	