

5mm SMD ISOLATOR

RF component

Datasheet Rev.: A
Date: 2023.10.27

Customer:

Product Name:

DP-IL0525A748
DP-IL0525B748

Customer P/N:



GuangdongDapuTelecomTechnologyCo.,Ltd Building5, No.24, Gongye East Road,
<http://www.dptel.com> SSL Sci & Tech Industry Park,
Dongguan, Guangdong, China
TEL: 0086-0769-88010888
FAX: 0086-0769-81800098

Approved	Checked	Designer
Nick	Wison	ZC.Wu

5mm SMD ISOLATOR

RF component

 Datasheet Rev.: A
 Date: 2023.10.27

MECHANICAL SPECIFICATION

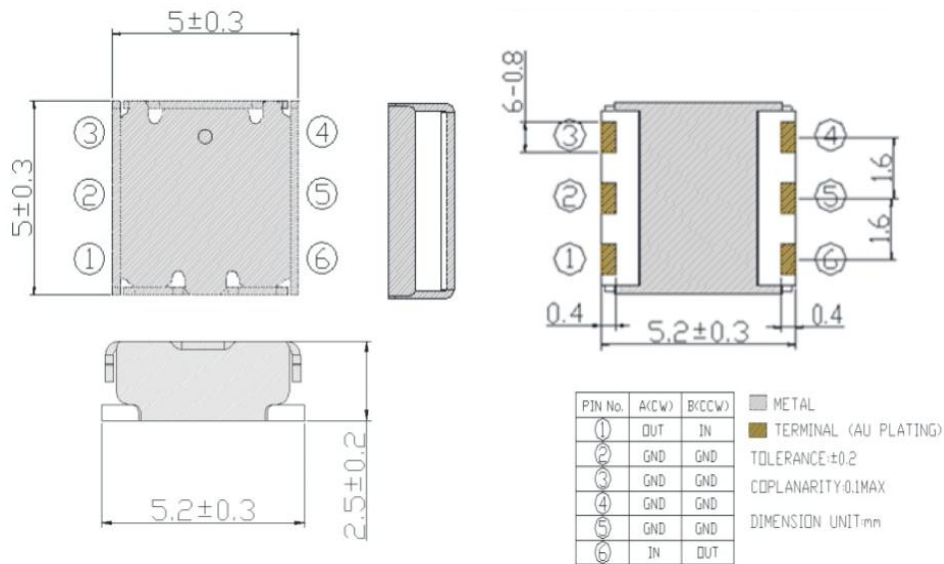

MARKING

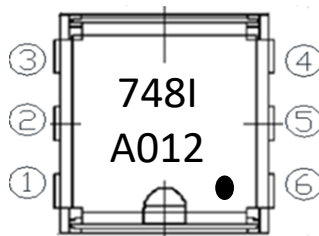
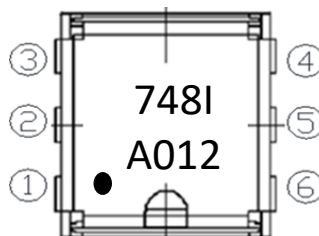
Clockwise DP-IL0525A748	CounterClockwise DP-IL0525B748	
		①/⑥ : Out/In Port ②~⑤: Ground I: Isolator A: Year 01: Week of Year 2: Day of Week ●: Input Port

Year Code	
Year	Code
2019	A
2020	B
2021	C
2022	D
2023	E
2024	F
...	...

Week Code	
Week	Code
1	01
2	02
3	03
4	04
5	05
6	06
...	...

Day Code	
Day	Code
Monday	1
Tuesday	2
Wednesday	3
Thursday	4
Friday	5
Saturday	6
Sunday	7

5mm SMD ISOLATOR

RF component

Datasheet Rev.: A
 Date: 2023.10.27

TEMPERATURE RANGE

Operating temperature range: -40~+85°C
 Storage temperature range: -55~+125°C

ELECTRICAL CHARACTERISTICS

Parameter	Unit	Frequency (MHz)		DP Spec			
				Min.	Typ.	Max.	
Frequency range	MHz	729		768	729		768
Insertion Loss	dB	-		-			1.00
Isolation	dB	-		-	10		
Return Loss	dB	-		-	11		
Power Handling (Average)	W						5
Power Handling (Peak)	W						10
Reflection power	W						2
Characteristic Impedance (ohm)	Ω					50	
Case Style	-					SMD	

NOTES

1. Recommend to keep 30mm above when mounted with other magnetic products.
2. RoHS compliance.
3. Isolator's characteristics are guaranteed at conditions listed at above table and it's operating temperature range.

5mm SMD ISOLATOR

RF component

Datasheet Rev.: A
 Date: 2023.10.27

PACKING STYLE

REEL DIMENSIONS

Reel side \longrightarrow Pulling side

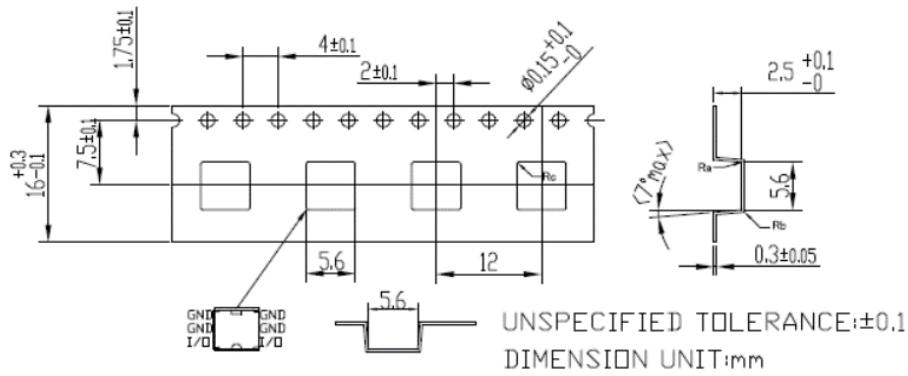

TAPE DIMENSIONS

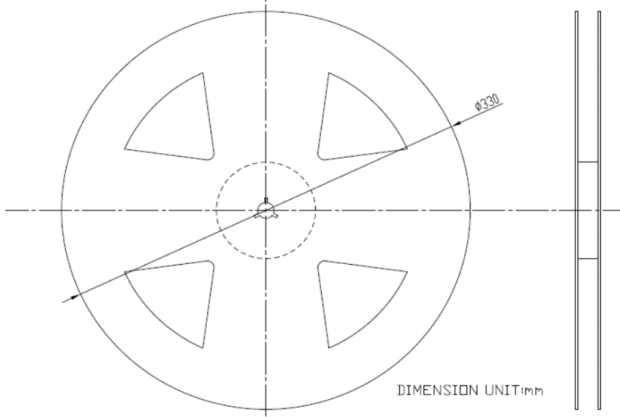

PACKAGE QUANTITY

2000 PCS/REEL

5mm SMD ISOLATOR

RF component

Datasheet Rev.: A
 Date: 2023.10.27

Revision Records

Rev.	Date	PIC	Change item	Reasons for change
A	2023.10.27	ZC.Wu	New Release	
B				
C				
D				
E				
F				
G				
H				