

Travelling Merchant: _____

DATASHEET

Standard: DP5X32768006

RDTEMPH900477

Plot			The Label
Drew	Audited	Approved	Stamp, please! Thanks!
Date: 2023.06.25			

Guangdong Dapu Telecom Technology Co.,LTD

Building 5, No.24, Industrial East Road, Songshanhu Park, Dongguan, Guangdong, P.R. China

TEL: 0086-0769-88010888 FAX: 0086-0769-81800098



1. Electrical Parameters

MODEL: DP5X32768006							
No.	Parameters	SYM.	Electrical Spec.				Notes
			Min.	Typ.	Max.	Units	
1	Nominal Frequency	FL	32.768			KHz	
2	Oscillation Mode	-	Fundamental			-	
3	Load Capacitance	CL	7			pF	
4	Frequency Tolerance	-	-20		+20	$\times 10^{-6}$	$T_A=25^{\circ}\text{C} \pm 3^{\circ}\text{C}$
5	Parabolic Coefficient	-			-0.04	ppm/ $^{\circ}\text{C}^2$	
6	Operating Temperature	-	-40		+85	$^{\circ}\text{C}$	
7	Storage Temperature Range	-	-55		+125	$^{\circ}\text{C}$	
8	Aging Per Year	-	-3		+3	$\times 10^{-6}$	
9	Drive Level	DL		0.1	0.5	μW	
10	Motional capacitance	C1		4.65		fF	
11	Shunt Capacitance	C0		1.15		pF	
12	Insulation Resistance	-	500	-	-	M Ω	At DC 100V
13	Quality Factor	Q	13			K	
14	Equivalent Series Resistance	ESR			70	K Ω	



2. Mechanical Structure(mm)

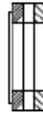
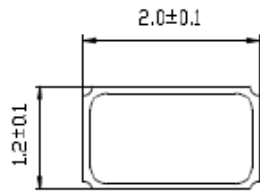

<TOP VIEW>

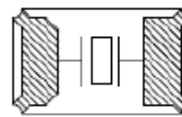
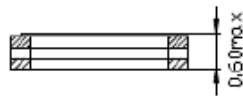

LAND PATTERN(REFERENCE)

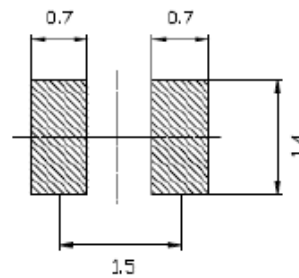
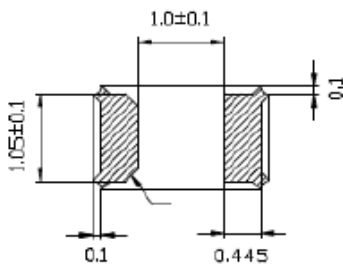

MARKING

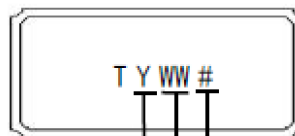

T Y WW #

: Load

WW: Week

Y :Year code

Year : 2021 2022 2023 2024 2025 2026 2027 2028 2029 2030

Code : 1 2 3 4 5 6 7 8 9 0

(*The Year code will be cycled every ten years.)

WW : Week

#Load : A→12.5PF、B→9PF、C→7PF、D→6PF



3. Package: Tape & Reel (mm)

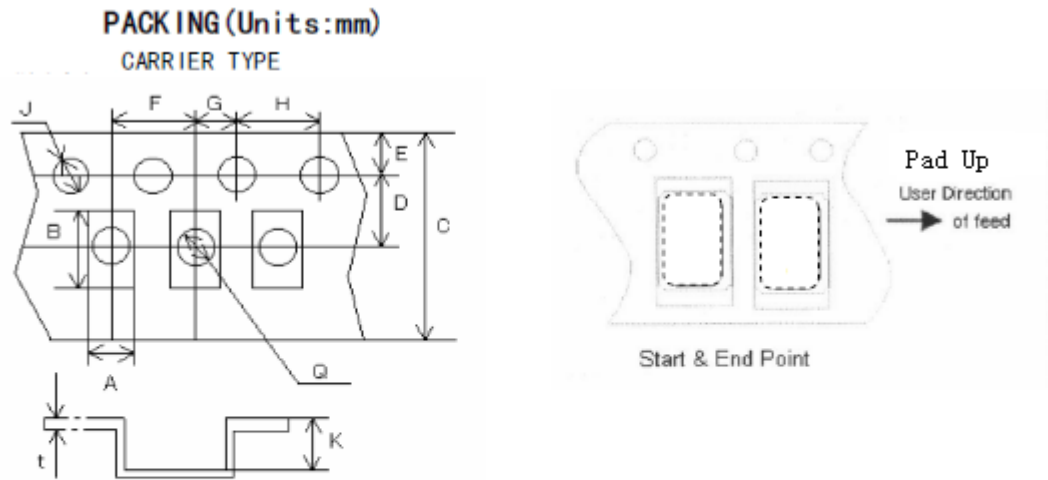

A	B	C	D	E	F	G	H	J	K	t
1.4	2.3	8.0	3.5	1.75	4.0	2.0	4.0	1.5	0.75	0.25

REMARK:

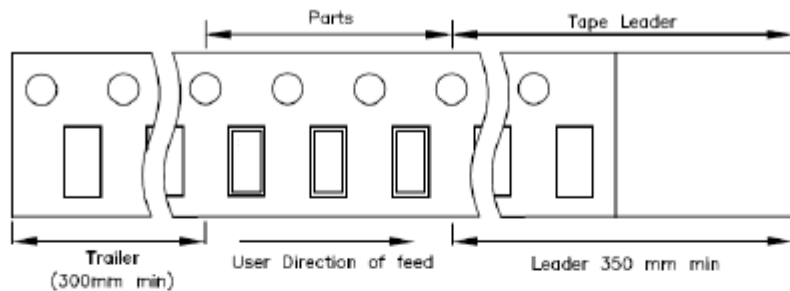

REEL: 3000 PCS/Reel

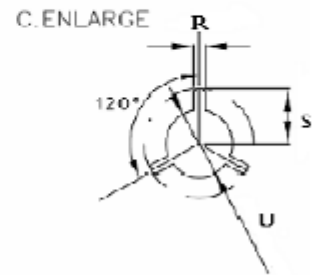
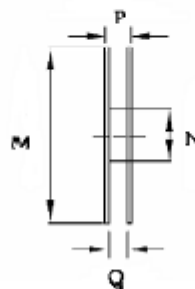
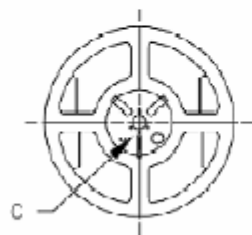

M	N	P	Q	R	S	U
178	60.2	11.5	8.0	2.5	11.0	13.0