

Travelling Merchant: \_\_\_\_\_

# DATASHEET

Standard: DPAM30M00002

Plot			The Label
Drew	Audited	Approved	Stamp, please! Thanks!
Ella	Carry	Jason	
Date: 2023.10.25			

## Guangdong Dapu Telecom Technology Co.,Ltd

Building 5, No.24, Industrial Road East, Songshanhu Park, Dongguan, Guangdong, P.R. China

TEL: 0086-0769-88010888 FAX: 0086-0769-81800098



## 1、 Electrical Parameters

MODEL: DPAM30M00002							
No.	Parameters	SYM.	Electrical Spec.				Notes
			Min.	Typ.	Max.	Units	
1	Nominal Frequency	FL	30.000			MHz	
2	Mode of Vibration	-	Fundamental/AT-CUT			-	
3	Load Capacitance	CL	12			pF	
4	Frequency Tolerance	-	-10	-	+10	$\times 10^{-6}$	At 25°C± 2°C
5	Frequency Stability Over Operating Temp. Range	-	-30	-	+30	$\times 10^{-6}$	@ 25°C
7	Aging	-	-3	-	+3	$\times 10^{-6}$	Per Year
8	Drive Level	DL	1	100	200	$\mu$ W	
9	Effective Resistance Rr	Rr	-	-	30	$\Omega$	
10	Shunt Capacitance C0	C0	-	-	3	pF	
11	Insulation Resistance	-	500	-	-	M $\Omega$	At DC 100V
12	Operating Temperature		-40	~	+85	°C	
13	Storage Temperature Range	-	-55	~	+125	°C	
14	Moisture Sensitivity Level	Level 1.					

## 2、 Mechanical Structure(mm)

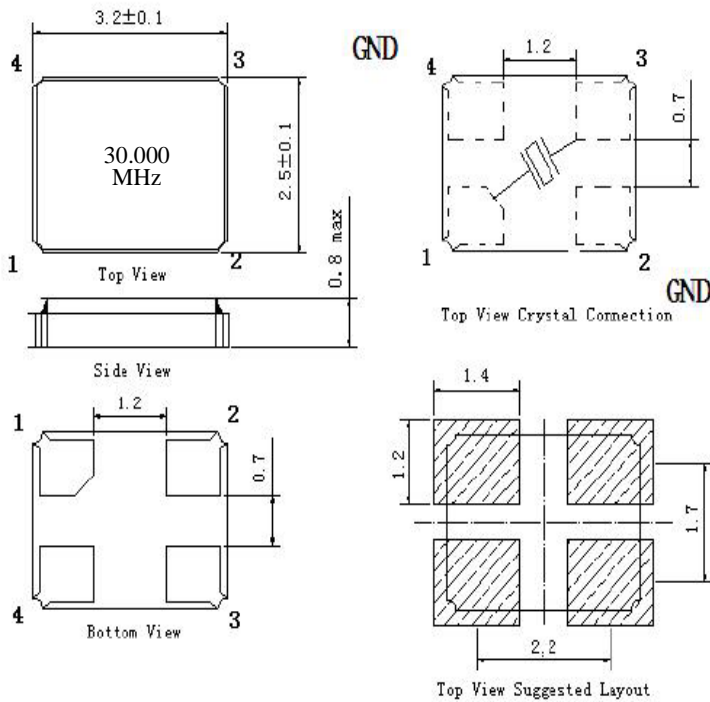

Pin 1	Xtal
Pin 2	GND
Pin 3	Xtal
Pin 4	GND



### 3、 Reflow Soldering Curve (RoHS)

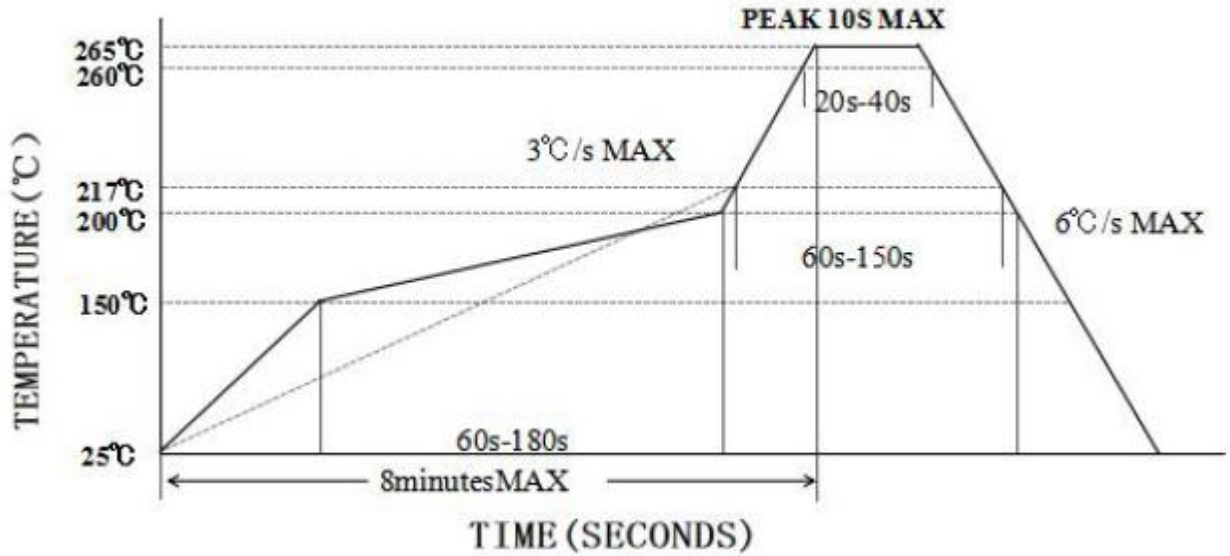

### 4、 Packing(mm)

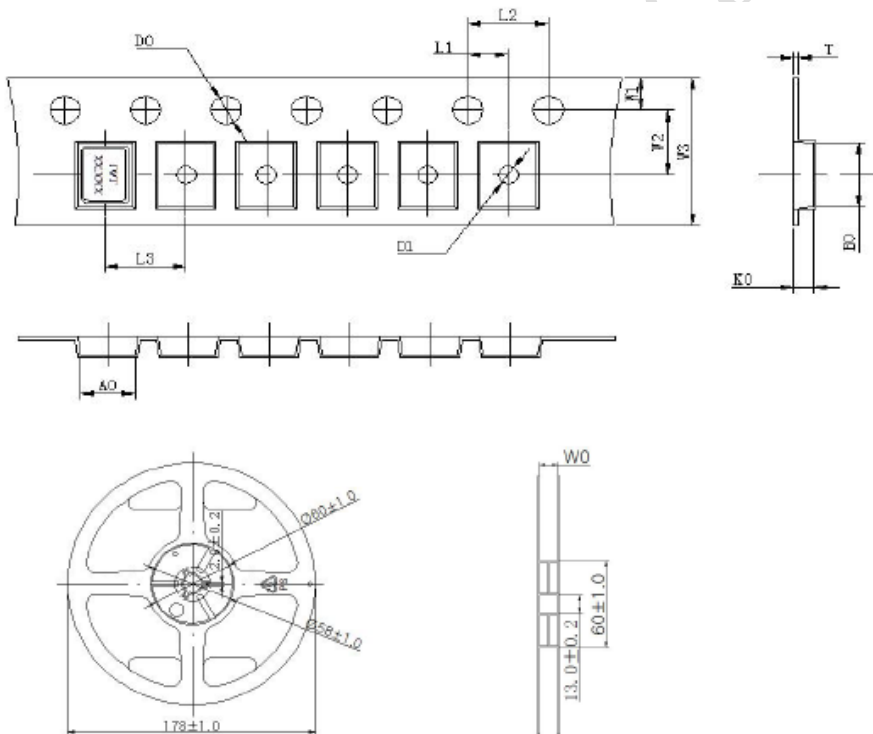

L1	2.00±0.1
L2	4.00±0.1
L3	4.00±0.1
D0	1.50±0.1
D1	1.00±0.1
W0	8.30±0.2
W1	1.75±0.1
W2	3.50±0.1
W3	8.00±0.1
A0	2.72±0.1
B0	3.46±0.1
K0	1.00±0.1
T	0.25±0.05