



DP2669C

ENG PART:DP-7.2CM-3900T4100-CW

3900MHz to 4100MHz Single-Junction Surface Mount Circulator

REV.	DESCRIPTION	REVISOR	DATE	APPROVED
1	Creating datasheet	ZC.Wu	2023/6/28	Nick

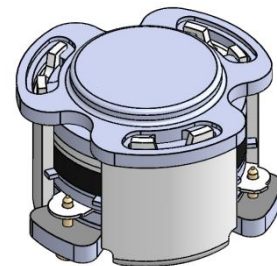

Applications:

- Wireless Infrastructure
- Power Amplifier

Features:

- Operating frequency range: 3900MHz to 4100MHz
- Operating temperature range: -40°C to +110°C
- Storage temperature range: -40°C to +125°C
- Small surface-mount package delivered on T&R
- BeOfree&RoHS compliant

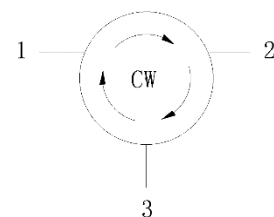

Block Diagram



Electrical Specifications:

ITEM	SPECIFICATION	
Frequency	3900-4100	MHz
Direction	CW	
Impedance	Typ: 50	Ω
Insertion Loss (Max.)	0.30	dB
Isolation (Min.)	20	dB
Return Loss (Min.)	22	dB
3rd IMD (Max.)	-60@2x10W 1, 5, 20, 100, 200MHz spacing	dBc
5th IMD (Max.)	-65@2x10W 1, 5, 20, 100, 200MHz spacing	dBc
Harmonics	60@ 2 x TX (20W CW) 60@ 3 x TX (20W CW)	dBc
Attenuation	20@2xTX 10@3xTX 5@nxTX	dB
Group delay	0.4~2.0	ns
Reciprocity	-0.05~+0.05 @Delta(S21 / S32) within any 10 °C temperature range	dB
	-1~+1 @Delta(S21 / S32) within any 10 °C temperature range	Deg
Power FWD/REV/PEAK	30/30/150	W
Input Impedance (Real)	/	Ω
Input Impedance (Imaginary)	/	Ω
Output Impedance	/	Ω
Resonance out of	3700~4300	MHz
Termination/Attenuator	/-	W/dB

Notes:

1. Exposure to maximum rating conditions for extended periods may reduce device reliability. There is no damage to device with only one parameter set at the limit and all other parameters set at or below their nominal value. Exceeding any of the limits listed here may result in permanent damage to the device.
2. Performance is guaranteed under the conditions listed in this table and over the operating temperature range.



Mechanical Specifications:

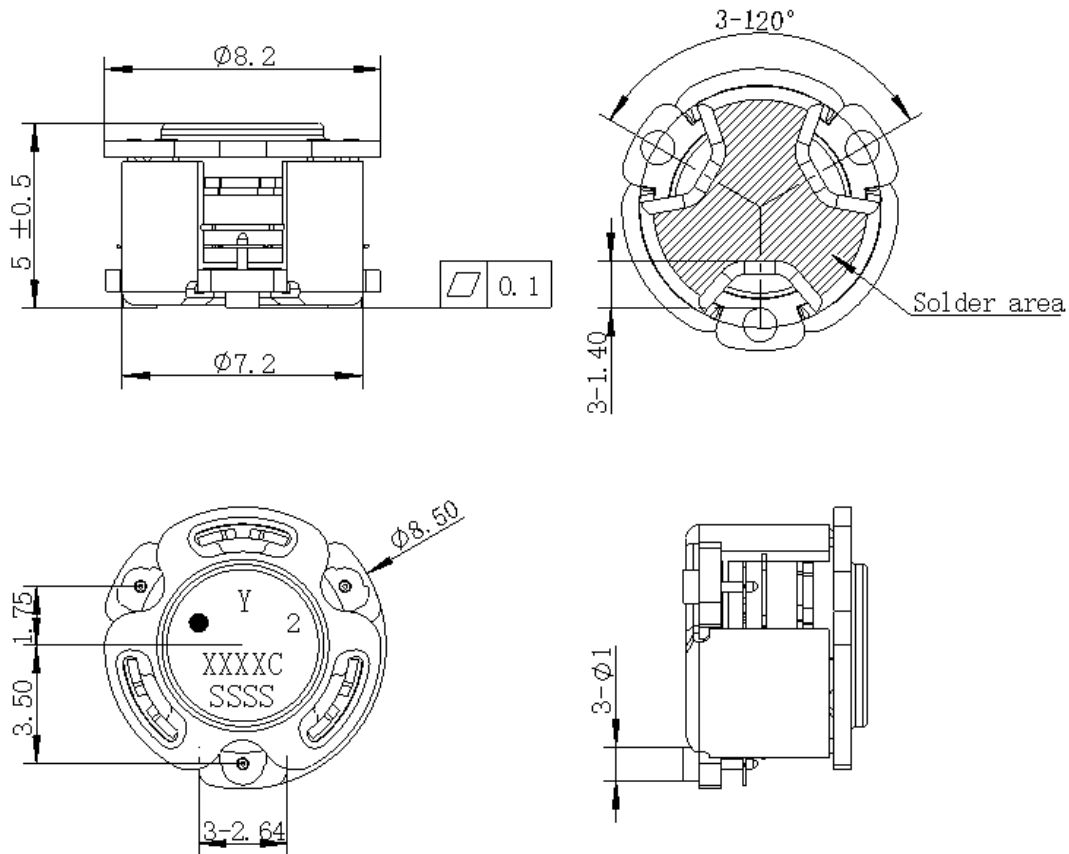

Unit: Millimeters

Notes:

1. The housing and pins are silver-plated.
2. Tolerance ± 0.2 mm unless otherwise specified.
3. Co-planarity Specification: 0.1mm maximum.
4. Part Number, Lot Code, and Port Designation are printed on the top side of device
5. The "Y" show on the label represents the producing year, when printing the producing year, A stands for 2022, B for 2023, C for 2024, and so on (reference DP's file WDPT PD-003).
6. The **XXXXC** on the label represents the last five digits of the Part Number.
7. The SSSS on the label represents the serial number
8. The black dot on the label represents the input port



Packaging Style:

ITEM	W	A0	B0	C0	K0	D	E	F	F2	P	P0	P2	T
DIM	32	Φ7.4	9.2	2.7	6.0	Φ1.5	1.75	14.2	28.4	20	4	2	0.5
TOLE	±0.2	±0.2	±0.2	±0.2	±0.2	+0.1	±0.1	±0.15	±0.1	±0.1	±0.1	±0.1	±0.05

