

Customer Code: _____

DATASHEET

DAPU P/N: DPZ2225M000018AA

DAPU			Customer Approval
Drew	Audited	Approved	Stamp, please! Thanks!
Jack	David	William	
Date: 2021.07.10			

Guangdong Dapu Telecom Technology Co.,Ltd

Building 5, No.24, Industrial East Road, Songshanhu Park, Dongguan, Guangdong, P.R. China

TEL: 0086-0769-88010888 FAX: 0086-0769-81800098



1、 Electrical Parameters

MODEL: DPZ2225M000018AA							
For Automotive							
No.	Parameters	SYM.	Electrical Spec.				Notes
			Min.	Typ.	Max.	Units	
1	Standard	-	Conforms to AEC-Q200				
2	Nominal Frequency	FL	25.00			MHz	
3	Oscillation Mode	-	Fundamental				
4	Frequency Tolerance	-	-10		+ 10	$\times 10^{-6}$	At 25°C
5	Frequency Stability	-	-25		+ 25	$\times 10^{-6}$	Over Operating Temperature Range
6	Operating Temperature	Topr	-40	~	+ 105	°C	
7	Storage Temperature	Tstg	-55	~	+ 125	°C	
8	Supply Voltage	V _{DD}	1.62	1.8	1.98	V	
9	Input Current	I _{cc}			10	mA	
10	Output waveform	-	CMOS				
11	Output Load	CL	15			pF	
12	Output Voltage High	V _{OH}	90%			V _{DD}	
13	Output Voltage Low	V _{OL}			10%	V _{DD}	
14	Rise/Fall Time	Tr、 Tf			5	ns	
15	Aging	-	-3		+ 3	$\times 10^{-6}$	First Year at 25°C
16	Tri-State Output Enable	-	70%			V _{DD}	Pin 1, OE
17	Tri-State Output Disable	-			30%	V _{DD}	Pin 1, OE
18	Duty Cycle	-	45	~	55	%	
19	Start-Up Time	Tstart			3	ms	Measured from the time V _{DD} reaches its rated minimum value



2、 Mechanical Structure(mm)

2.1 Dimensions

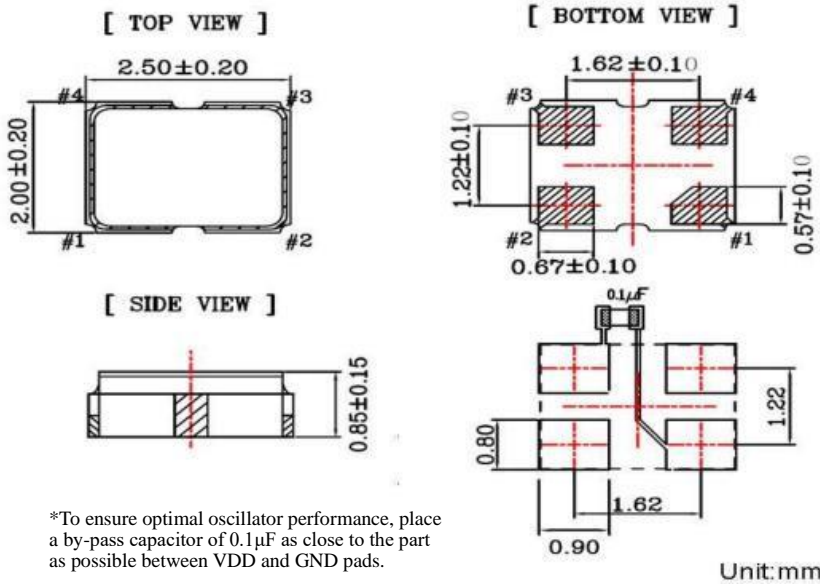

*To ensure optimal oscillator performance, place a by-pass capacitor of 0.1µF as close to the part as possible between VDD and GND pads.

Pin	Function
#1	Tri-State
#2	GND
#3	Output
#4	VDD

Unit:mm

2.2 Marking

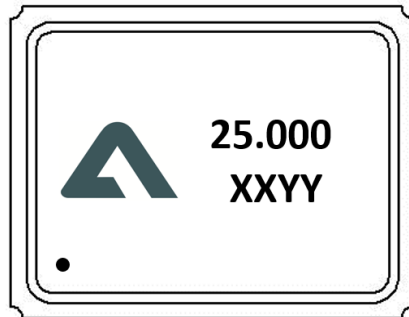

----- DAPU LOGO

25.000 ----- Frequency

XXYY ----- Manufactured day: XX YY
Year Week

• ----- Pin 1



3、 Test Circuit

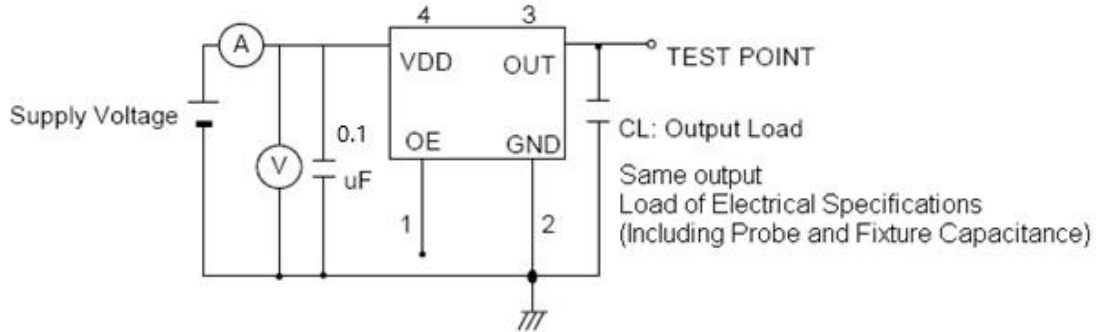

Control input (output enable/disable)

Logic 1 or open on pad 1: Oscillator output

Logic 0 on pad 1 : Disable output to high impedance

4、 Reflow Soldering Curve (RoHS)

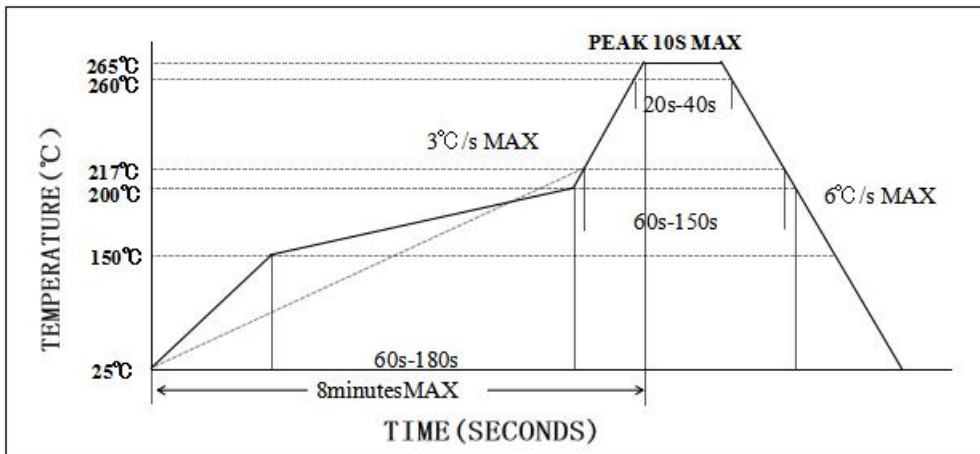



5、Package: Tape & Reel (mm)

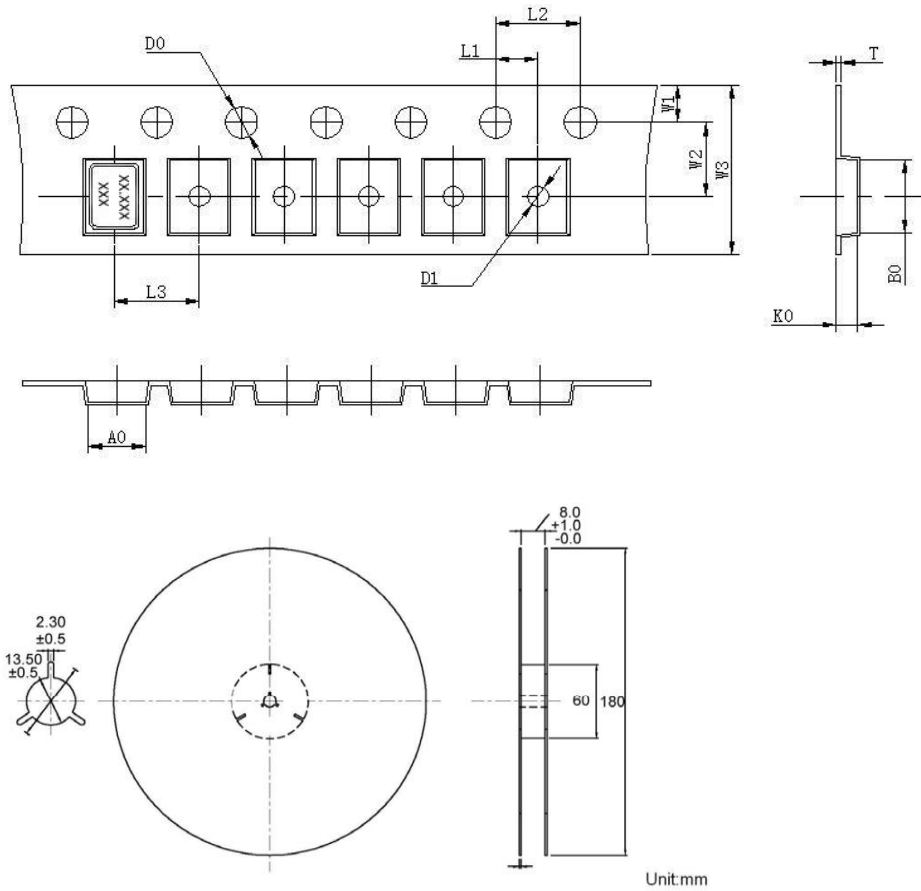

L1	2.00±0.1
L2	4.00±0.1
L3	4.00±0.1
D0	1.55±0.05
D1	1.20±0.5
W1	1.75±0.1
W2	3.50±0.1
W3	8.00±0.2
A0	2.25±0.1
B0	2.7±0.1
K0	1.45±0.1
T	0.25±0.05

6、Reliability Test Specification

6.1 Reliability Test (Reference AEC-Q200)

NO.	Test Items	Test Standard	Test Condition	Standard
1	High temperature storage	MIL-STD-202 Method 108	The crystal was placed at a temperature of 125°C ± 2°C for 1000 hours.	A
2	Temperature cycle	JESD22 Method JA-104	Crystal do 1000 cycles according to the table below temperature. 	A
3	Temperature and humidity	MIL-STD-202 Method 103	The crystal is placed for 1000 hours at a temperature of 85°C ± 2°C and a humidity of 85% Time.	A
4	Life span	MIL-STD-202 Method 108	The crystal is placed at a temperature of 105°C ± 2°C for 1000 hours (applied rated VDD).	A
5	shock	MIL-STD-202 Method 213	shock method:half sine wave 100G Duration:6ms	A

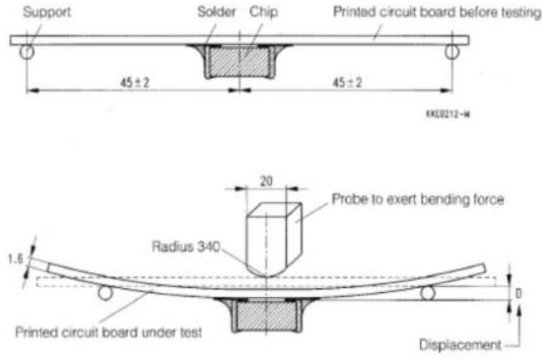
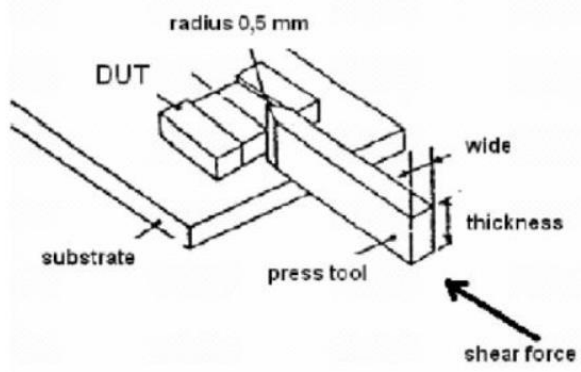

			Direction:X, Y, Z Axial, 6 faces, 18 shocks in total.	
6	Vibration	MIL-STD-202 Method 204	Vibration frequency:10~2000Hz Vibration amplitude:1.5mm Scan time:20 min Directions:X, Y, Z (12 cycles in each of the three directions)	A
7	Resistance to soldering heat	MIL-STD-202 Method 210	Reflow soldering: Peak temperature:260±5℃, time: 10s±1s.	A
8	Solderability	J-STD-002	Soldering temperature:245℃±5℃ Immersion time:5 seconds ± 0.5 seconds Flux:Rosin Resin Methanol Solvent (1 : 4)	B
9	Panel bending	AEC-Q200-005	Apply pressure to the center of the product until it bends to a minimum of 2mm and keep 60±5 seconds. 	A
10	Terminal strength	AEC-Q200-006	Apply a force of 1.8Kg laterally for 60±1 seconds. 	A

6.2 Test judgment

Specification	
A	Test after 24±2 hours under normal temperature and normal humidity, and meet Electrical performance requirements.
B	At least 95% of the immersed end is covered with new welding material.