

Customer Code: _____

DATASHEET

DAPU P/N: DPX2225M000008A1

DAPU			Customer Approval
Drew	Audited	Approved	Stamp, please! Thanks!
Jack	David	William	
Date: 2022.11.08			

Guangdong Dapu Telecom Technology Co.,Ltd

Building 5, No.24, Industrial East Road, Songshanhu Park, Dongguan, Guangdong, P.R. China

TEL: 0086-0769-88010888 FAX: 0086-0769-81800098



1、Electrical Parameters

MODEL: DPX2225M000008A1							
No.	Parameters	SYM.	Electrical Spec.				Notes
			Min.	Typ.	Max.	Units	
1	Nominal Frequency	FL	25.00			MHz	
2	Oscillation Mode	-	Fundamental				
3	Load Capacitance	CL	8			pF	
4	Frequency Tolerance	-	-20		+20	$\times 10^{-6}$	At 25°C
5	Frequency Stability	-	-30		+30	$\times 10^{-6}$	Over Operating Temperature Range (Reference 25°C)
6	Operating Temperature	Topr	-40	~	+105	°C	
7	Storage Temperature	Tstg	-55		+125	°C	
8	Drive Level	DL	1	100	200	μ W	
9	Equivalent Series Resistance	ESR			80	Ω	
10	Shunt Capacitance	-			3.0	pF	
11	Insulation Resistance	IR	500			M Ω	At DC 100V
12	Aging	-	-3		+3	$\times 10^{-6}$	First year at 25°C



2、Mechanical Structure(mm)

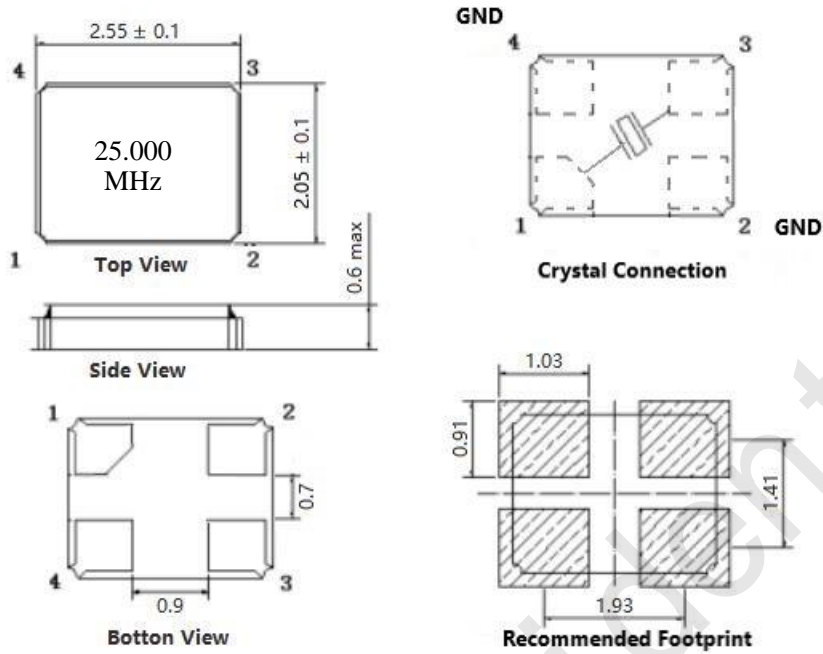

3、Reflow Soldering Curve(RoHS)

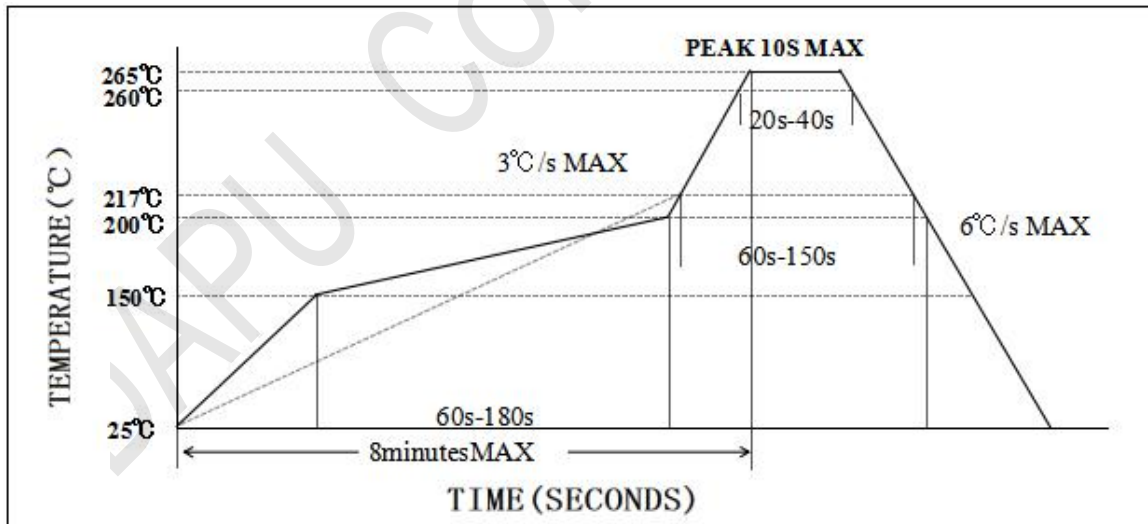



4、 Package: Tape & Reel (mm)

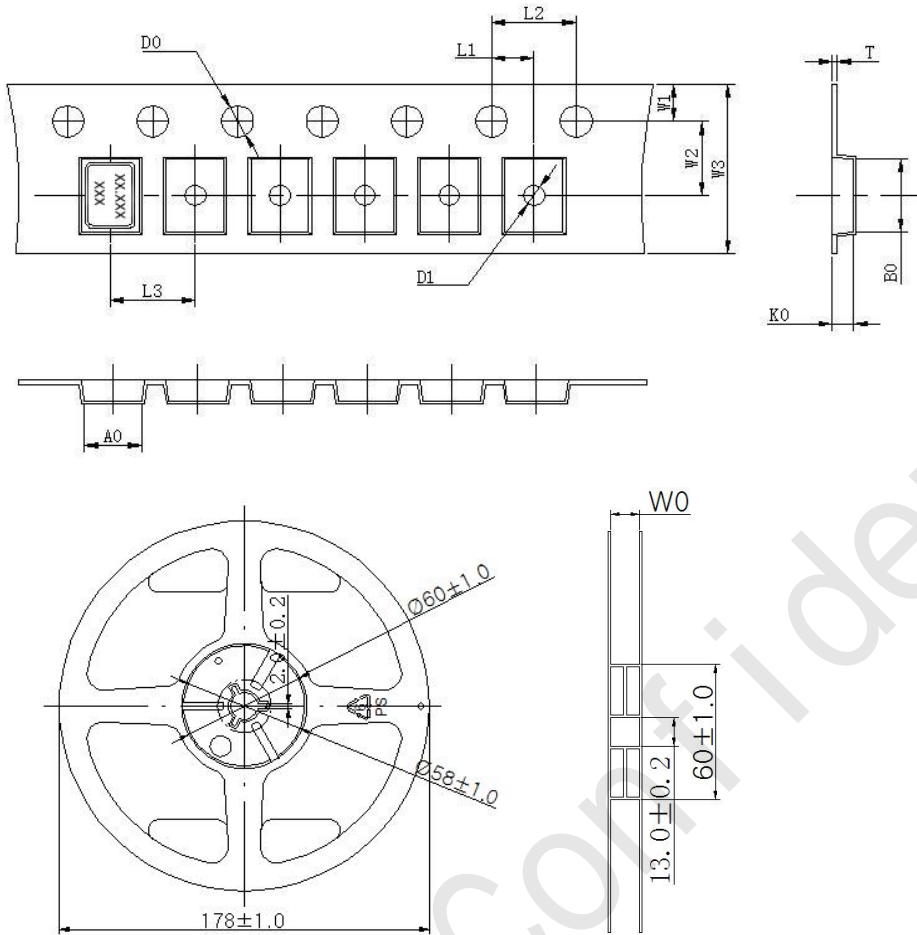

L1	2.00±0.1
L2	4.00±0.1
L3	4.00±0.1
D0	1.50±0.1
D1	1.00±0.1
W0	8.50±0.2
W1	1.75±0.1
W2	3.50±0.1
W3	8.00±0.1
A0	2.25±0.1
B0	2.70±0.1
K0	0.80±0.1
T	0.25±0.05

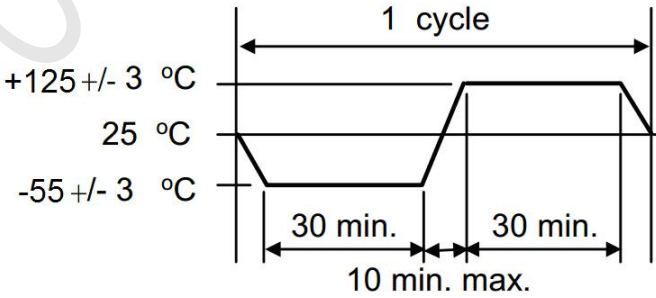

5、 Reliability Test Specification

NO.	Test Items	Test Standard	Test Condition	Specifications
1	Drop test	GB/T2423.8	Drop from 150cm height on 3cm hard wooden board for 3 times.	Electrical performance meets specification requirements
2	Mechanical shock	GB/T2423.5	Peak: 100g; Waveform: Half-sine; Velocity Change: 1000m/s ² ; Duration: 0.5ms; 3 times/direction, Direction: +X, -X, +Y, -Y, +Z, -Z.	
3	Vibration	GB/T2423.10	Frequency: 10~2000Hz; Vibration:20min, 1.52mm; Direction: X, Y, Z; Duration: 2 hours/direction.	
4	Solderability	IEC60068-2-58	Solder bath temperature:245±5°C; Dwell time:3±0.5 seconds; Solder: 100% tin.	
5	Resistance to soldering heat	IEC60068-2-58	Solder temperature 260±5°C; Immersion time:10±1S; Solder bath composition:100% tin.	
6	High temperature storage	GB/T2423.2	Temperature: 125°C±2°C; Duration: 500±12hours.	
7	Low temperature storage	GB/T2423.1	Temperature: -40°C±2°C; Duration: 500±12hours.	
8	Temperature Shock	GB/T2423.22	Do 10 cycles at the following temperature 	
9	High temperature high humidity storage	GB/T2423.3	Temperature: 85°C±3°C; Humidity: 85%; Duration: 500hours.	