



DSO3001 —High Performance All-silicon Oscillator

Key Features

- All-silicon without quartz and MEMS
- Total frequency stability : ± 50 ppm
- Single ended output: 10 kHz ~ 212.5MHz
- Differential output: 10 kHz ~ 350 MHz
- Operating temperature : $-40^{\circ}\text{C} \sim 85^{\circ}\text{C}$
- Power supply: 1.8V/2.5V/3.3V
- Output: LVDS, LVPECL, HCSL, CML, LVCMOS or dual LVCMOS
- Package: 3225 and 5032
- Low jitter: 350 fs Typ RMS (12 kHz – 20 MHz bandwidth)
- Built-in LDO and power filter circuit
- RoHS Compliant

Application

- Automotive electronics
- Intelligent terminal
- Ethernet
- Consumer electronics
- Communication equipment

Block Diagram

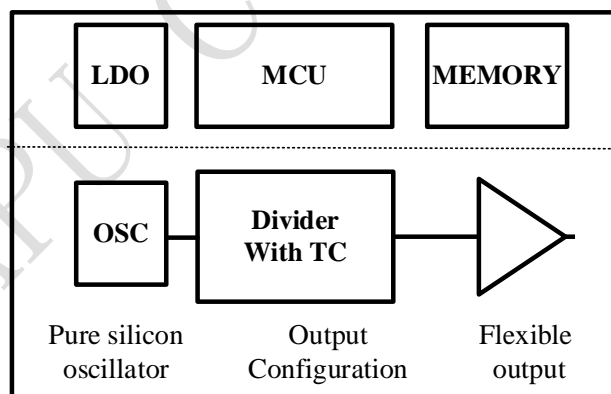

Overview

Dapu all silicon oscillator adopts unique frequency synthesis and sensor technology, which can output any clock from 10 kHz to 350 MHz without quartz and MEMS devices. The product can keep low jitter and frequency stability in the whole working range, and has high reliability in harsh environment and strong vibration.



Revision History

Version	Change Contents	Prepared by	Revised Date
V1.0.0	First Issued	David	2021.05.08
V1.0.1	Update 7.2 Dimension (3225)	Lin	2022.02.15
V1.1.1	Update Table 6.1 MSL	Lin	2022.04.16
V1.1.2	Update 7.4 Marking and 7.2 Dimension (3225)	Lin	2022.07.06

DAPU P/N: DSO3001-32A-LD1D-4M666000

Customer P/N: _____



Index

1	OVERVIEW	4
2	BLOCK DIAGRAM	4
3	FEATURES	4
4	PIN DEFINITION	5
5	ELECTRICAL SPECIFICATIONS	5
6	ENVIRONMENTAL CONDITIONS	8
7	DIMENSION AND PACKAGE.....	8
7.1	DIMENSION (5032)	8
7.2	DIMENSION (3225).....	9
7.3	PCB	10
7.4	MARKING	10
8	ORDERING GUIDE	11
9	APPENDIX	12
	RECOMMENDED OUTPUT TERMINATIONS	12
	CMOS.....	12
	LVPECL	12
	LVDS/CML	13
	HCSL.....	13



1 Overview

DSO3001 series all silicon oscillator is a clock free oscillator without quartz and MEMS devices. It is a high reliable clock oscillator which can still work normally under harsh environment and strong vibration. The chips can be manufactured to achieve multi-frequency and multi-format output from 10KHz to 350MHz, and maintain low jitter and frequency stability throughout the operation range.



Thanks to the built-in temperature and stress sensors, the DSO3001 all silicon oscillator can adapt to the harsh working environment. The built-in LDO and filter circuit greatly enhance the power supply noise suppression ability of the chip. Flexible clock frequency configuration and output format configuration provide maximum convenience for customer product design.

2 Block Diagram

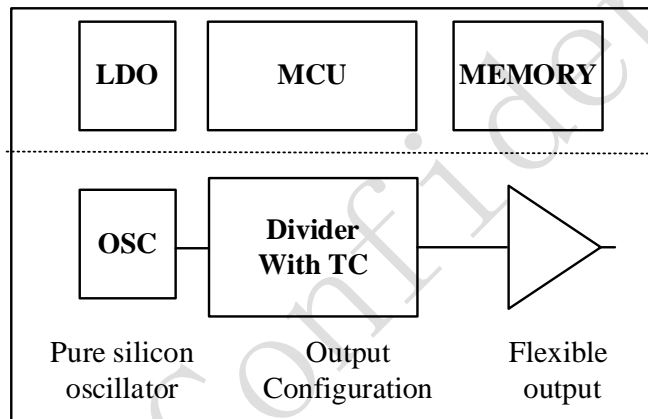

3 Features

- All-silicon without quartz and MEMS
- Total frequency stability: ± 50 ppm
- Single ended output: 10 kHz ~ 212.5MHz
- Differential output: 10 kHz ~ 350 MHz
- Operating temperature: $-40^{\circ}\text{C} \sim 85^{\circ}\text{C}$
- Power supply: 1.8V/2.5V/3.3V
- Output: LVDS, LVPECL, HCSL, CML, LVCMOS or dual LVCMOS
- Package: 3225 and 5032
- Low jitter: 350 fs Typ RMS (12 kHz – 20 MHz bandwidth)
- Built-in LDO and power filter circuit
- RoHS Compliant



4 Pin Definition

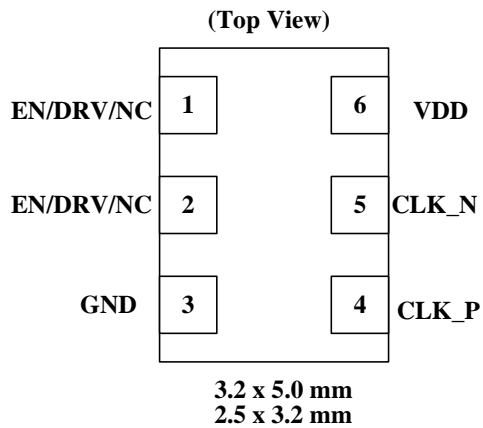

PIN	Description
1	Optional function EN = Output Enable, active high DRV = Output Driver Enable, active high NC = Not Connect
2	Optional function (refer to PIN1)
3	GND
4	CLK_P
5	CLK_N
6	VDD

5 Electrical Specifications

Table 5.1 Absolute Maximum Ratings¹

Parameter	Symbol	Rating	Unit
Operating Temperature	T _A	-40 to 85	°C
Storage Temperature	T _S	-55 to 105	°C
Supply Voltage	V _{DD}	-0.5 to 3.8	V
Input Voltage	V _{IN}	-0.5 to V _{DD} + 0.3	V
ESD HBM (JESD22-A114)	HBM	4.0	kV
Solder Temperature ²	T _{PEAK}	260	°C
Solder Time at T _{PEAK} ²	T _P	20 - 40	sec

Notes:

1. Stresses beyond those listed in this table may cause permanent damage to the device. Functional operation specification compliance is not implied at these conditions. Exposure to maximum rating conditions for extended periods may affect device reliability.

2. The device is compliant with JEDEC J-STD-020.

Table 5.2 Recommended Operating Conditions

Parameter	Symbol	Min	Typ	Max	Unit	Test Condition/Comment
Supply Voltage	V _{DD}	1.71	1.8	1.89	V	V _{DD} = 1.8 V
		2.375	2.5	2.625	V	V _{DD} = 2.5 V
		3.135	3.3	3.47	V	V _{DD} = 3.3 V
Supply Current (F _{CLK} = 50 MHz)	I _{DD}		40	50	mA	Tristate Hi-Z (EN = 0, output disabled)
			1	2	mA	Ready State



						(DRV = 0, standby mode)
			70	80	mA	LVPECL (DC-Coupled)
			60	70	mA	LVPECL (AC-Coupled)
			45	55	mA	LVDS
			60	70	mA	HCSL
			60	70	mA	CML
			40	55	mA	CMOS
			50	60	mA	Dual CMOS
Operating Temperature	TA	-40		85	°C	

Table5.3 Input Electrical Specifications

Parameter	Symbol	Min	Typ	Max	Unit	Test Condition/Comment
Output Enable (EN) ¹	V _{IH}	0.7×V _{DD}			V	
	V _{IL}			0.3×V _{DD}	V	
	T _D			3	μs	Output Disable Time, F _{CLK} >10 MHz
	T _E			20	μs	Output Enable Time, F _{CLK} >10 MHz
Output Enable (DRV) ¹	V _{IH} '	0.7×V _{DD}			V	
	V _{IL} '			0.3×V _{DD}	V	
	T _D '			3	μs	Output Disable Time. Within 40us, the current drops to less than 1.5mA F _{CLK} >10 MHz
	T _E '			400	μs	Output Enable Time, F _{CLK} >10 MHz

Notes:

1. EN/DRV includes a 50 kΩ pull-up to V_{DD} for EN active high. Includes a 50 kΩ pull-down to GND for EN/DRV active low. NC (No Connect) pins include a 50 kΩ pull-down to GND.

Table 5.4 Output Electrical Specifications

Parameter	Symbol	Min	Typ	Max	Unit	Test Condition/Comment
Frequency Range	F _{CLK}	0.01		350	MHz	LVDS, LVPECL, CML, HCSL
		0.01		212.5	MHz	CMOS, Dual CMOS
Total Stability ¹	F _{STAB}	-50		50	ppm	Frequency stability
Rise/Fall Time (20% to 80% V _{PP})	T _R /T _F			350	ps	LVPECL/LVDS/CML
			0.5	1.5	ns	CMOS / Dual CMOS (C _L = 5 pF)
				550	ps	HCSL, F _{CLK} >50 MHz
Powerup Time	t _{OSC}			4	ms	Time from 0.9 × V _{DD} until output frequency (F _{CLK}) within spec
Duty Cycle	DC	45		55	%	
LVPECL Output Option ² (DC-Coupled)	V _{OC}	V _{DD} -1.55		V _{DD} -1.25	V	Mid-level
	V _O	1.4		1.85	V _{PP}	Swing (diff ⁶)
LVPECL Output Option ²	V _O	1.4		1.85	V _{PP}	Swing (diff ⁶)



(AC-Coupled)						
LVDS Output Option ³ (DC-Coupled)	V _{OC}	1.125	1.20	1.275	V	Mid-level (2.5 V, 3.3 V V _{DD})
		0.795	0.85	0.905	V	Mid-level (1.8 V V _{DD})
	V _O	0.5	0.82	0.96	V _{PP}	Swing (diff ⁶)
	V _{OL}	0	5	10	mV	Output voltage low
HCSL Output Option ⁴ (R _{term} = 50 Ω; DC-Coupled)	V _{OH}	695	815	935	mV	Output voltage high
HCSL Output Option ⁵ (R _{term} = 42.5 Ω; DC-Coupled)	V _{OH}	695	820	945	mV	Output voltage high
	V _{OL}	0	5	10	mV	Output voltage low
CML Output Option (AC-Coupled)	V _O	0.725	0.8	0.89	V _{PP}	Swing (diff ⁶)
CMOS Output Option	V _{OH}	0.83×V _{DD}			V	I _{OH} = 8/6/4 mA for 3.3/2.5/1.8V V _{DD}
	V _{OL}			0.17×V _{DD}	V	I _{OL} = 8/6/4 mA for 3.3/2.5/1.8V V _{DD}

Notes:

1. Total Stability, includes temperature stability, initial accuracy, load pulling, V_{DD} variation, and aging for 10 years at 40°C.
2. R_{term} = 50 Ω to V_{DD} – 2.0 V (Refer to Appendix figure3).
3. R_{term} = 100 Ω (differential) (Refer to Appendix figure4)
4. R_{term} = 50 Ω to GND (Refer to Appendix figure5).
5. R_{term} = 42.5 Ω to GND (Refer to Appendix figure5).
6. “diff” means differential signal

Table 5.5 Clock Output Phase Jitter and PSRR

Parameter	Symbol	Min	Typ	Max	Unit	Test Condition/Comment
Phase Jitter (RMS, 12 kHz - 20 MHz) ^{1,2} F _{CLK} ≥ 10 MHz	φ _J		350	750	fs	Differential Formats
			350		fs	CMOS, Dual CMOS
Phase Jitter (RMS, 50 kHz - 20 MHz) F _{CLK} ≥ 156.25 MHz	φ _J		150	250	fs	Differential Formats
			100		fs	CMOS, Dual CMOS
Spurs Induced by External Power Supply Noise, 50 mV _{pp} Ripple. LVDS 156.25 MHz Output V _{DD} = 1.8 V	PSRR		-76		dBc	100 kHz sine wave
			-75			200 kHz sine wave
			-75			500 kHz sine wave
			-75			1 MHz sine wave
Spurs Induced by External Power Supply Noise, 50 mV _{pp} Ripple. LVDS 156.25 MHz Output V _{DD} = 2.5 or 3.3 V	PSRR		-83		dBc	100 kHz sine wave
			-83			200 kHz sine wave
			-83			500 kHz sine wave
			-82			1 MHz sine wave

Notes:

1. Applies to output frequency: 50, 100, 156.25, 212.5, 350 MHz.
2. Guaranteed by characterization. Jitter inclusive of any spurs.



6 Environmental Conditions

Table 6.1. Environmental Conditions

Package	Symbol	Parameter	Test Condition	Value	Unit
	MSL	Moisture Sensitivity Level	2		
5032 6-pin DFN	Θ_{JA}	Thermal Resistance Junction to Ambient	Still Air	105	°C/W
	Θ_{JB}	Thermal Resistance Junction to Board	Still Air	81	°C/W
	T_J	Max Junction Temperature	Still Air	125	°C
3225 6-pin DFN	Θ_{JA}	Thermal Resistance Junction to Ambient	Still Air	108	°C/W
	Θ_{JB}	Thermal Resistance Junction to Board	Still Air	84	°C/W
	T_J	Max Junction Temperature	Still Air	125	°C

7 Dimension and Package

7.1 Dimension (5032)

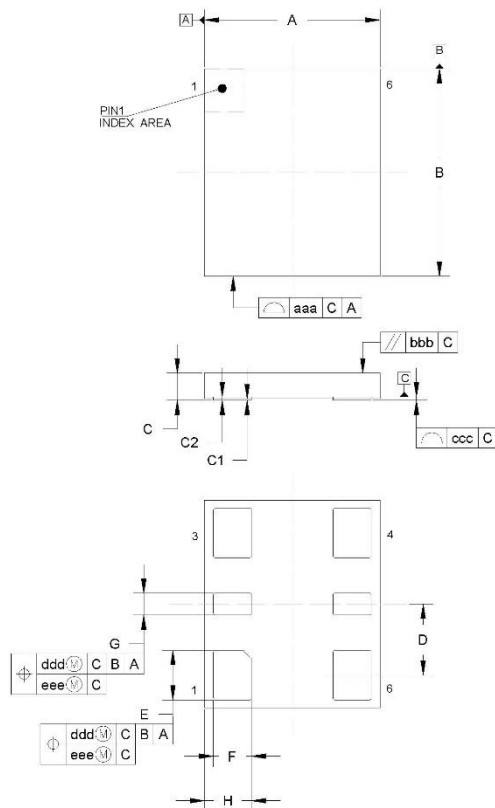

Table 7.1. Package Diagram Dimensions (mm)

Dimension	Min	Nom	Max
A		3.2 BSC	
B		4 BSC	
C	0.8	0.85	0.9
C1	0	0.035	0.05
C2		0.203 REF	
D		1.27 BSC	
E	0.59	0.64	0.69
F	0.7	0.75	0.8
G	0.59	0.64	0.69
H		0.85 REF	
aaa		0.1	
bbb		0.1	
ccc		0.08	
ddd		0.1	
eee		0.1	

Figure 7.1. DSO3001 (5032) Outline Diagram



Notes:

1. All dimensions shown are in millimeters (mm) unless otherwise noted.
2. Dimensioning and Tolerancing per ANSI Y14.5M-1994.

7.2 Dimension (3225)

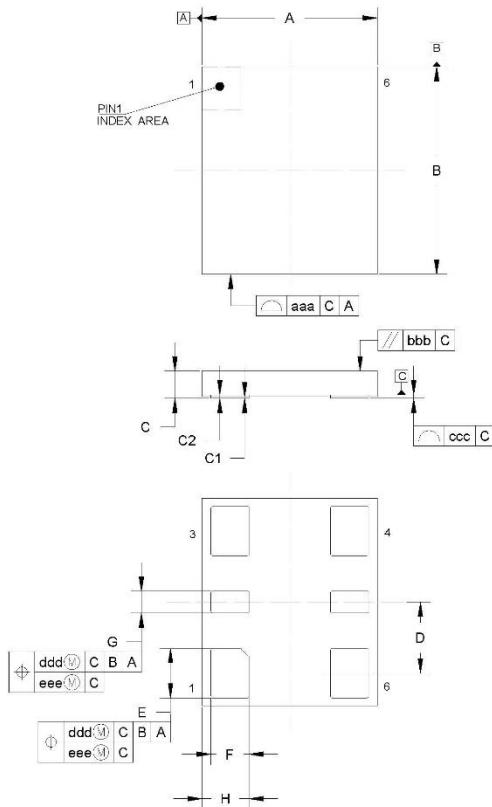

Table 7.2. Package Diagram Dimensions (mm)

Dimension	Min	Nom	Max
A		2.5 BSC	
B		3.2 BSC	
C	0.8	0.85	0.9
C1	0	0.035	0.05
C2		0.203 REF	
D		1.175 BSC	
E	0.6	0.65	0.7
F	0.65	0.7	0.75
G	0.45	0.5	0.55
H		0.8 REF	
aaa		0.1	
bbb		0.1	
ccc		0.08	
ddd		0.1	
eee		0.05	

Figure 7.2. DSO3001 (3225) Outline Diagram

Notes:

1. The dimensions in parentheses are reference.
2. All dimensions in millimeters (mm).
3. Dimensioning and Tolerancing per ANSI Y14.5M-1994.

7.3 PCB

The figure below illustrates the PCB land pattern for the DSO3001. The table below lists the values for the dimensions shown in the illustration.

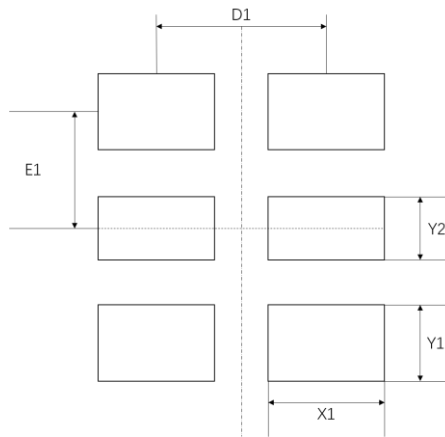

Figure 7.3. DSO3001 (5032 and 3225) PCB Land Pattern

Table 7.3. PCB Land Pattern Dimensions (mm)

Dimension	5032(mm)	3225(mm)
X1	0.80	0.75
Y1	0.69	0.7
Y2	0.69	0.55
D1	2.30	1.65
E1	1.27	1.175

7.4 Marking



Figure 7.4 DSO3001 Top Mark

Table 7.4 Top Mark Description



Line	Print	Description
1	DPDA01	DP means Dapu DA means out wave 01 means Internal code
2	4M6660	Frequency
3	YYWWA	YYWW means DATE A means Internal code

8 Ordering Guide

The naming rules and definitions of DSO3001 are as follows:

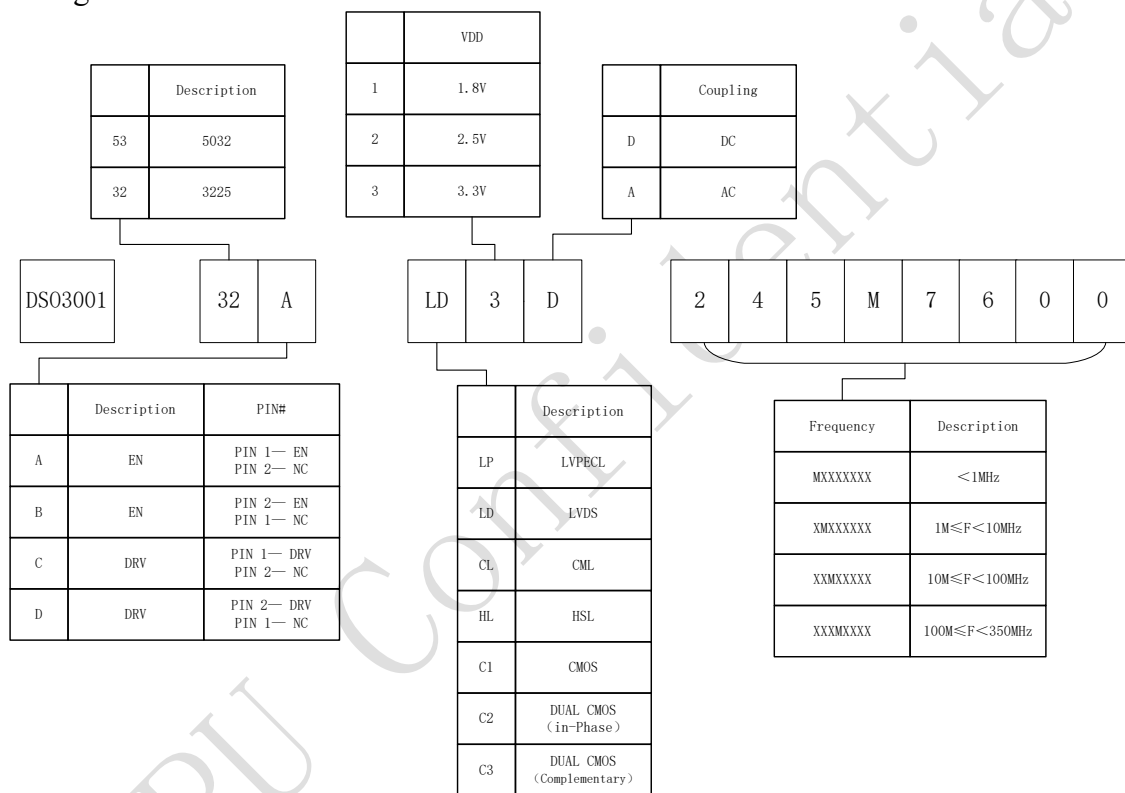

Notes:

- DSO3001-32A-LD3D-245M7600 means a silicon crystal with 3225 package, 1 pin defined as EN, input voltage 3.3V, output 245.76M DC-coupled LVDS signal.
- Recommended Signal Formats and Voltage Combinations

Signal Format	VDD	Coupling
LVPECL	2.5V/3.3V	DC/AC
LVDS	1.8V/2.5V/3.3V	DC
CML	1.8V/2.5V/3.3V	AC
HCSL(50 Ω termination)	1.8V/2.5V/3.3V	DC
HCSL(42.5 Ω termination)	1.8V/2.5V/3.3V	DC
CMOS/Dual CMOS	1.8V/2.5V/3.3V	DC

9 Appendix

Recommended Output Terminations

CMOS

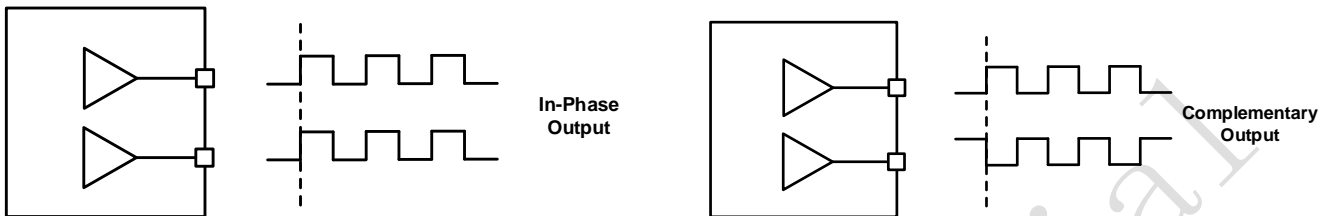

Figure 1 Dual CMOS Output

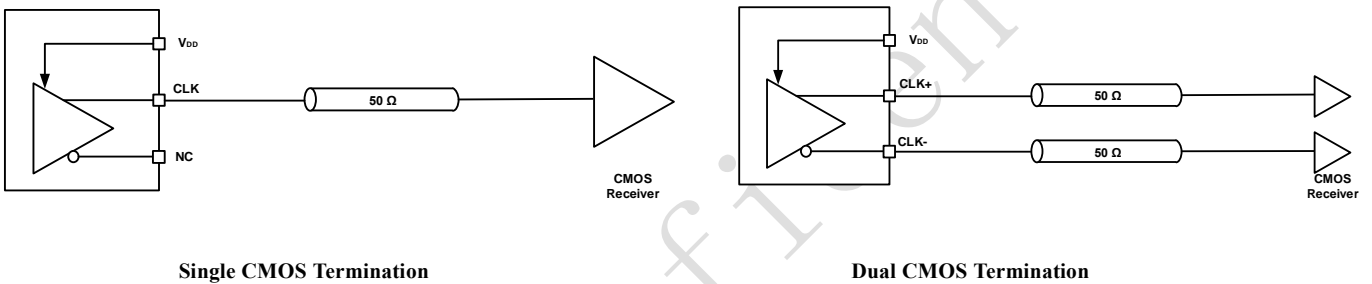
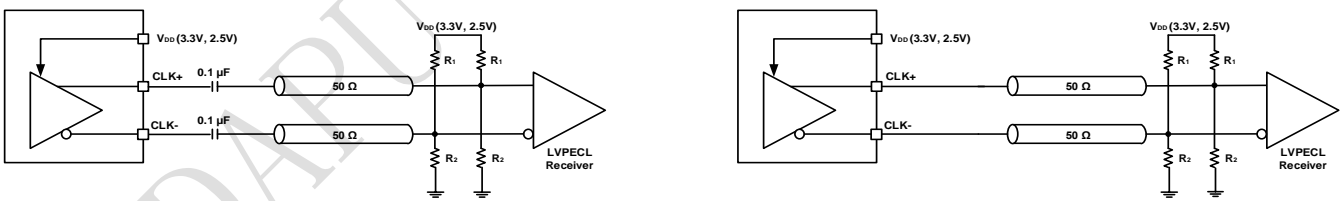

Figure 2. CMOS Output Termination

LVPECL

The output drivers support AC-coupled or DC-coupled terminations as shown in figures below.



AC-Coupled LVPECL – Thevenin Termination

DC-Coupled LVPECL – Thevenin Termination

Table 1. Termination Resistor Values

V _{DD}	R ₁	R ₂
3.3 V	127 Ω	82.5 Ω
2.5 V	250 Ω	62.5 Ω

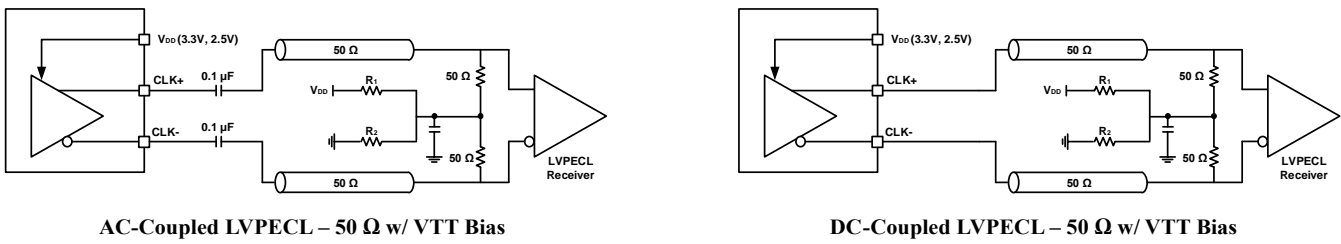

Figure 3. LVPECL Output Terminations

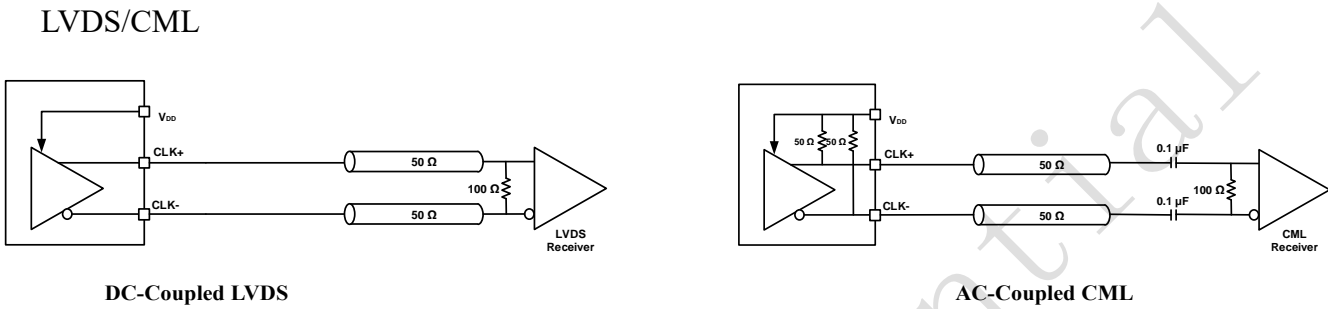

Figure 4. LVDS / CML Output Terminations

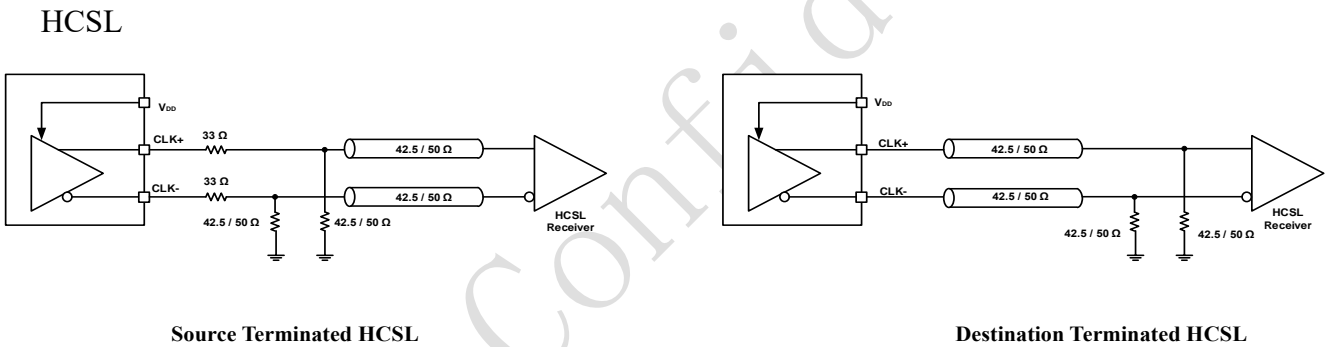

Figure 5. HCSL Output Terminations