

5mm SMD ISOLATOR

RF component

Datasheet Rev.: 1
Date: 2022.09.29

Customer:

Product Name:

DP-IL0520A742

DP-IL0520B742

Customer P/N:



GuangdongDapuTelecomTechnologyCo.,Ltd Building5, No.24, Gongye East Road,
<http://www.dptel.com> SSL Sci & Tech Industry Park,
Dongguan, Guangdong, China
TEL: 0086-0769-88010888
FAX: 0086-0769-81800098

Approved	Checked	Designer
Nick	Wison	ZC.Wu

5mm SMD ISOLATOR

RF component

Datasheet Rev.: 1
 Date: 2022.09.29

MECHANICAL SPECIFICATION

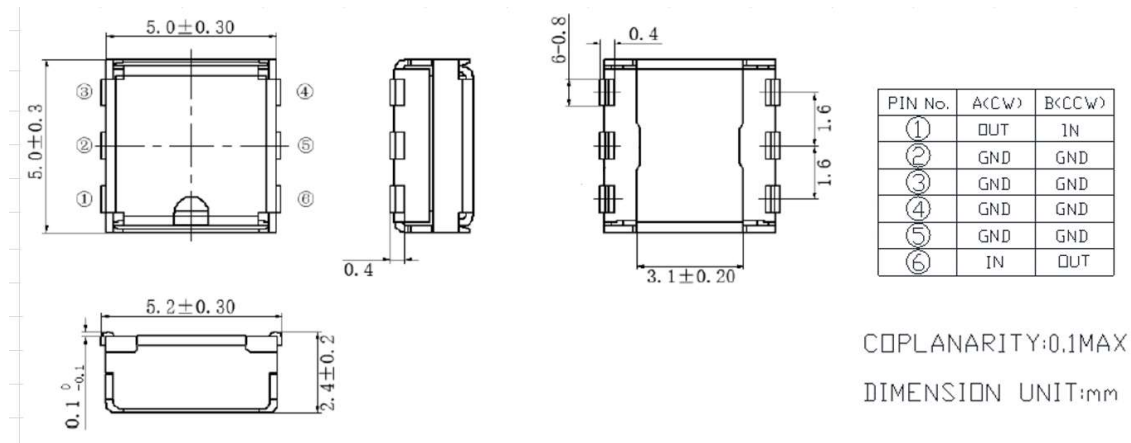

MARKING

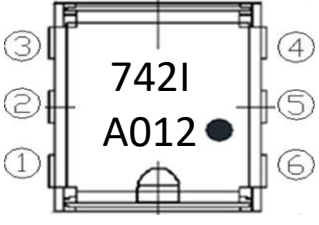
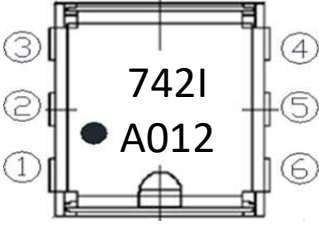
Clockwise	CounterClockwise	①/⑥ : Out/In Port ②~⑤: Ground 742: Central Frequency 742MHz I: Isolator A: Year 01: Week of Year 2: Day of Week ●: Input Port
DP-IL0520A742	DP-IL0520B742	
		

Year Code	
Year	Code
2019	A
2020	B
2021	C
2022	D
2023	E
2024	F
...	...

Week Code	
Week	Code
1	01
2	02
3	03
4	04
5	05
6	06
...	...

Day Code	
Day	Code
Monday	1
Tuesday	2
Wednesday	3
Thursday	4
Friday	5
Saturday	6
Sunday	7

5mm SMD ISOLATOR

RF component

Datasheet Rev.: 1
 Date: 2022.09.29

TEMPERATURE RANGE

Operating temperature range : -40~+85°C

Storage temperature range: -55~+125°C

ELECTRICAL CHARACTERISTICS

Parameter	Unit	Frequency (MHz)		DP Spec			
				Min.	Typ.	Max.	
Frequency range	MHz	728		757	728		757
Insertion Loss	dB	-		-			0.90
Isolation	dB	-		-	9		
Return Loss	dB	-		-	14		
Power Handling (Average)	W						5
Power Handling (Peak)	W						10
Reflection power	W						2
Characteristic Impedance (ohm)	Ω					50	
Case Style	-					SMD	

NOTES

1. Recommend to keep 30mm above when mounted with other magnetic products.
2. RoHS compliance.
3. Isolator's characteristics are guaranteed at conditions listed at above table and it's operating temperature range.

5mm SMD ISOLATOR

RF component

Datasheet Rev.: 1
 Date: 2022.09.29

RECOMMENDED LAND PATTERN

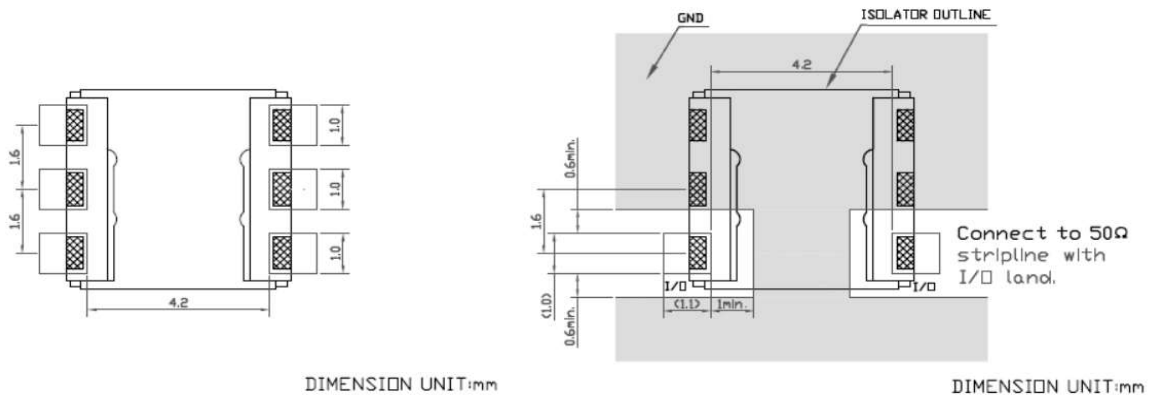

RECOMMENDED REFLOW PROFILE

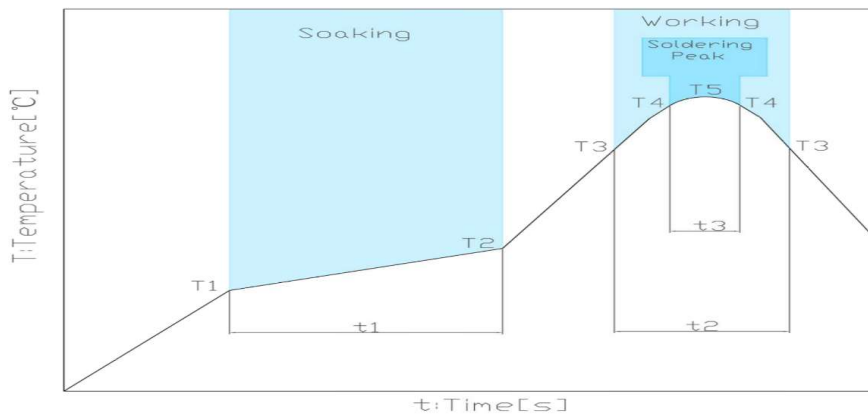

Soaking			Working		Soldering Peak		
Temp.	Time		Temp.	Time	Temp.	Time	Temp.
T1	T2	t1	T3	t2	T4	t3	T5
150°C	180°C	60 to 120s	230°C	30 to 60s	250°C	within 10s	260°C max.

5mm SMD ISOLATOR

RF component

Datasheet Rev.: 1
 Date: 2022.09.29

PACKING STYLE

REEL DIMENSIONS

Reel side \longrightarrow Pulling side

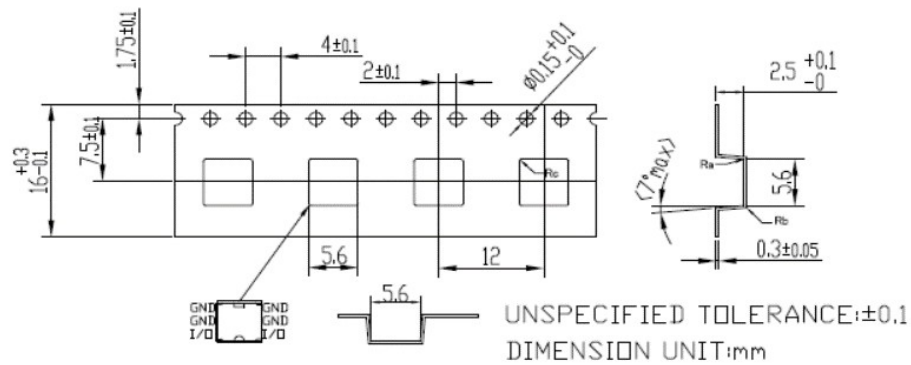

TAPE DIMENSIONS

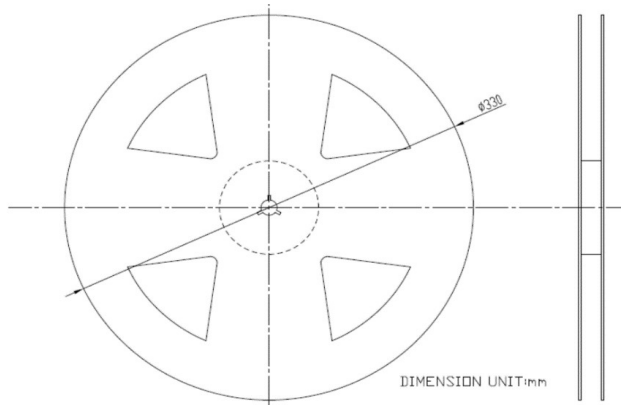

PACKAGE QUANTITY

2000 PCS/REEL

5mm SMD ISOLATOR

RF component

Datasheet Rev.: 1
Date: 2022.09.29

Revision Records

Rev.	Date	PIC	Change item	Reasons for change
1	2022.09.29	ZC.Wu	New regulations	
2				
3				
4				
5				
6				
7				
8				