

Travelling Merchant: \_\_\_\_\_

# DATASHEET

Standard:                   **DPAF32768006**                  

Plot			The Label
Drew	Audited	Approved	Stamp, please! Thanks!
Date: 2021.11.18			

## Guangdong Dapu Telecom Technology Co.,LTD

Building 5, No.24, Industrial Road East, Songshanhu Park, Dongguan, Guangdong, P.R. China

TEL: 0086-0769-88010888 FAX: 0086-0769-81800098



## 1、 Electrical Parameters

MODEL: DPAF32768006							
No.	Parameters	SYM.	Electrical Spec.				Notes
			Min.	Typ.	Max.	Units	
1	Nominal Frequency	FL	32.768			KHz	
2	Oscillation Mode	-	Fundamental			-	
3	Load Capacitance	CL	12.5			pF	
4	Frequency Tolerance	-	-20	~	+20	$\times 10^{-6}$	at 25°C± 3°C
5	Parabolic Coefficient	-	-0.04	4	-0.02	PPM/°C <sup>2</sup>	
6	Operating Temperature	-	-40	~	+125	°C	
7	Storage Temperature Range	-	-40	~	+125	°C	
8	Aging	-	-3	~	+3	$\times 10^{-6}$	Per year
9	Drive Level	DL	-	0.1	0.5	uW	
10	Equivalent Series Resistance	Rr	-	-	80	KΩ	
11	Shunt Capacitance C0	C0		1.2		pF	
12	Motional Capacitance	C1		4.8		fF	
13	Insulation Resistance	-	500	-	-	MΩ	at DC 100V
14	Quality Factor	Q	13			K	



## 2、Mechanical Structure(mm)

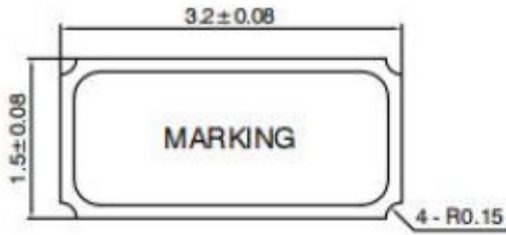

<Connection>

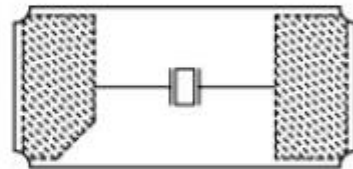

<Suggested Layout>

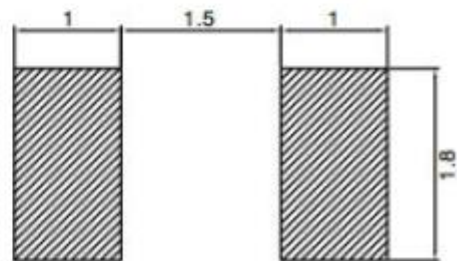
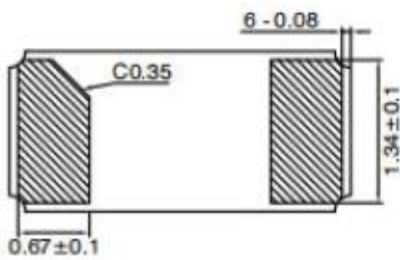



### 3、 Package: Tape & Reel (mm)

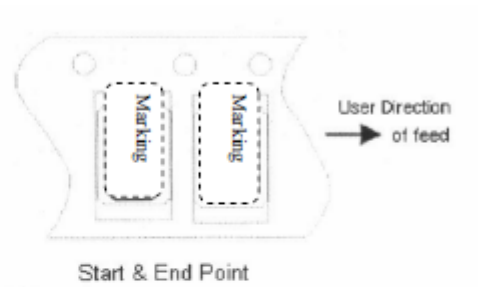
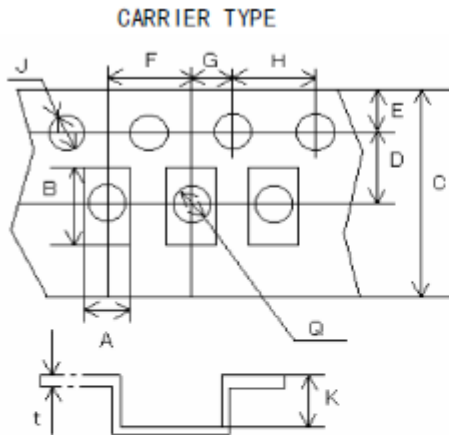

A	B	C	D	E	F	G	H	J	K	t
1.75	3.45	12.0	5.5	1.75	4.0	2.0	4.0	1.5	1.0	0.25

REMARK:

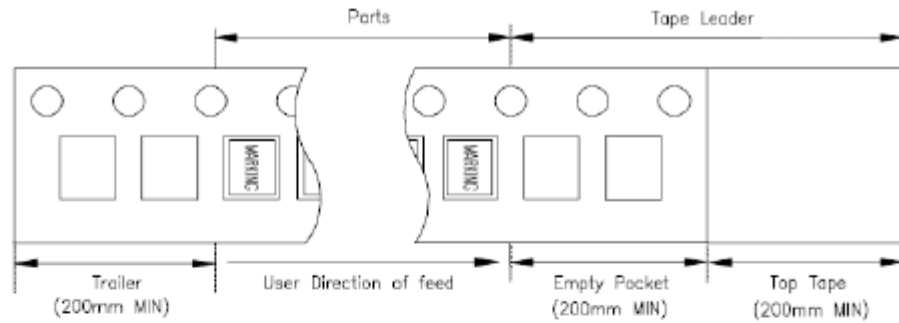

REEL: 3000 PCS/Reel

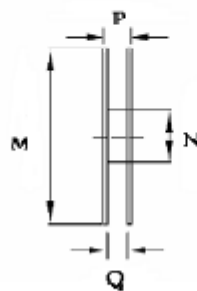
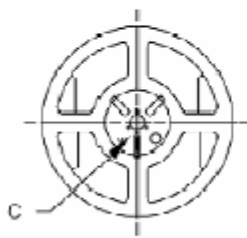

C. ENLARGE

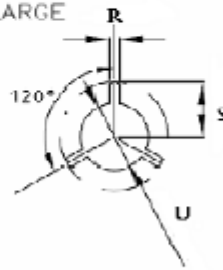

M	N	P	Q	R	S	U
180	60	15.4	13.0	2.0	10.5	13.0