

Customer Code : _____

DATASHEET

DAPU P/N: **O22S-K129-10.00MHz**

Customer P/N: _____

DAPU			Customer Approval
Drew	Audited	Approved	Stamp, please! Thanks!
Date: 2020.04.08			

Guangdong Dapu Telecom Technology Co.,Ltd

Bldg13-16,.N.Ind.Zone,SSL Industry Park, Dongguan City, Guangdong Province, China

TEL: 0086-0769-88010888 FAX: 0086-0769-81800098



1. Electrical Parameters

MODEL: O22S-K129-10.00MHz						
Item	Description	Parameters			Unit	Test Condition
		Min.	Typ.	Max.		
Output	Frequency	10.00			MHz	
	Output Waveform	LVTTTL				
	Output Low Voltage			0.4	V	V _{cc} =5.0V, Load =15pF
	Output High Voltage	2.4			V	V _{cc} =5.0V, Load =15pF
	Duty Cycle	45		55	%	Measurement at -40~85°C
	Spurious Suppression			-90	dBc	
	Rise/Fall Time			4	ns	10%~90% VCC
	Load	13.5	15	16.5	pF	
	Start up time			1	s	90% V _{CC} to the correct frequency output time
Frequency Stabilities	Frequency Accuracy	-1.0		+1.0	$\times 10^{-6}$	Within 90 days after shipment and 15 minutes warm up time(before reflow), Measurement referenced to nominal frequency
		-0.1		+0.1	$\times 10^{-6}$	Within 90 days after shipment and 5 minutes warm up time(after reflow), Measurement referenced to initial frequency (after 2 hours and 5 minutes warm up time after reflow)
		-1.0		+1.0	$\times 10^{-6}$	After 2 hours and 5 minutes warm up time (after reflow), Measurement referenced to the frequency (before reflow)
	Frequency Stability vs. Operating Temperature Range	-3.0		+3.0	$\times 10^{-9}$	TA varied from 0 to 75°C, V _{cc} =5.0V, and Load = 15pF. Measurement referenced to frequency observed With TA = 25°C, V _{cc} =5.0V .
	Frequency Tolerance after Temperature compensated vs Operating Temperature Range	-0.3		+0.3	$\times 10^{-9}$	TA varied from 0 to 75°C, V _{cc} =5.0V, and Load = 15 pF. Measurement referenced to frequency observed With TA = 25°C, V _{cc} =5.0V.
		-5		+5	$\times 10^{-6}$	TA varied from -40 to 85°C, V _{cc} =5.0V, and Load = 15 pF. Measurement referenced to frequency observed With TA = 25°C, V _{cc} =5.0V. air condition.



Frequency Stabilities	Short-Term Stability: Allan Variance			0.01	$\times 10^{-9}$	Temperature stability, no EMI\EMC or other interference, test after power for 1hour ref. to 25°C; 1s.
				0.015	$\times 10$	Temperature stability, no EMI\EMC or other interference, test after power for 1hour ref. to 25°C; 10s.
				0.05	$\times 10$	Temperature stability, no EMI\EMC or other interference, test after power for 1hour ref. to 25°C; 100s.
	Frequency Stability vs. Supply Voltage	-1		1	$\times 10^{-9}$	TA =25°C, Vcc varied from 4.75 to 5.25V and Load =15pF. Measurement referenced to frequency observed with TA = 25°C, V _{cc} =5.0V.
	Frequency Tolerance vs Load	-1		1	$\times 10^{-9}$	10% Load Change Measurement referenced to frequency observed with TA = 25°C, V _{cc} =5.0V.
	Temperature Resolution			1	°C	TA varied from 0 to75 °C, V _{cc} =5.0V, and Load = 15pF.Measurement TA
	Aging Tolerance per day	-0.5		+0.5	$\times 10^{-9}$	Vcc, TA constant Measurement referenced to frequency observed with TA=25 °C ,V _{cc} =5.0V. and after 30 days of operation
	Aging Tolerance per month	-12		+12	$\times 10^{-9}$	
	Aging Tolerance 1 Years	-0.08		+0.08	$\times 10^{-6}$	
	Aging Tolerance 10 Years	-0.5		+0.5	$\times 10^{-6}$	
Power Supply	Supply Voltage	4.75	5.0	5.25	V	
	Steady Consumption			300	mA	@25°C
	Warm up current			700	mA	When all temp range
	Warm Up Time			5	minute	
	Warm Up	-0.02		+0.02	$\times 10^{-6}$	After warm up 10 minute. Measurement referenced to frequency observed with TA = 25 °C ,V _{cc} =5.0V. and after 24 hour of operation.
Phase Noise	Phase Noise			-80	dBc/Hz	1Hz
				-120		10Hz
				-140		100Hz
				-145		1KHz
				-150		10KHz
				-150		100KHz



Environmental Conditions	Operable Temperature range	-40		85	°C		
	Operating Temperature	0		75	°C		
	Storage Temperature	-55		105	°C		
	Temperature Rate of Change			1	°C/min		
	Jitter			1.6	ps-rms	12kHz-5MHz	
	Air-tightness			0.1	Pa.cm3/s	Not include PCB conversion board.	
	ESD Level	Human Body Model, class2: 2000V to 4000V; ANSI/ESDA/JEDEC JS-001-2010.					
		Machine Model, class B: 200V to 400V; JEDEC JESD22-A115C.					
	Moisture Sensitivity Level	Level 2.					
	Vibration	Test Condition: 0.75mm ;acceleration:10g;10Hz~500Hz, one cycle per 30 min, test 2 hour. (3 times for each 3 directions X , Y , Z), IEC 68-2-06 Test Fc.					
Shock	50g; 11ms; half sine wave (3 times for each 3 directions X , Y, Z),IEC 68-2-27 Test Ea/Severity 50A.						
Full Package Storage	Relative Humidity (%)	20% ~70%					
	Temperature (°C)	-10~35°C					



2. Mechanical Structure (mm)

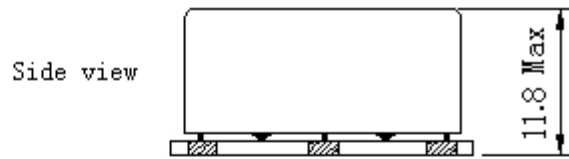
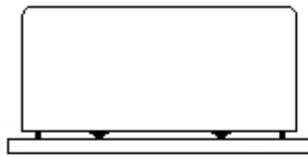
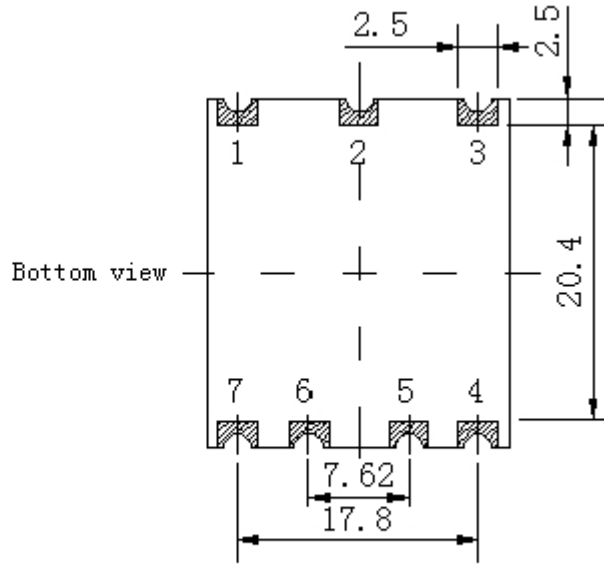
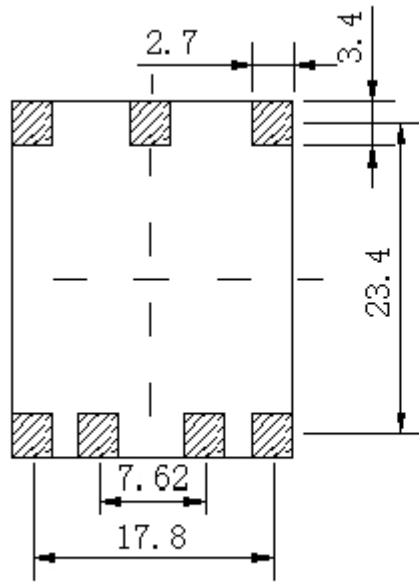

PIN FUNCTION

PIN	FUNCTION
1	NC
2	NC
3	Supply Voltage
4	RF Output
5	SCL
6	SDA
7	GND

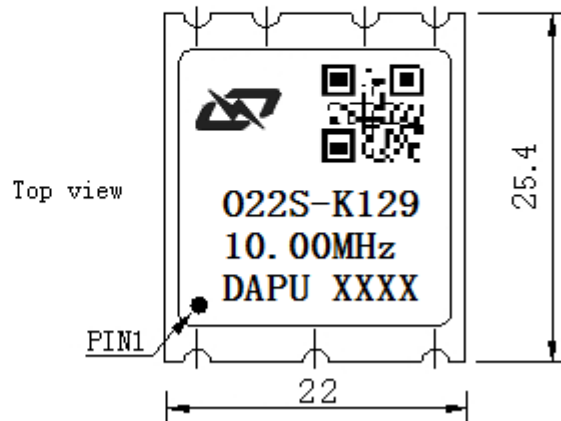

Note1: Tolerance $\pm 0.20\text{mm}$ without mark

Note2: The first two xx representative: week
After two xx representative: year

Note3: Referential weight 10g

Note4: NC is not connect



3. I²C Devices Address

3.1. 2kbit I²C SERIAL EEPROM

Device name : AT24C02

Device supplier : Atmel

Device address : 1010 100

Memory map

Address	Size bytes	Parameter	Format	Value
0000h~0000h	1	EEPROM map version	unsigned byte	01h
0001h~0001h	1	User Reserved		00h
0002h~0004h	3	Vendor ID(3 characters)	ASCII	DP
0005h~0024h	32	Vendor Product ID	ASCII	O22S-K129-10.00MHz
0025h~0028h	4	Nominal frequency in Hertz	32-bit unsigned integer	10000000
0029h~002Ch	4	Device serial number	32-bit unsigned integer	001
002Dh~0032h	6	Date code of manufacture	ASCII	“YYMMDD”
0033h~003Fh	13	User Reserved		00h
0040h~0047h	8	A ₀	64-bit floating point	0.1334
0048h~004Fh	8	A ₁	64-bit floating point	-0.005225
0050h~0057h	8	A ₂	64-bit floating point	3.77E-05
0058h~005Fh	8	A ₃	64-bit floating point	-9.07E-07
0060h~0067h	8	A ₄	64-bit floating point	1.99E-08
0068h~006Fh	8	A ₅	64-bit floating point	-1.85E-10
0070h~0077h	8	B ₀	64-bit floating point	-101.583
0078h~007Fh	8	B ₁	64-bit floating point	0.740016
0080h~009Fh	32	User Reserved		00h
00A0h~00FFh	96	Vendor Reserved		

Note: All numerical values are stored in little endian format

3.2. Analog-to-Digital Converter

Device name : ADC081C027

Device supplier : TI

Device address : 1010 000

Initialize the register address: 0000 0010

The initialization value: 0010 0000

Note: More detailed information see the datasheet provide by the TI.



4. Temperature measurement and compensation scheme

Temperature compensation formula:

$$A_5P^5 + A_4P^4 + A_3P^3 + A_2P^2 + A_1P + A_0 = \frac{f(P) - f(P_{ref})}{f(P_{ref})}$$

A_x: Temperature compensation parameters (see register list)

P: This parameter is read by ADC and is related to temperature.

f(P): measured frequency.

P_{ref}: Parameter variables associated with the reference Temperature (25°C)

OCXO Ambient temperature calculation formula:

$$B_1P + B_0 = Ta[°C]$$

5. Test Circuit

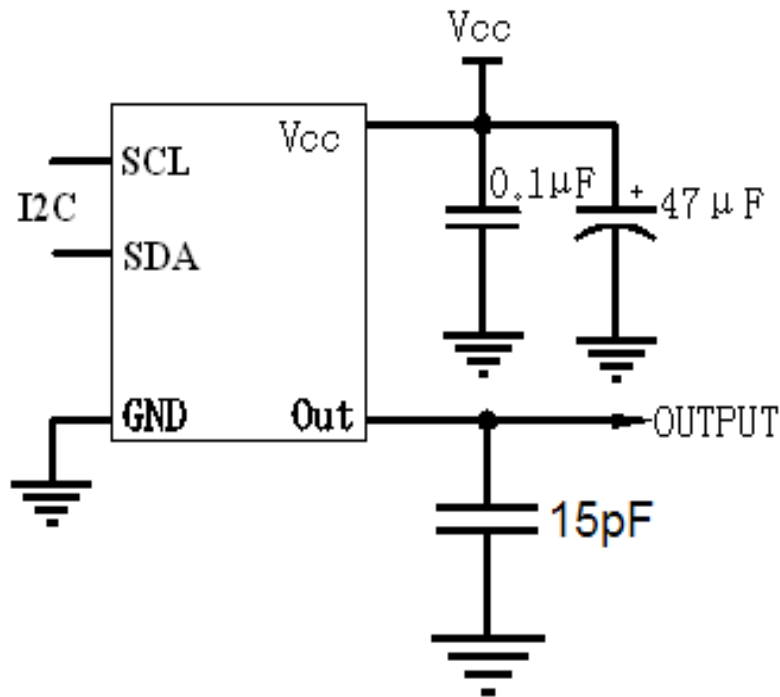



6. Reflow Soldering Curve (RoHS)

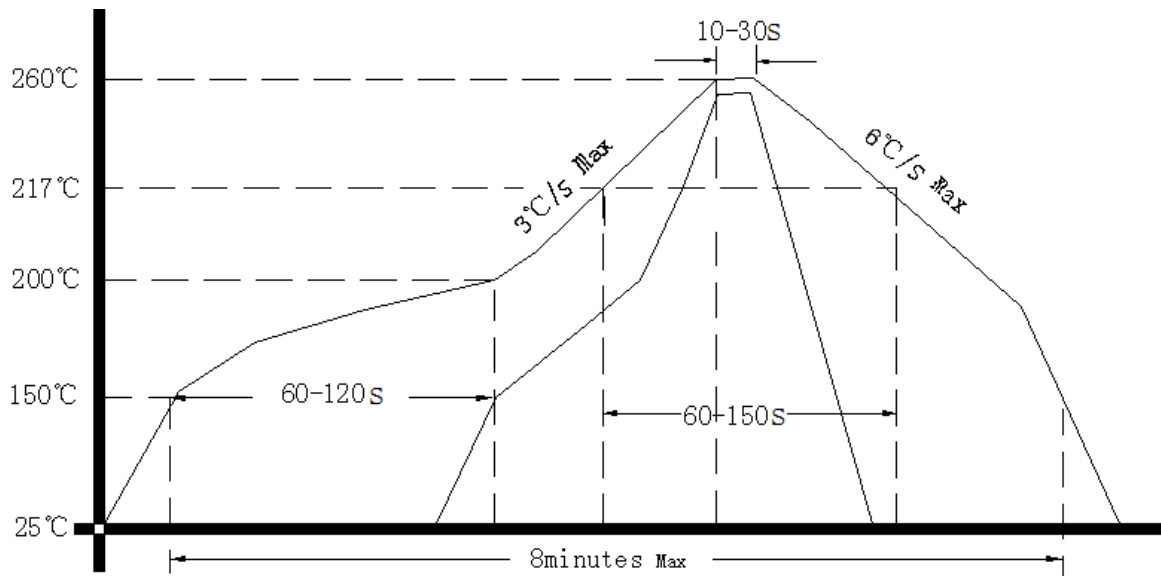

7. Package: Tape & Reel (mm)

