

Customer Code : _____

DATASHEET

DAPU P/N: DPBA5000002

Plot			The Label
Drew	Audited	Approved	Stamp, please! Thanks!
Date: 2020.04.09			

Guangdong Dapu Telecom Technology Co.,Ltd

Bldg16,.N.Ind.Zone,SSL Industry Park, Dongguan City, Guangdong Province, China

TEL: 0086-0769-88010888 FAX: 0086-0769-81800098



1、Electrical Parameters

MODEL: DPBA5000002							
No.	Parameters	SYM.	Electrical Spec.				Notes
			Min.	Typ.	Max.	Units	
1	Nominal Frequency	FL	50.00			MHz	
2	Output Waveform		LVPECL				
3							
4	Supply Voltage		3.135	3.3	3.465	V	
5	Frequency Stability	F-stab	-50		+50	$\times 10^{-6}$	Includes all combinations of operating temperature, load changes, rated input(supply) voltage changes, initial calibration tolerance(25°C), aging(5years at 40°C average effective ambient temperature), shock and vibration.
6	Operating Temperature	T-opr	-40	~	+85	°C	
7	Storage Temperature	T-stg	-55	~	+125	°C	
8	Supply Current, Output Enabled	Icc_OE	-		60	mA	
9	Supply Current, Output Disabled	Icc_OD			60	mA	
10	Rise/Full Time	Tr、Tf			600	ps	20%~80%
11	Duty Cycle	DC	45		55	%	Measured 50% of waveform.
12	Input Voltage(pin1), Output Enable		0.7Vcc			V	Or open
13	Input Voltage(pin1), Output Disable				0.3Vcc	V	Output is Hi-Z, Low power standby.
14	Output Voltage "0"Level	V _{OL}			Vcc-1.55	V	
15	Output Voltage "1"Level	V _{OH}	Vcc-1.2			V	
16	Output Load		50			Ω	Vcc-2V
17	Start up Time	T_start	-		3	ms	
18	Output Enable/Disable Delay.	T_oe	-	-	80	ns	
19	Jitter,(Peak to Peak)	Pk-Pk	-		30	ps	100000 random periods.
20	Phase Jitter	RMS(1-σ)			1	ps	12kHz ~ 20MHz frequency band



21	Mechanical Shock	MIL-STD-883,Method 1011,condition A.
	Mechanical Vibration	MIL-STD-883,Method 2007,condition A
	RESISTANCE TO SOLDERING HEAT	J-STD-020D Table 5-2 Pb-free devices
	MOISTURE RESISTANCE	MIL-STD-883,Method1004.
	HAZARDOUS SUBSTANCE	Pb - free and RoHS/ Green Compliant

2、Mechanical Structure(mm)

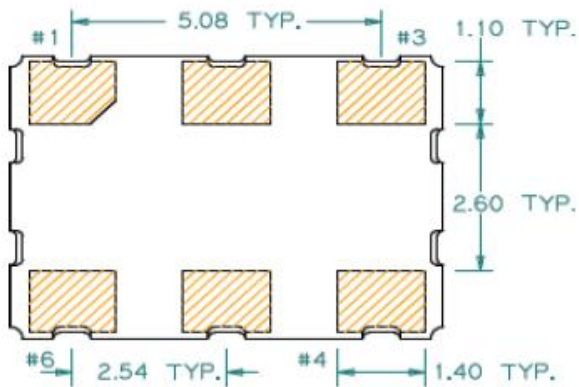
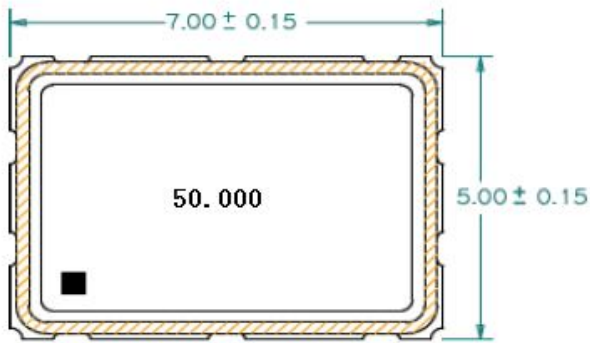

Recommended Land Pattern*

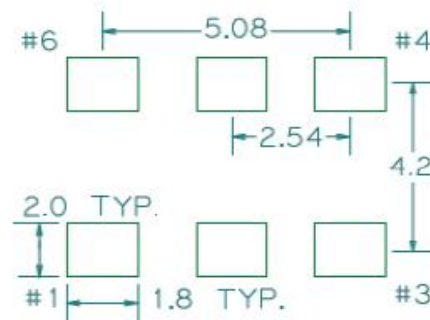

*External high-frequency power decoupling is recommended.(see test circuit for minimum recommendation). To ensure optimal performance, do not route traces beneath the package.

Pin	Function
1	OE
2	NC
3	Ground
4	Q
5	\overline{Q}
6	V _{CC}



3、 TEST CIRCUIT

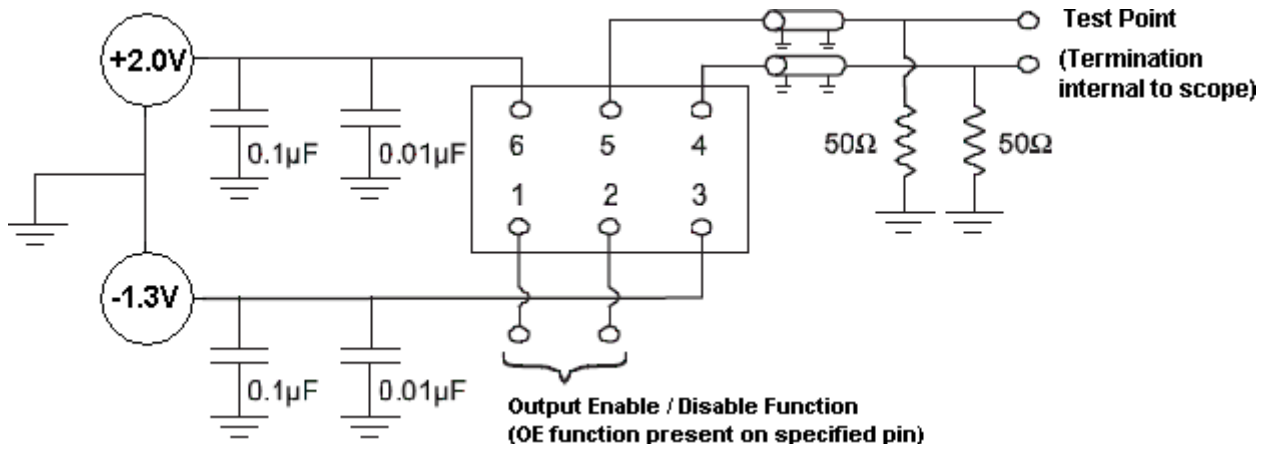

4、 OUTPUT WAVEFORM

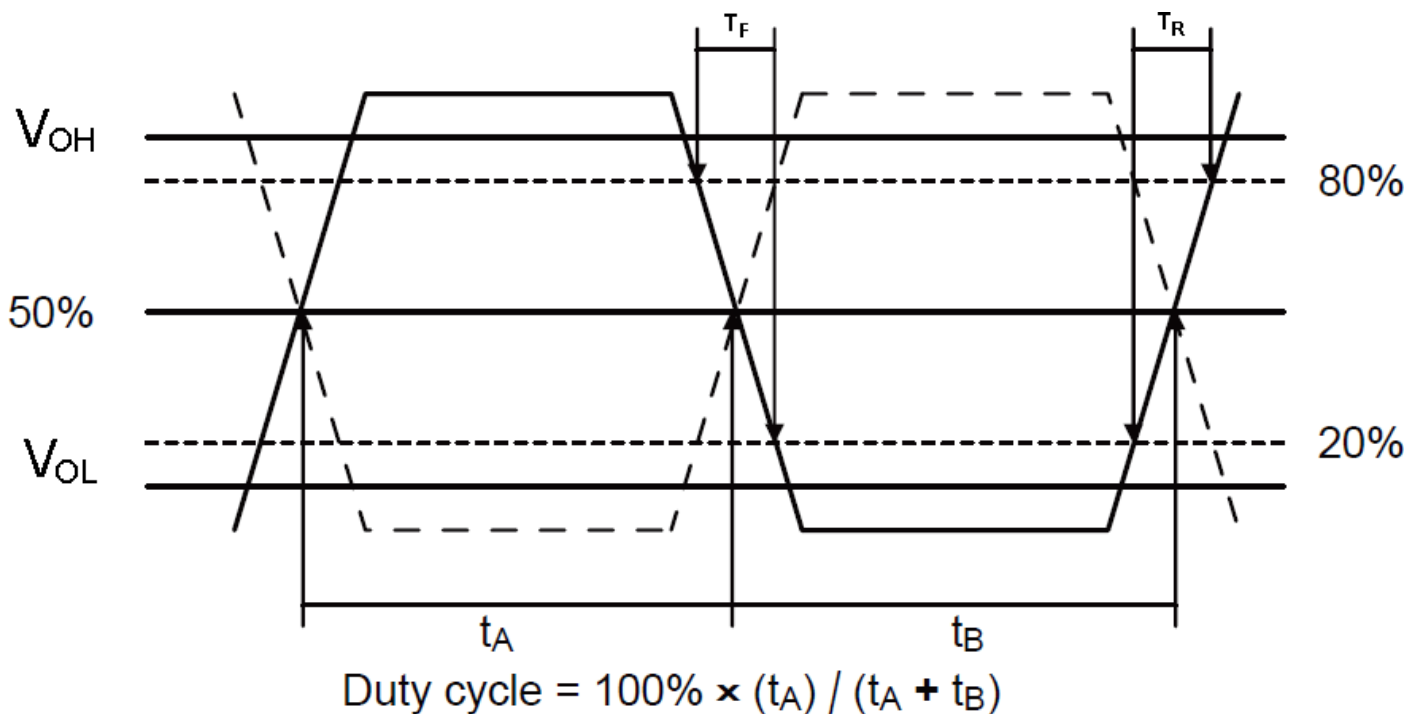



5、 Reflow Soldering Curve (RoHS)

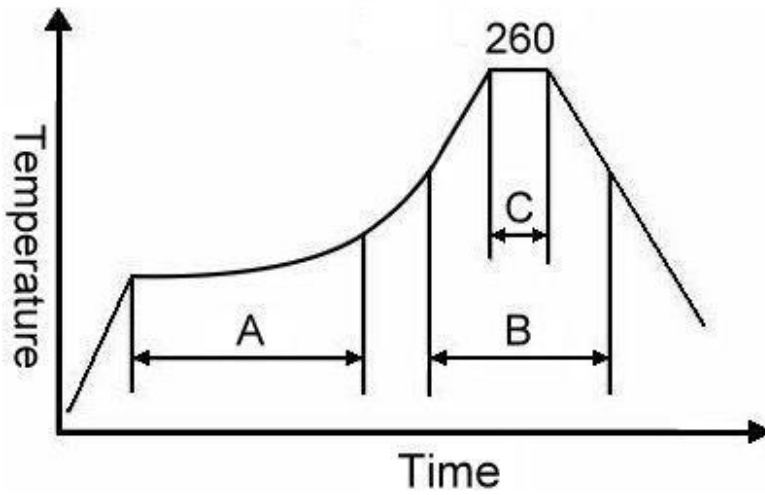

Note:

	Stage	Temperature	Time
A	Preheat	150~200°C	60~120 Sec
B	Primary Heat	217°C	60~150 Sec
C	Peak	260°C	10 Sec

6、 Package: Tape & Reel (mm)

