

Customer Code: _____

DATASHEET

DAPU P/N: OSC324-D106-KD-35.328MHz

DAPU			Customer Approval
Drew	Audited	Approved	Stamp, please! Thanks!
Date: 2020.03.13			

Guangdong Dapu Telecom Technology Co.,Ltd

Bldg16,.N.Ind.Zone,SSL Industry Park, Dongguan City, Guangdong Province, China

TEL: 0086-0769-88010888 FAX: 0086-0769-81800098



1、 Electrical Parameters

MODEL: OSC324-D106-KD-35.328MHz							
No.	Parameters	SYM.	Electrical Spec.				Notes
			Min.	Typ.	Max.	Units	
1	Nominal Frequency	FL	35.328			MHz	
2	Frequency Stability	-	-20	~	+20	$\times 10^{-6}$	
3	Operating Temperature	Topr	-40	~	85	$^{\circ}\text{C}$	
4	Storage Temperature	Tstg	-55	~	125	$^{\circ}\text{C}$	
5	Supply Voltage	VDD		3.3		V	
6	Input Current	Icc	-	3.8	4.5	mA	
7	Output waveform		HCMOS				
8	Output Load:	CL	15			pF	
9	Output Voltage High	VOH	90%	-	-	Vdd	
10	Output Voltage Low	VOL	-	-	10%	Vdd	
11	Rise/Fall Time	Tr、 Tf	-	1.0	2.0	ns	20%-80% VDD Level
12	Aging	-	-1.0	~	1.0	$\times 10^{-6}$	1st. Year at 25 $^{\circ}\text{C}$
13	Input Voltage High	VIH	70%	-	-	Vdd	Pin 1,OE
14	Input Voltage Low	VIL	-	-	30%	Vdd	Pin 1,OE
15	OE Disable Current	I_OD	-	-	4	mA	
16	Standby Current	I_std	-	2.6	4.3	μA	
17	Duty Cycle	-	45	~	55	%	
18	Phase Jitter	T_phj	-	0.5	0.9	ps	900 kHz~7.5 MHz
19	Start-Up Time	T_start	-	-	5	ms	Measured from the time Vdd reaches its rated minimum value
20	Enable/Disable Time	T_oe	-	-	130	ns	
21	Input Pull-up Impedence	Z_in	-	87	100	K Ω	Pin 1, OE logic high or logic low, or ST logic high
22	Drop Test	75 cm height,3 times on concrete floor .					JIS C6701



23	ESD Level	Human Body Model, class2: 2000V to 4000V; ANSI/ESDA/JEDEC JS-001-2010.	
		Machine Model, class B: 200V to 400V; ANSI/ESDA/JEDEC JS-001-2010.	
24	Moisture Sensitivity Level	Level 2.	
25	Mechanical Shock	Device are shocked to half sine wave (1000 G) three mutually. perpendicular axes each 3 times. 0.5m sec. duration time	MIL-STD-202F
26	Vibration	Frequency range 10 ~ 2000 Hz Amplitude 1.52 mm/20G Sweep time 20 minutes perpendicular axes each test time 4 hours (Total test time 12 hours)	MIL-STD-883E

2、 Mechanical Structure(mm)

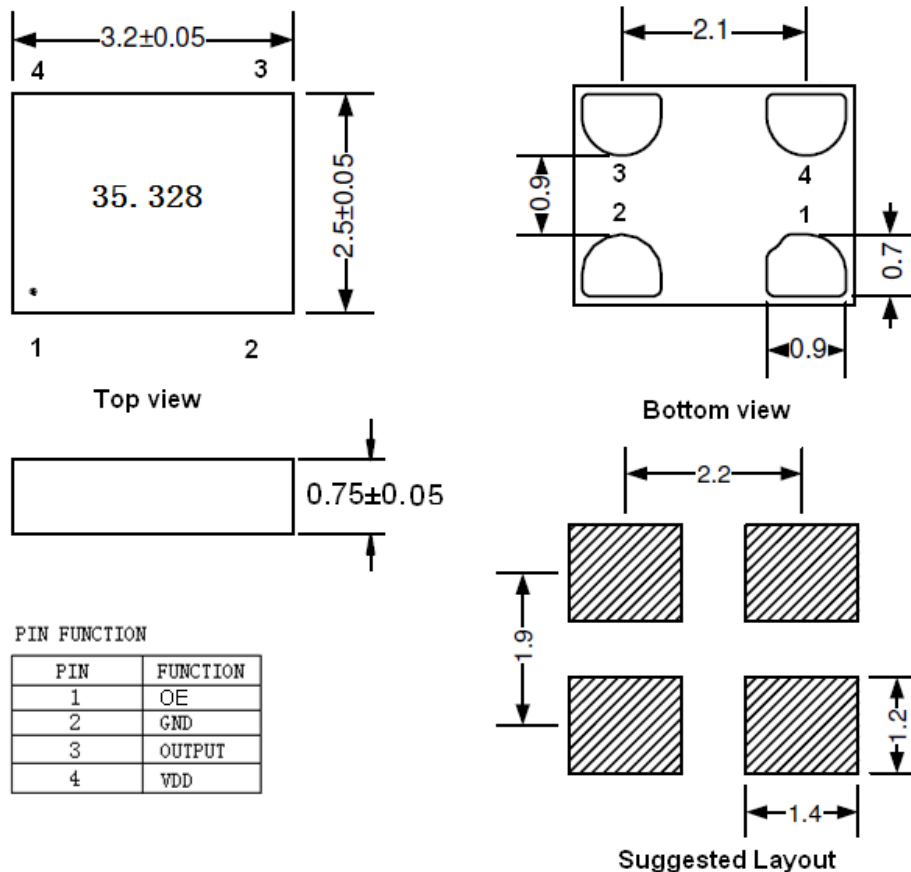

Note1:Tolerance ±0.2mm without mark

Note2: The first two xx representative: week After two xx representative: year

Note3: Referential Weight 0.2g



3、 Test Circuit

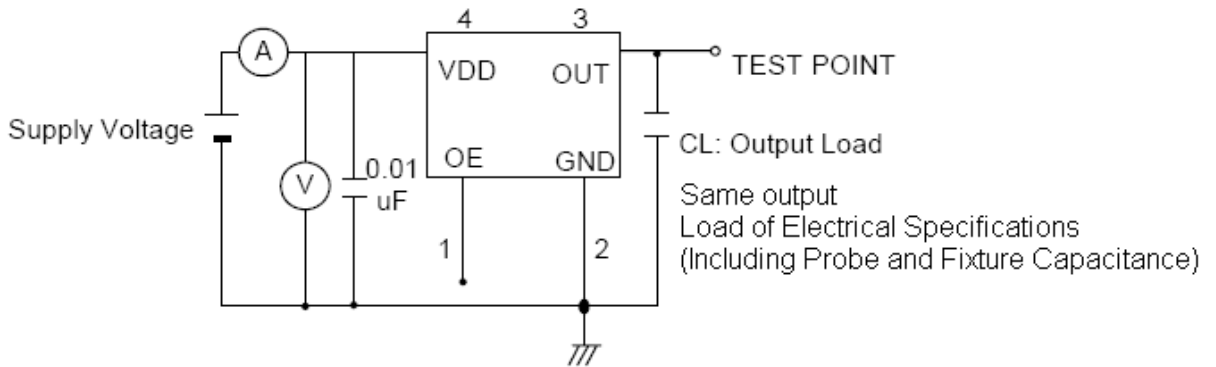

- Control input (output enable/disable)
- Logic 1 or open on pad 1: Oscillator output
- Logic 0 on pad 1 : Disable output to high impedance

4、 Reflow Soldering Curve (RoHS)

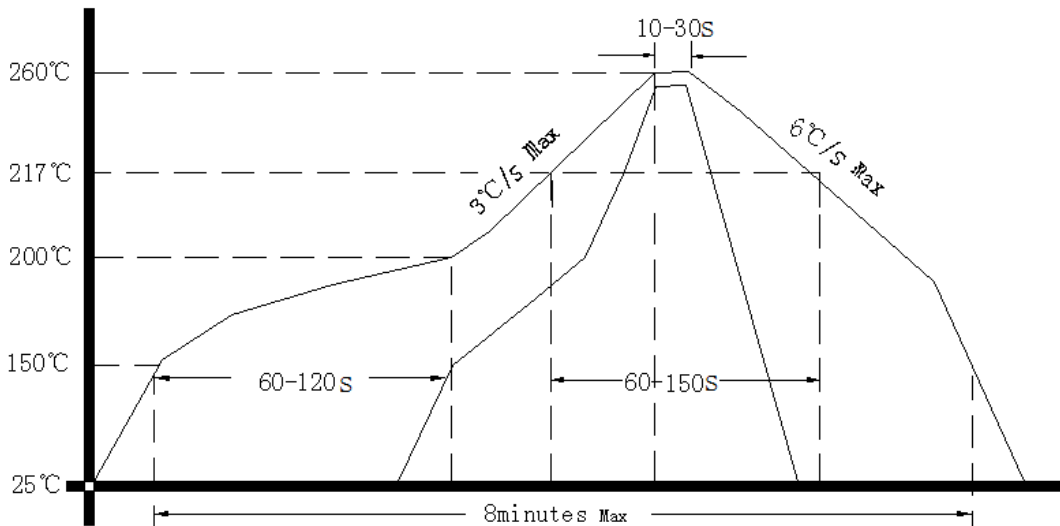

5、 Package: Tape & Reel (mm)

