

Customer Code : \_\_\_\_\_

# DATASHEET

DAPU P/N:     **T75A-0802-19.44MHz**    

Customer P/N: \_\_\_\_\_

DAPU			Customer Approval
Drew	Audited	Approved	Stamp, please! Thanks!
Date: 2020.03.30			

## Guangdong Dapu Telecom Technology Co.,Ltd

Bldg 16,.N.Ind.Zone,SSL Industry Park, Dongguan City, Guangdong Province, China

TEL: 0086-0769-88010888 FAX: 0086-0769-81800098





## 1. Electrical Parameters

MODEL: T75A-0802-19.44MHz						
Item	Description	Parameters			Unit	Test Condition
		Min.	Typ.	Max.		
Output	Frequency	19.44			MHz	
	Output Waveform	HCMOS				
	Output Low Voltage			0.33	V	$V_{cc}=3.3V, O_{load}=15\text{ pF}$
	Output High Voltage	2.97			V	$V_{cc}=3.3V, O_{load}=15\text{ pF}$
	Duty Cycle	45	50	55	%	@50%
	Rise / Fall Time (10%~90%)			9	ns	@25°C
	Load	14.25	15	15.75	pF	
Frequency Stabilities	Frequency Tolerance vs. Operating Temperature Range	-0.28		+0.28	$\times 10^{-6}$	$T_A$ varied from -20°C to 70°C, measurement referenced to frequency observed with $f_{ref}=(f_{max}+f_{min})/2, V_{cc}=3.3V, O_{load}=15\text{ pF}$ , temperature variable speed less than 2°C per minute.
	Holdover Stability	-0.32		+0.32	$\times 10^{-6}$	Include: Frequency Tolerance vs. Operating Temperature Range, Supply Voltage $3.3V \pm 5\%$ and Ageing 24hours.
	Free-Run Accuracy.incl.	-4.6		+4.6	$\times 10^{-6}$	Include: Calibration@25°C, Temperature from -20°C to 70°C, Supply Voltage $3.3V \pm 5\%$ , Load $15\text{ pF} \pm 5\%$ , Reflow soldering and Ageing 20years, Ref. to $F_O$ .
Power Supply	Current Consumption			6	mA	@25°C, $V_{cc}=3.3V, O_{Load}=15\text{ pF}$ .
	Supply Voltage	3.135	3.3	3.465	V	
Phase Noise	Phase Noise @25°C			-85	dBc/Hz	10Hz
				-105		100Hz
				-120		1KHz
				-130		10KHz
Environmental Conditions	Operable Temperature	-20		+70	°C	
	Storage Temperature	-40		+90	°C	
	ESD Level	Human Body Model, class2: 2000V to 4000V; ANSI/ESDA/JEDEC JS-001-2010.				
		Machine Model, class B: 200V to 400V; JEDEC JESD22-A115C.				
	Moisture Sensitivity Level	Level 3.				
	Vibration	Test Condition: 0.75mm ;acceleration:10g;10Hz~2000Hz, one cycle per 30 min, test 2 hour. (3 times for each 3 directions X , Y , Z ).IEC 68-2-06 Test Fc.				
Shock	100g; 6ms; half sine wave (3 times for each 3 directions X , Y , Z ),IEC 68-2-27 Test Ea/Severity 50A.					



Full Package Storage	Relative Humidity (%)	20%~70%
	Temperature (°C)	-10~35°C

## 2. Mechanical Structure(mm)

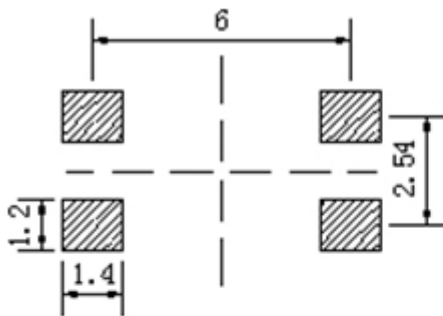

Solder pad layout

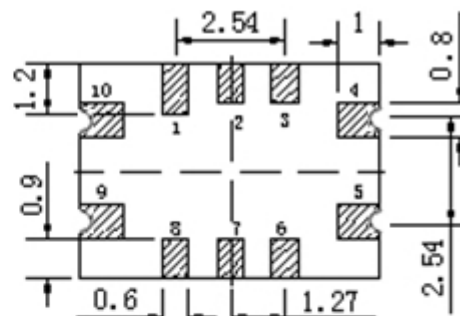

Bottom view

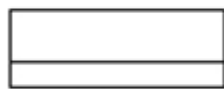

Right view

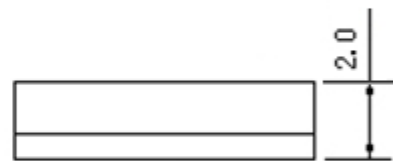

Front view

### PIN FUNCTION

PIN	NOTATION	FUNCTION
1, 2, 3, 6, 7, 8	NC	Not Connect
4	GND	GND
5	OUTPUT	RF Output
9	VCC	Supply Voltage
10	NC	Not Connect

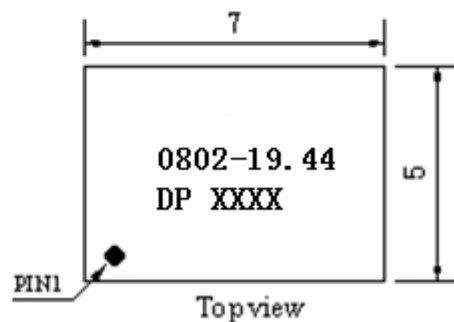

Top view

**Note1:** Tolerance  $\pm 0.2\text{mm}$  without mark

**Note2:** The first two xx representative: week

After two xx representative: year

**Note3:** Referential Weight 0.2g

**Note4:** NC is not connect



### 3. Test circuit

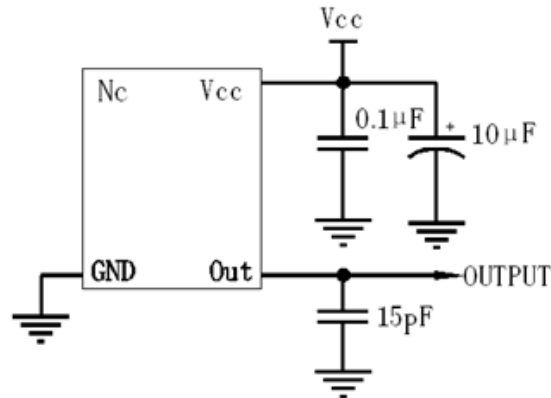

### 4. Reflow Soldering Curve (RoHS)

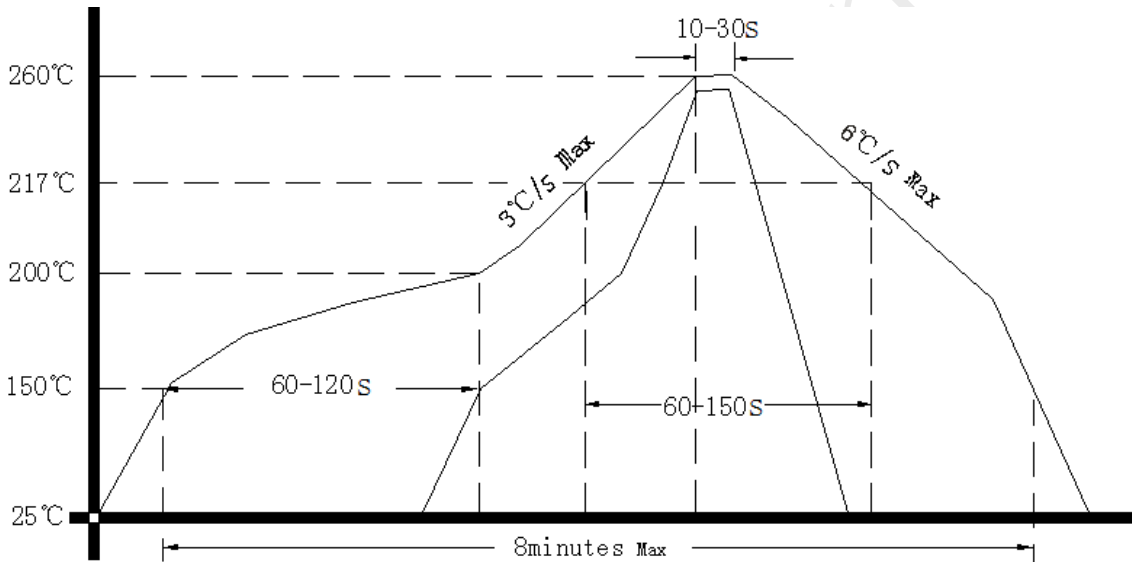

### 5. Package: Tape & Reel (mm)

