

Customer Code: _____

DATASHEET

DAPU P/N: **DP7X3000001**

DAPU			Customer Approval
Drew	Audited	Approved	Stamp, please! Thanks!
Date: 2019.10.11			

Guangdong Dapu Telecom Technology Co.,Ltd

Bldg16,,N.Ind.Zone,SSL Industry Park, Dongguan City, Guangdong Province, China

TEL: 0086-0769-88010888 FAX: 0086-0769-81800098



1、Electrical Parameters

MODEL: DP7X30000001							
No.	Parameters	SYM.	Electrical Spec.				Notes
			Min.	Typ.	Max.	Units	
1	Nominal Frequency	FL	30.00			MHz	
2	Output Waveform		CMOS				
3	Symmetry	-	45	~	55	%	
4	Frequency stability over operating temperature	-			±30	×10 ⁻⁶	
5	Operating Temperature	Topr	-40	~	+85	°C	
6	Storage Temperature	Tstg	-55	~	+125	°C	
7	Supply Voltage	VDD	2.97	3.3	3.63	V	
8	Input Current				17	mA	
9	Output Load:	CL	15			pF	
10	High Output Voltage	VoH	0.9Vdd	-	-	V	
11	Low Output Voltage	Vol	-	-	0.1Vdd	V	
12	Aging	-	±3			ppm/yr.	1st. Year at 25°C
13	Start up time				10	ms	
14	Rise/ Fall Time	Tr/Tf	-	-	5	ns	
15	Output State Control		Enable				
16	ESD Level	Human Body Model,class2: 2000V to 4000V; ANSI/ESDA/JEDEC JS-001-2010.					
		Machine Model, class B: 200V to 400V; ANSI/ESDA/JEDEC JS-001-2010.					
17	Moisture Sensitivity Level	Level 3.					
18	Vibration	Test Condition: 0.75mm ;acceleration:10g;10Hz~2000Hz, one cycle per 30 min, test 2 hour. (3 times for each 3 directions X , Y , Z) .IEC 68-2-06 Test Fc.					
19	Shock	100g; 6ms; half sine wave (3 times for each 3 directions X , Y , Z),IEC 68-2-27 Test Ea/Severity 50A.					
20	Full Package Storage	Relative humidity (%)		20% ~70%			
		Temperature (°C)		-10~35°C			



2、Mechanical Structure(mm)

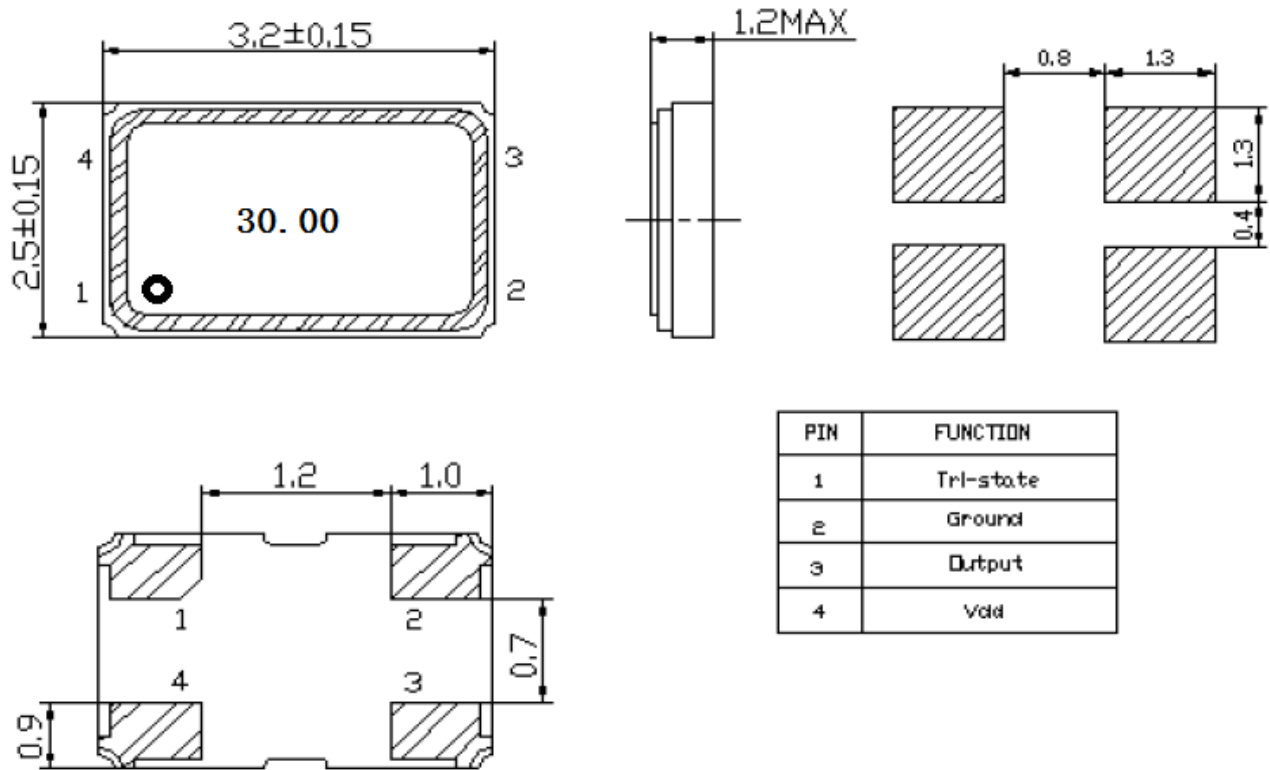

Note1: Tolerance ±0.2mm

3、Reflow Soldering Curve (RoHS)

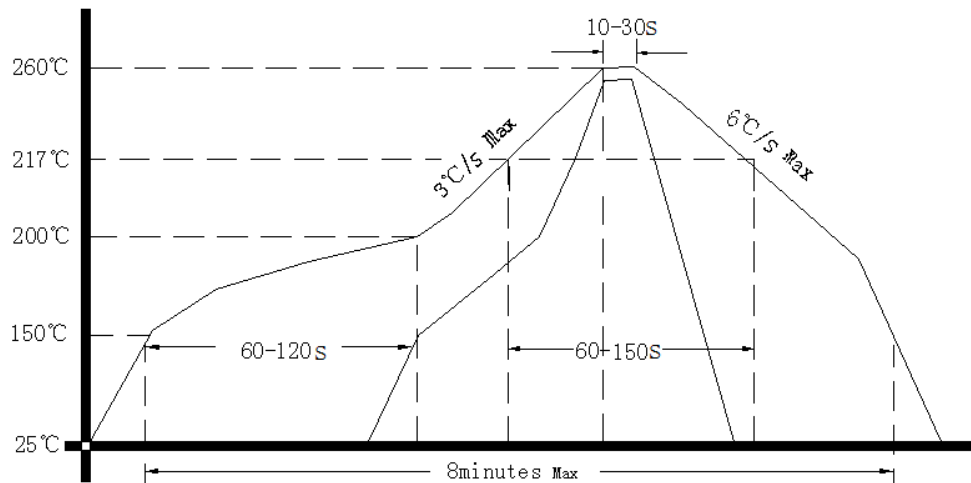



4、 Package: Tape & Reel (mm)

