



Table of amendment

Version	Revision contents	Prepared by	Revised date
1.0	The first issued	<i>Amway</i>	2019.09.10

DAPU Confidential



1. Electrical Parameters

MODEL: O22S-3702-10.00MHz						
Item	Description	Parameters			Unit	Test Condition
		Min.	Typ.	Max.		
Output	Frequency	10.00			MHz	
	Output Waveform	LVCMOS				
	Output Low Voltage			0.4	V	$V_{cc}=3.3V$, Load =15pF
	Output High Voltage	2.4			V	$V_{cc}=3.3V$, Load =15pF
	Duty Cycle	45	50	55	%	
	Spurious Suppression			-90	dBc	
	Rise/Fall Time			8	ns	
	Load	15			pF	
Frequency Stabilities	Initial Frequency Tolerance	-1.0		+1.0	$\times 10^{-6}$	After 2 hours and 5 minutes warm up time (after reflow), Measurement referenced to the frequency (before reflow)
	Frequency Stability vs. Operating Temperature Range	-3.0		+3.0	$\times 10^{-9}$	T_A varied from -40 to 85°C, $V_{cc}=3.3V$, and Load = 15pF. Measurement referenced to frequency observed With $T_A = 25^\circ C$, $V_{cc}=3.3V$.
	Frequency Jump			0.05	$\times 10^{-9}$	
	Hysteresis			0.3	$\times 10^{-9}$	
	Frequency Stability vs. Supply Voltage	-0.5		+0.5	$\times 10^{-9}$	measurement referenced to frequency observed $T_A=25^\circ C$, V_{cc} varied from 3.13V to 3.47V, and $O_{Load}=15pF$.
	Frequency Tolerance vs Load	-0.5		+0.5	$\times 10^{-9}$	5% load change measurement referenced to frequency observed with $T_A=25^\circ C$, $V_{cc}=3.3V$, and $O_{Load}=15pF$.



	Aging Tolerance day	-0.6		+0.6	$\times 10^{-9}$	After 3 days
	Aging Slope Variation (/day)	-0.4		+0.4	$\times 10^{-9}$	
	Aging Tolerance 10 Years	-0.5		+0.5	$\times 10^{-6}$	
Power Supply	Supply Voltage	3.13	3.3	3.47	V	
	Steady Consumption			400	mA	@25°C
	Warm up current			1000	mA	
	Warm-Up Time			5	minutes	@25 °C within $\pm 0.02 \times 10^{-6}$ of final frequency with reference after 1 hours on.
			10	minutes	@25 °C within $\pm 0.01 \times 10^{-6}$ of final frequency with reference after 1 hours on.	
Phase Noise	Phase Noise			-80	dBc/Hz	1Hz
				-120		10Hz
				-140		100Hz
				-145		1KHz
				-150		10KHz
				-150		100KHz
Environmental Conditions	Operating Temperature	-40		+85	°C	
	Storage Temperature	-55		+125	°C	
	ESD Level	Human Body Model, class2: 2000V to 4000V; ANSI/ESDA/JEDEC JS-001-2010.				
		Machine Model, class B: 200V to 400V; ANSI/ESDA/JEDEC JS-001-2010.				
	Moisture Sensitivity Level	Level 3.				
	Vibration	Test Condition: 0.75mm ;acceleration:10g;10Hz~500Hz, one cycle per 30 min, test 2 hour. (3 times for each 3 directions X ,Y , Z), IEC 68-2-06 Test Fc.				
Shock	50g; 11ms; half sine wave (3 times for each 3 directions X ,Y , Z),IEC 68-2-27 Test Ea/Severity 50A.					
Full Package Storage	Relative Humidity (%)	20% ~70%				
	Temperature (°C)	-10~35°C				



2. Mechanical Structure (mm)

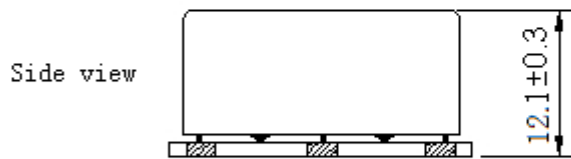
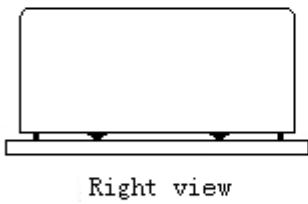
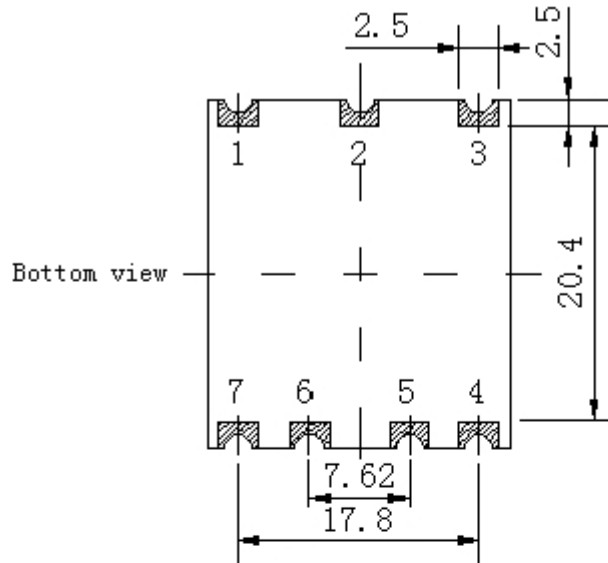
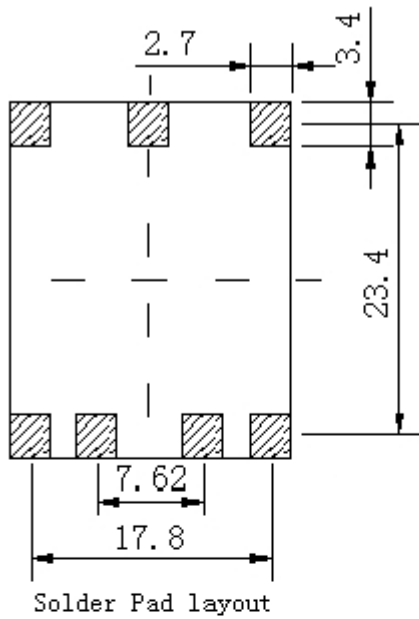

PIN FUNCTION

PIN	FUNCTION
1	NC
2	NC
3	Supply Voltage
4	RF Output
5	SCL
6	SDA
7	GND

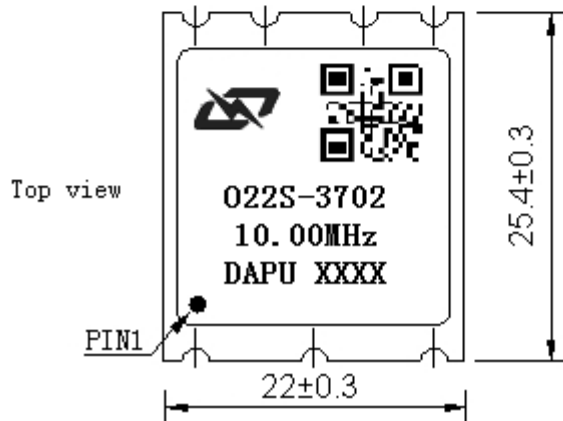

Note1: Tolerance $\pm 0.20\text{mm}$ without mark

Note2: The first two xx representative: week
After two xx representative: year

Note3: Referential weight 10g

Note4: NC is not connect



3. I²C Devices Address

3.1. 2kbit I²C SERIAL EEPROM

Device name : AT24C02

Device supplier : Atmel

Device address : 1010 100

Memory map

Address	Size bytes	Parameter	Format	Value
0000h~0000h	1	EEPROM map version	unsigned byte	01h
0001h~0001h	1	samsung Reserved		00h
0002h~0004h	3	Vendor ID(3 characters)	ASCII	
0005h~0024h	32	Vendor Product ID	ASCII	O22S-3702-10MHz
0025h~0028h	4	Nominal frequency in Hertz	$2^8 * f_1$	9 999 990.95
0029h~002Ch	4	Device serial number	ASCII	
002Dh~0032h	6	Date code of manufacture	ASCII	“YYMMDD”
0033h~003Fh	13	samsung Reserved		00h
0040h~0047h	8	A ₀	$2^{32} * (A_0 * 10^6)$	0.1334
0048h~004Fh	8	A ₁	$2^{32} * (2^{32} + A_1 * 10^6)$	-0.005225
0050h~0057h	8	A ₂	$2^{32} * (A_2 * 10^6)$	3.77E-05
0058h~005Fh	8	A ₃	$2^{32} * (2^{32} + A_3 * 10^6)$	-9.07E-07
0060h~0067h	8	A ₄	$2^{32} * (A_4 * 10^6)$	1.99E-08
0068h~006Fh	8	A ₅	$2^{32} * (2^{32} + A_5 * 10^6)$	-1.85E-10
0070h~0077h	8	B ₀	$2^{32} * (2^{32} + B_0 * 10^6)$	-101.583
0078h~007Fh	8	B ₁	$2^{32} * (B_1 * 10^6)$	0.740016
0080h~009Fh	32	samsung Reserved		00h
00A0h~00FFh	96	Vendor Reserved		

Note: All numerical values are stored in little endian format

3.2. Analog-to-Digital Converter

Device name : ADC081C027

Device supplier : TI

Device address : 1010 000

Initialize the register address: 0000 0010

The initialization value: 0010 0000

Note: More detailed information see the datasheet provide by the TI.



4. Temperature measurement and compensation scheme

Temperature compensation formula:

$$A_5P^5 + A_4P^4 + A_3P^3 + A_2P^2 + A_1P + A_0 = \frac{f(P) - f(P_{ref})}{f(P_{ref})}$$

A_x: Temperature compensation parameters (see register list)

P: This parameter is read by ADC and is related to temperature.

f(P): measured frequency.

P_{ref}: Parameter variables associated with the reference Temperature (25°C)

OCXO Ambient temperature calculation formula:

$$B_1P + B_0 = Ta[°C]$$

5. Test Circuit

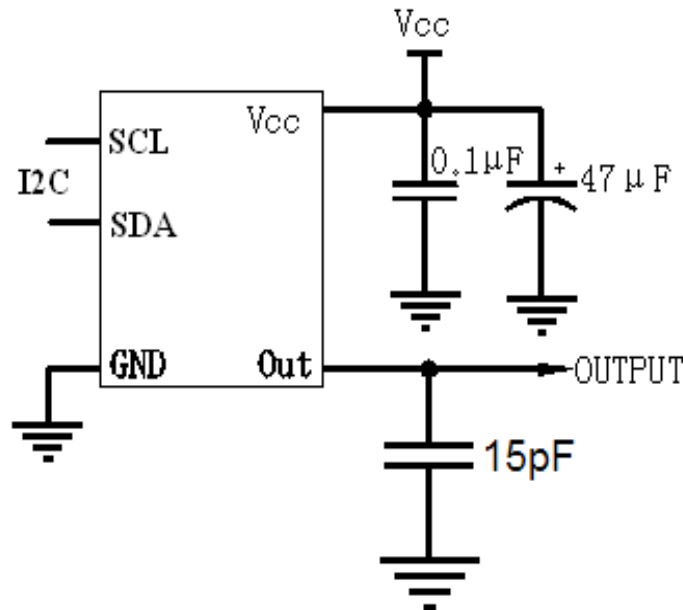



6. Reflow Soldering Curve (RoHS)

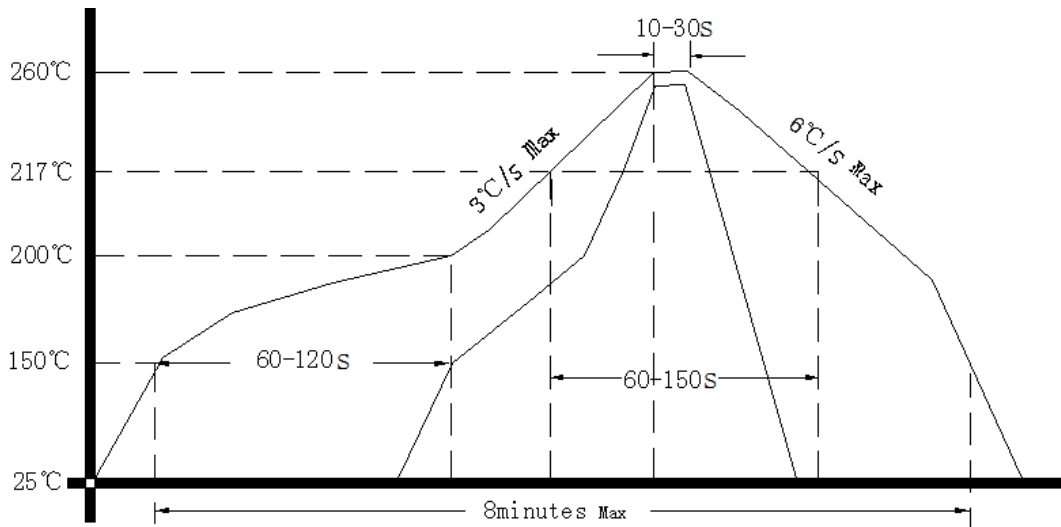

Note: passing through reflow upside down is not supported

7. Package: Tape & Reel (mm)

