

Customer Code : _____

DATASHEET

DAPU P/N: **T11A-A429-31.40MHz**

Customer P/N: _____

DAPU			Customer Approval
Drew	Audited	Approved	Stamp, please! Thanks!
Date: 2019.10.24			

Guangdong Dapu Telecom Technology Co.,Ltd

Bldg13-16,.N.Ind.Zone,SSL Industry Park, Dongguan City, Guangdong Province, China

TEL: 0086-0769-88010888 FAX: 0086-0769-81800098



1. Electrical Parameters

MODEL: T11A-A429-31.40MHz						
Item	Description	Parameters			Unit	Test Condition
		Min.	Typ.	Max.		
Output	Frequency	31.40			MHz	
	Output Waveform	Sine Wave				
	Level	5	6	7	dBm	$O_{load}=50\Omega$
	Harmonics Suppression			-30	dBc	
	Spurious Suppression			-60	dBc	
	Load	50			Ω	
Frequency Stabilities	Frequency Tolerance vs. Operating Temperature Range	-4.0		+4.0	$\times 10^{-6}$	T_A varied from -45°C to 75°C , measurement referenced to frequency observed with $T_A=25^{\circ}\text{C}$, $V_{cc}=5.0\text{V}$, $O_{load}=50\Omega$, temperature variable speed less than 2°C per minute.
	Initial Frequency Tolerance	-3.0		+3.0	$\times 10^{-6}$	Measurement referenced to frequency observed with $T_A=25^{\circ}\text{C}$, $V_{cc}=5.0\text{V}$, within 30 days after ex-works.
	Aging Tolerance 1 Year	-1.0		+1.0	$\times 10^{-6}$	$T_A=25^{\circ}\text{C}$, $V_{cc}=5.0\text{V}$, and after 1h of operation.
Power Supply	Current Consumption			50	mA	@ 25°C , $V_{cc}=5.0\text{V}$, $O_{load}=50\Omega$.
	Supply Voltage	4.75	5.0	5.25	V	
Environmental Conditions	Operable Temperature	-45		+75	$^{\circ}\text{C}$	
	Storage Temperature	-55		+85	$^{\circ}\text{C}$	
	ESD Level	Human Body Model, class2: 2000V to 4000V; ANSI/ESDA/JEDEC JS-001-2010.				
		Machine Model, class B: 200V to 400V; ANSI/ESDA/JEDEC JS-001-2010.				
	Moisture Sensitivity Level	Not humidity sensitive.				
	Vibration	Test Condition: 0.75mm ;acceleration:10g;10Hz~2000Hz, one cycle per 30 min, test 2 hour. (3 times for each 3 directions X , Y , Z).IEC 68-2-06 Test Fc.				
Shock	100g; 6ms; half sine wave (3 times for each 3 directions X , Y , Z),IEC 68-2-27 Test Ea/Severity 50A.					



2. Mechanical Structure(mm)

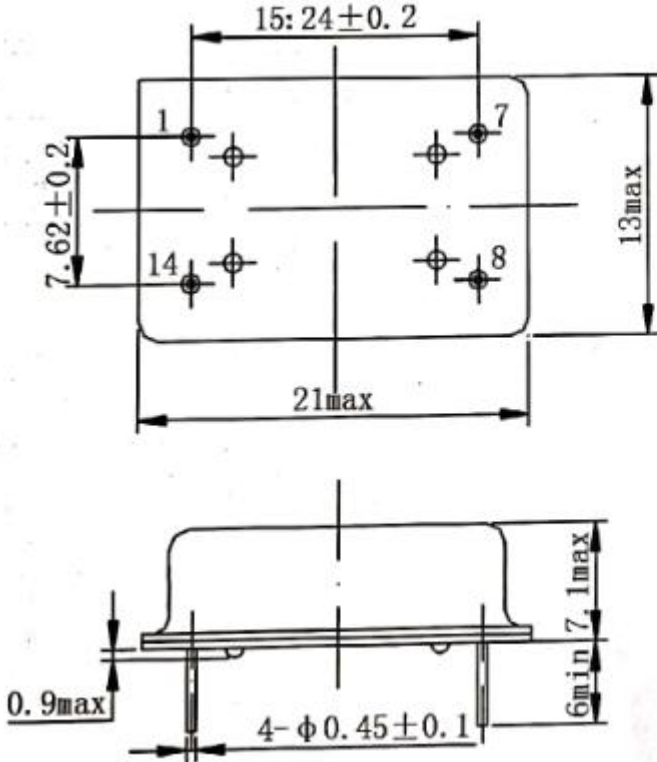

引脚 (PIN)	功能 (FUNCTION)
1	空脚 (NC)
7	接地 (GND)
8	输出 (OUT)
14	电源 (VCC)

标识

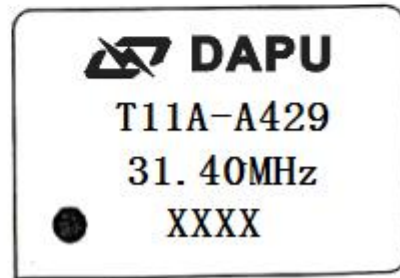

- Note1:** The first two xx representative: week
After two xx representative: year
- Note2:** Referential weight 3.8g
- Note3:** NC is not connect

3. Test circuit

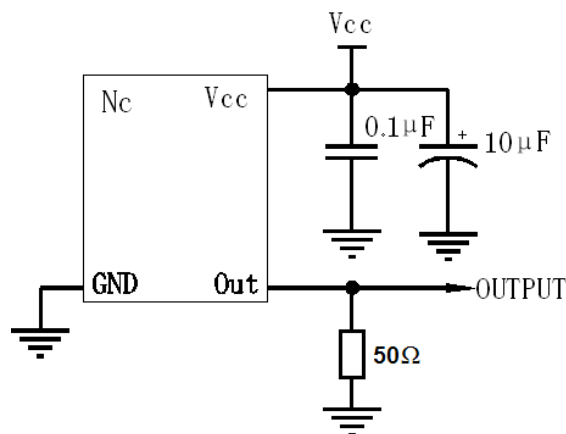



4. Reflow Soldering Curve (RoHS)

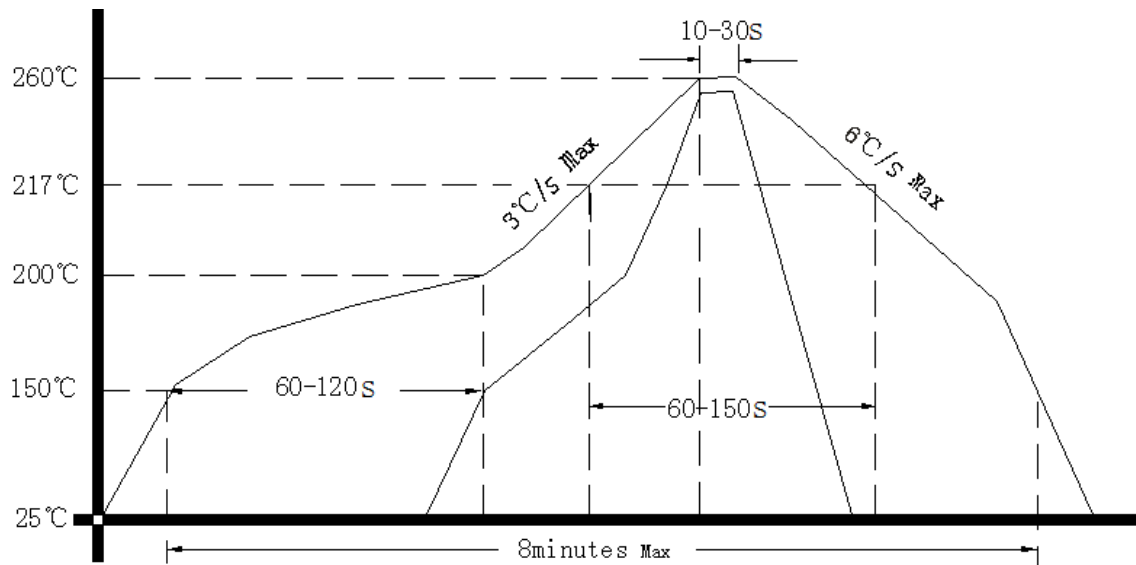

5. Package: PVC Tube,10pcs (mm)

