

Travelling Merchant: _____

DATASHEET

Standard: **DPAB2000002**

Plot			The Label
Drew	Audited	Approved	Stamp, please! Thanks!
Date: 2017.11.15			

Guangdong Dapu Telecom Technology Co.,LTD

Bldg13-16,.N.Ind.Zone,SSL Industry Park, Dongguan City, Guangdong Province, China

TEL: 0086-0769-88010888 FAX: 0086-0769-81800098



1、 Electrical Parameters

MODEL: DPAB2000002							
No.	Parameters	SYM.	Electrical Spec.				Notes
			Min.	Typ.	Max.	Units	
1	Nominal Frequency	FL	20.00			MHz	
2	Oscillation Mode	-	Fundamental				
3	Load Capacitance	CL	20			pF	
4	Frequency Tolerance	-	-20	-	+20	$\times 10^{-6}$	at 25°C $\pm 3^{\circ}\text{C}$
5	Frequency Stability	-	-30	-	+30	$\times 10^{-6}$	with working temperature Reference to 25°C
6	Operating Temperature	-	-40	~	+85	°C	
7	Insulation R	-	500			MΩ	
8	Aging	-	-3	-	+3	$\times 10^{-6}$	@25°C 1st Year
9	Drive Level	DL	-	100		uW	
10	Series Resonant Resistance	CI/RR			30	Ω	
11	Shunt Capacitance C0	C0	5			pF	
12	Storage temperature range		-55		125	°C	
13	ESD Level	Human Body Model,class2: 2000V to 4000V; ANSI/ESDA/JEDEC JS-001-2010					
		Machine Model, class B: 200V to 400V; ANSI/ESDA/JEDEC JS-001-2010					
14	Moisture Sensitivity Level	Level 2					
15	Vibration	Test Condition: 0.75mm ;acceleration:10g;10Hz~2000Hz, one cycle per 30 min, test 2 hour. (3 times for each 3 directions X ,Y , Z). IEC 68-2-06 Test Fc.					
16	Shock	100g; 6ms; half sine wave (3 times for each 3 directions X ,Y , Z),IEC 68-2-27 Test Ea/Severity 50A.					



2、Mechanical Structure(mm)

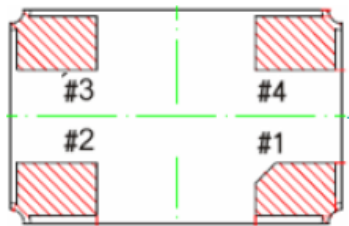
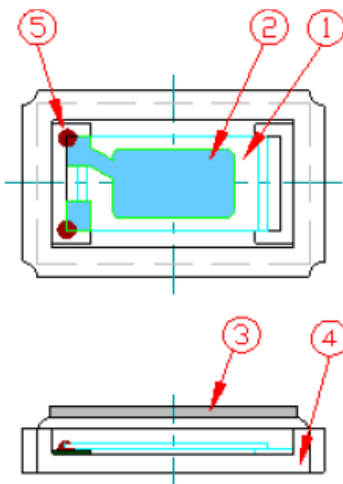
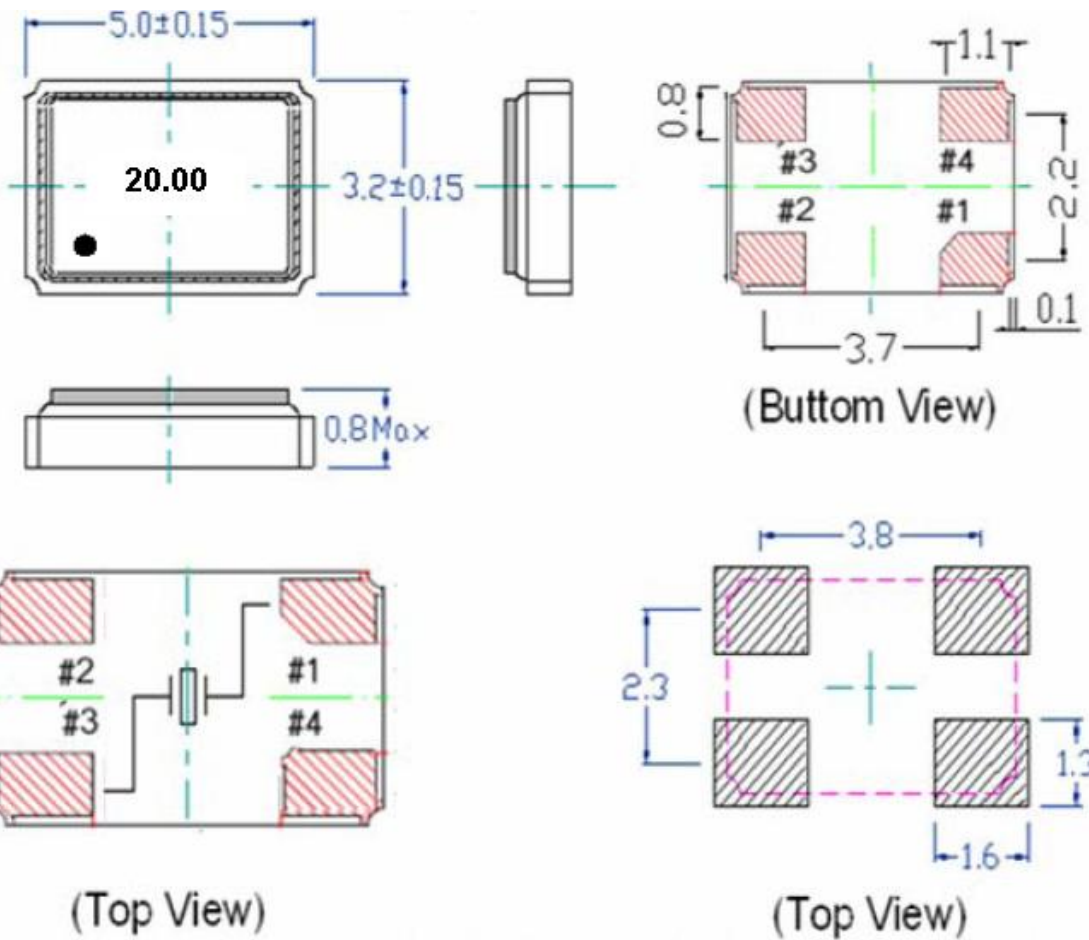

1	Quartz Blank
2	Electrode
3	Lid
4	Base
5	Conductive adhesive



3、 Reflow Soldering Curve (RoHS)

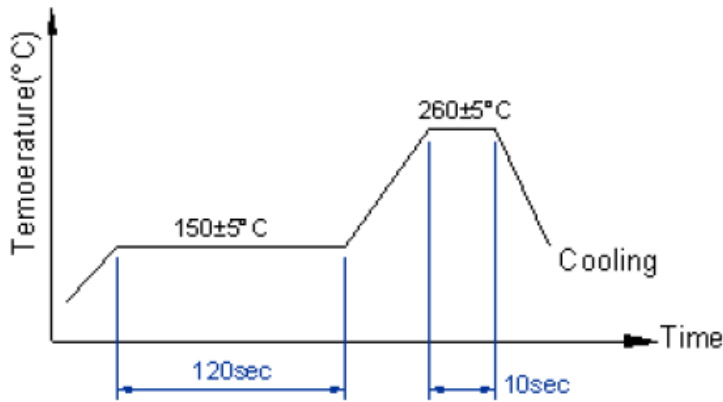

Total Time : 200 Sec.Max
Solder melting point : 185°C

4、 Package: Tape & Reel (mm)

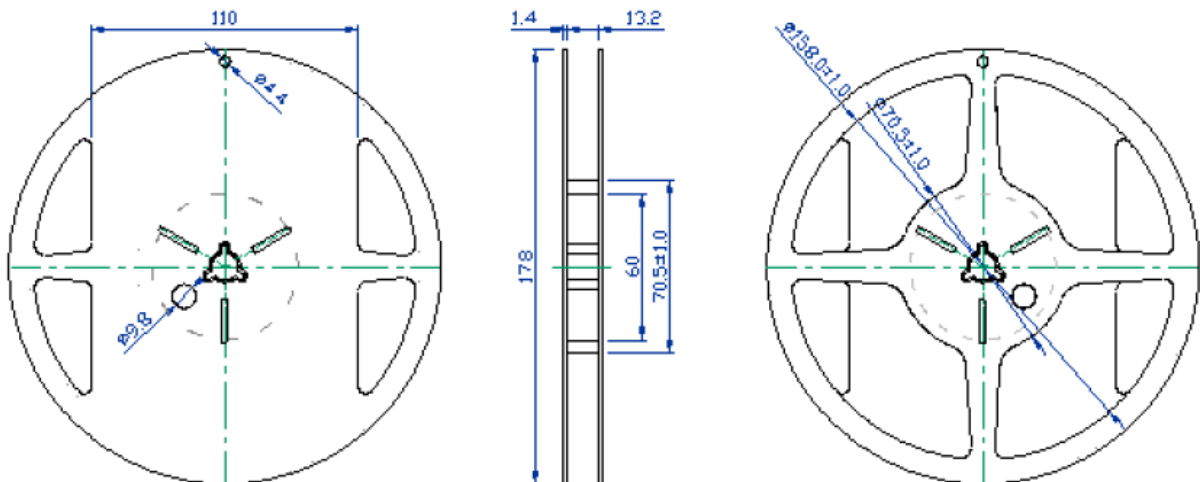
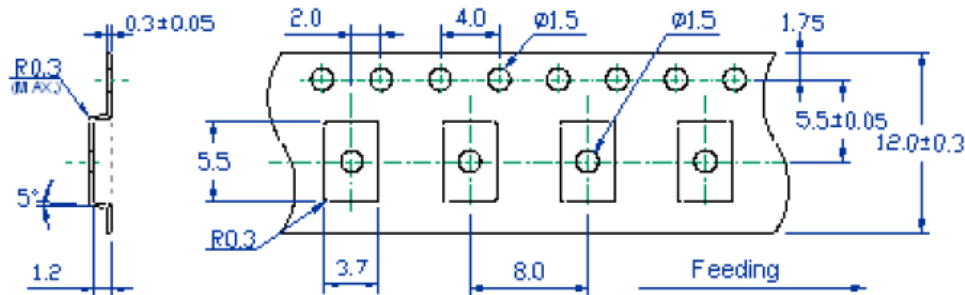

1. 230mm minimum leader which consist of carrier and/or tape followed by a minimum of 160mm of empty carrier tape sealed with cover tape.
2. 160mm minimum trailer of empty carrier tape sealed with cover tape.

