

Travelling Merchant: _____

DATASHEET

Standard: **M936-2602-10.00MHz**

P/N: _____

Plot			The Label
Drew	Audited	Approved	Stamp, please! Thanks!
Date: 2018.04.17			

Guangdong Dapu Telecom Technology Co.,Ltd

Bldg13-16,.N.Ind.Zone,SSL Industry Park, Dongguan City, Guangdong Province, China

TEL: 0086-0769-88010888 FAX: 0086-0769-81800098



1. Electrical Parameters

MODEL: M936-2602-10.00MHz						
Item	Description	Parameters			Unit	Test Condition
		Min.	Typ.	Max.		
Output	Frequency	10.00			MHz	
	Output Waveform	HCMOS				
	Output Low Voltage			0.3	V	$V_{cc}=3.3V, O_{load}=15\text{ pF}$
	Output High Voltage	2.4			V	$V_{cc}=3.3V, O_{load}=15\text{ pF}$
	Duty Cycle	45		55	%	@50%
	Rise / Fall Time (10%~90%)			5	ns	@25°C
	Load	15			pF	
Frequency Stabilities	Frequency Tolerance vs. Operating Temperature Range	-0.03		+0.03	$\times 10^{-6}$	T_A varied from -40°C to 85°C, measurement referenced to frequency observed with $f_{ref}=(f_{max}+f_{min})/2, V_{cc}=3.3V, O_{load}=15\text{ pF}$, temperature variable speed less than 2°C per minute.
	Initial Frequency Tolerance	-0.5		+0.5	$\times 10^{-6}$	Measurement referenced to frequency observed with $T_A=25^\circ\text{C}, V_{cc}=3.3V$ within 30 days after ex-works.
	In a 24h period at constant temperature	-5		+5	$\times 10^{-9}$	after 7 days of continuous operation
	Frequency vs. temperature slope			± 1.0	$\times 10^{-9}/^\circ\text{C}$	-30 °C to +80 °C, temperature variable speed less than 1°C per minute.
				± 1.5	$\times 10^{-9}/^\circ\text{C}$	-40 °C to +85 °C, temperature variable speed less than 1°C per minute.
	Frequency Tolerance vs. Supply Voltage	-0.01		+0.01	$\times 10^{-6}$	measurement referenced to frequency observed $T_A=25^\circ\text{C}, V_{cc}$ varied from 3.13V to 3.47V, and $O_{Load}=15\text{ pF}$.
	Frequency Tolerance vs. Load	-0.01		+0.01	$\times 10^{-6}$	10% load change measurement referenced to frequency observed with $T_A=25^\circ\text{C}, V_{cc}=3.3V, O_{Load}=15\text{ pF}$.
	Aging Tolerance 1 Year	-0.8		+0.8	$\times 10^{-6}$	$T_A=25^\circ\text{C}, V_{cc}=3.3V$, and after 30 days of operation.
Aging Tolerance 10 Year	-2.5		+2.5	$\times 10^{-6}$		



Power Supply	Current Consumption			15	mA	@25°C, V _{cc} =3.3V, O _{Load} =15pF.
	Supply Voltage	3.13	3.3	3.47	V	
Phase Noise	Phase Noise		-65		dBc/Hz	1Hz
			-93			10Hz
			-118			100Hz
			-140			1KHz
			-154			10KHz
			-156			100KHz
Environmental Conditions	Operable Temperature	-40		+85	°C	
	Storage Temperature	-40		+90	°C	
	ESD Level	JESD22-A114F Class 1B; 10* 2000V				
	Moisture Sensitivity	Level 2				
	Vibration	MIL-STD-883 Meth 2007 Cond A 20G 20-2000Hz 4x in each 3axis 4 min				
	Shock	MIL-STD-202 Meth 213B Cond. F; 1500g 0.5ms 6 shocks in each direction				
	Solvent Resistance	MIL-STD-833 Meth 2015 Solv.1,3,4				
	Solderability	J_STD_002C Cond A, Through hole device/ Cond. B, SMD 255C(dicing time 50,5sec.) Dip + Look with 8h damp pre-treatment ;solder wetting>95%				
RoHS Compliance	100% ROHS Compliant					



2. Mechanical Structure(mm)

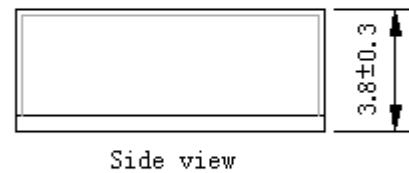
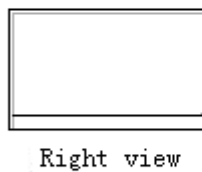
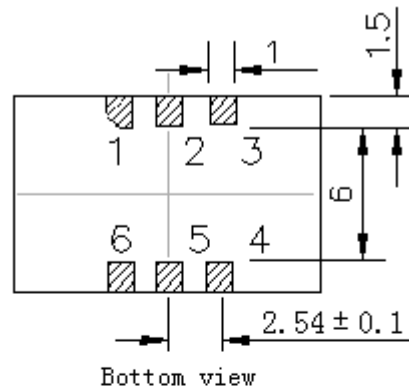
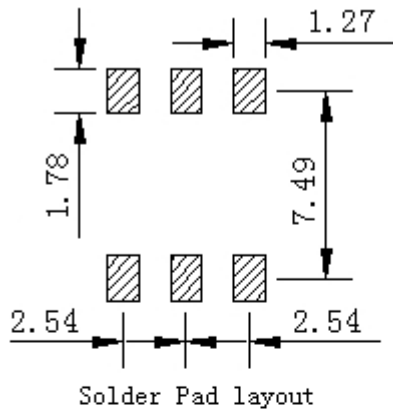

PIN FUNCTION

PIN	FUNCTION
1	NC
2,5	NC
3	GND
4	OUTPUT
6	VCC

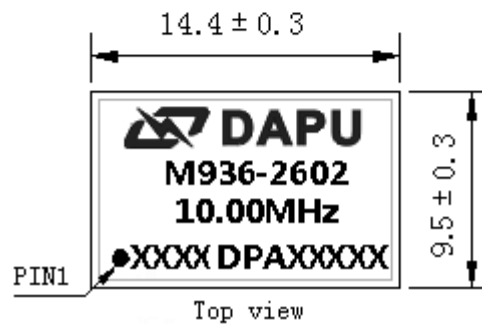

- Note1:** Tolerance $\pm 0.2\text{mm}$ without mark
- Note2:** The first two xx representative: week
After two xx representative: year
At last five Axxxxx representative: serial number
- Note3:** Referential weight 2g
- Note4:** NC is not connect



3. Test circuit

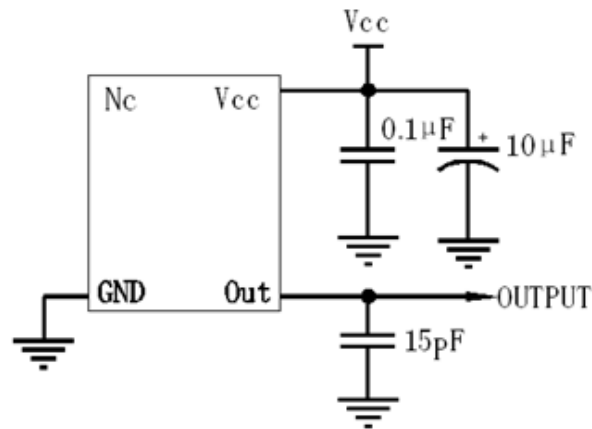

4. Reflow Soldering Curve (RoHS)

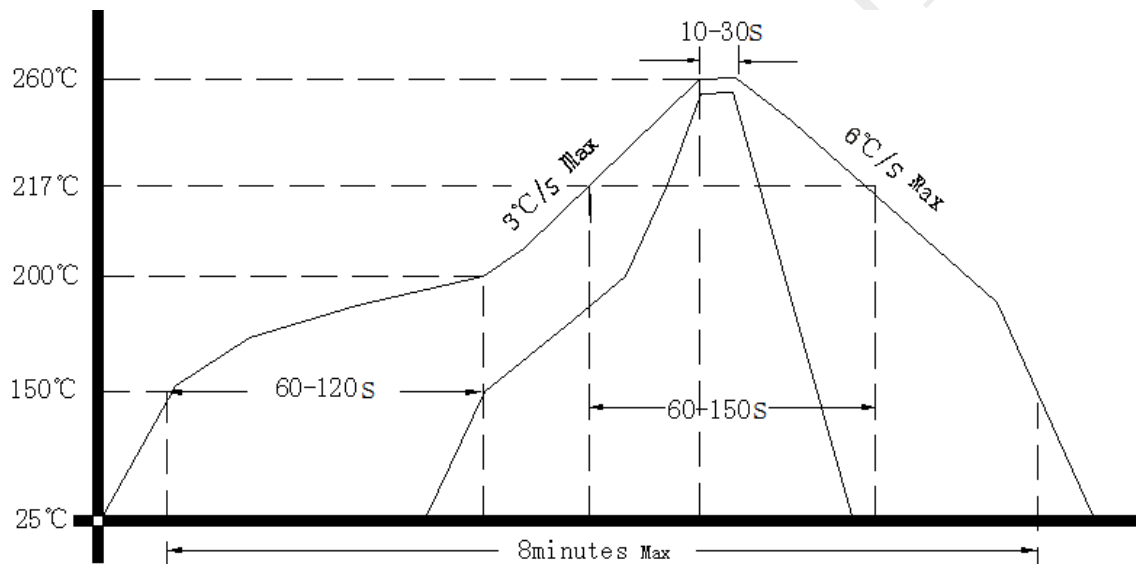

5. Package: Tape & Reel (mm)

