

Customer Code : _____

DATASHEET

DAPU P/N: **O11F-P319-20.00MHz**

Customer P/N: _____

DAPU			Customer Approval
Drew	Audited	Approved	Stamp, please! Thanks!
Date: 2016.06.21			

Guangdong Dapu Telecom Technology Co.,Ltd

Bldg 16,.N.Ind.Zone,SSL Industry Park, Dongguan City, Guangdong Province, China

TEL: 0086-0769-88010888 FAX: 0086-0769-81800098



1. Electrical Parameters

MODEL:O11F-P319-20.00MHZ						
Item	Description	Parameters			Unit	Test Condition
		Min.	Typ.	Max.		
Output	Frequency	20.00			MHz	
	Output Waveform	HCMOS				
	Output Low Voltage			0.4	V	$V_{cc}=3.3V, O_{load}=15pF$
	Output High Voltage	2.4			V	$V_{cc}=3.3V, O_{load}=15pF$
	Duty Cycle	45	50	55	%	@50%
	Rise / Fall Time (10%~90%)			10	ns	
	Load	15			pF	
Frequency Stabilities	Frequency Tolerance vs. Operating Temperature Range	-0.02		+0.02	$\times 10^{-6}$	T_A varied from $-40^{\circ}C$ to $85^{\circ}C$, measurement referenced to frequency observed with $f_{ref}=(f_{max}+f_{min})/2, V_{cc}=3.3V, O_{load}=15pF$, temperature variable speed less than $2^{\circ}C$ per minute.
	Initial Frequency Tolerance	-0.5		+0.5	$\times 10^{-6}$	Measurement referenced to frequency observed with $T_A=25^{\circ}C, V_{cc}=3.3V$, and after 15 minutes of operation, within 30 days after ex-works.
	Frequency Tolerance vs. Supply Voltage	-0.01		+0.01	$\times 10^{-6}$	measurement referenced to frequency observed $T_A=25^{\circ}C, V_{cc}$ varied from 3.13V to 3.47V, and $O_{Load}=15pF$.
	Frequency Tolerance vs. Load	-0.01		+0.01	$\times 10^{-6}$	5% load change measurement referenced to frequency observed with $T_A=25^{\circ}C, V_{cc}=3.3V$, and $O_{Load}=15pF$.
	Short-Term Stability: Allan Variance			0.1	$\times 10^{-9}$	Temperature stability, no EMI\EMC or other interference, test after power for 1hour ref. to $25^{\circ}C$; 1s, using PN9000 equipment.
	Aging Tolerance Per Day	-5		+5	$\times 10^{-9}$	V_{cc}, T_A constant measurement referenced to frequency observed with $T_A=25^{\circ}C, V_{cc}=3.3V$, and after 30 days of operation.
	Aging Tolerance 1 Year	-0.5		+0.5	$\times 10^{-6}$	



	Overall Stability	-4.6		+4.6	$\times 10^{-6}$	Inclusive of the following: - operating temperature -40°C to 85°C - 3.3V $\pm 5\%$ - 15pF load $\pm 5\%$ - Reflow soldering - 10 years aging reference to nominal frequency
Power Supply	Supply Voltage	3.13	3.3	3.47	V	
	Steady Consumption			300	mA	@25°C
	Warm up current			600	mA	
Phase Noise	Phase Noise		-100	-90	dBc/Hz	10Hz
			-130	-120		100Hz
			-150	-145		1KHz
			-150	-145		10KHz
			-150	-145		100KHz
			-155	-150		1MHz
Environmental Conditions	Operable Temperature	-40		+85	°C	
	Storage Temperature	-55		+105	°C	
	ESD Level	Human Body Model, class2: 2000V to 4000V; ANSI/ESDA/JEDEC JS-001-2010.				
		Machine Model, class B: 200V to 400V; ANSI/ESDA/JEDEC JS-001-2010.				
	Moisture Sensitivity Level	Level 2.				
	Vibration	Test Condition: 0.75mm ;acceleration:10g;10Hz~500Hz, one cycle per 30 min, test 2 hour. (3 times for each 3 directions X , Y , Z), IEC 68-2-06 Test Fc.				
Shock	50g; 11ms; half sine wave (3 times for each 3 directions X, Y, Z), IEC 68-2-27 Test Ea/Severity 50A.					
Full Package Storage	Relative humidity (%)	20%~70%				
	Temperature (°C)	-10~35°C				



2. Mechanical Structure (mm)

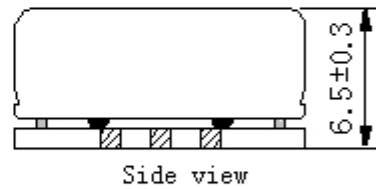
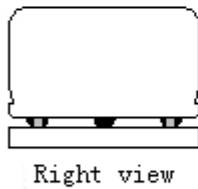
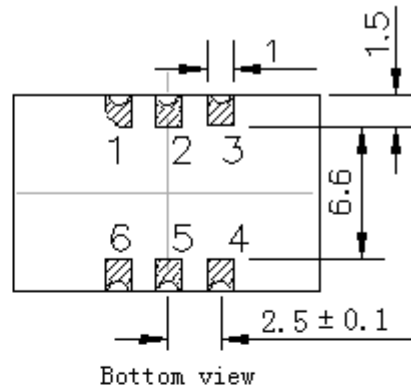
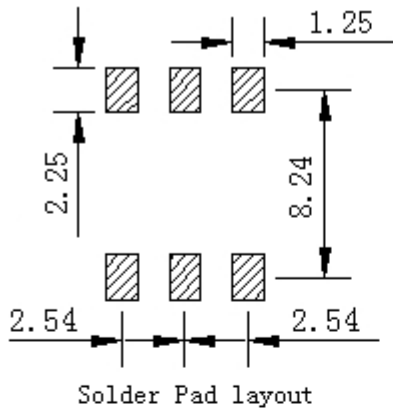

PIN FUNCTION

PIN	NOTATION	FUNCTION
1	NC	Not Connect
2,5	NC	Not Connect
3	GND	GND
4	OUTPUT	RF Output
6	VCC	Supply Voltage



- Note1:** Tolerance $\pm 0.20\text{mm}$ without mark
- Note2:** The first two xx representative: week
After two xx representative: year
- Note3:** Referential weight 2.2g
- Note4:** NC is not connect



3. Test Circuit

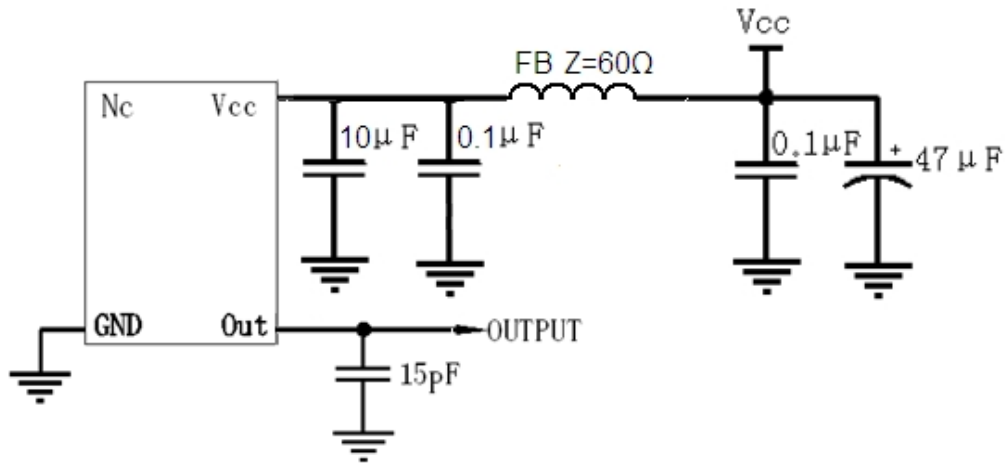

4. Reflow Soldering Curve (RoHS)

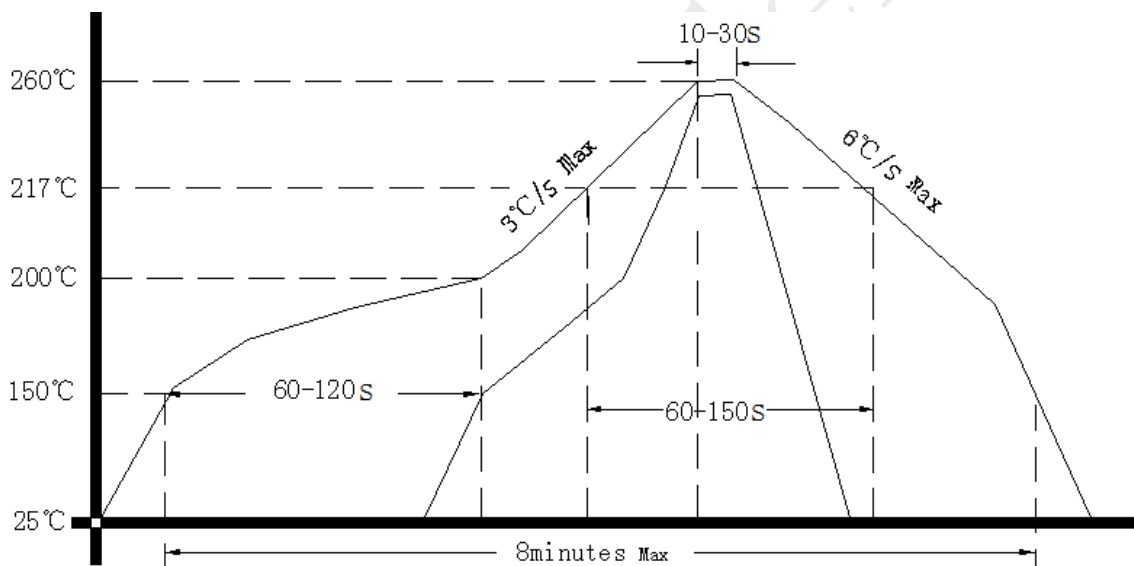

5. Package: Tape & Reel (mm)

