

Travelling Merchant: _____

DATASHEET

Standard: **O22B-E326-30.72MHz**

P/N: _____

Plot			The Label
Drew	Audited	Approved	Stamp, please! Thanks!
Date: 2016.12.07			

Guangdong Dapu Telecom Technology Co.,Ltd

Bldg13-16,.N.Ind.Zone,SSL Industry Park, Dongguan City, Guangdong Province, China

TEL: 0086-0769-88010888 FAX: 0086-0769-81800098



1. Electrical Parameters

MODEL: O22B-E326-30.72MHz						
Item	Description	Parameters			Unit	Test Condition
		Min.	Typ.	Max.		
Output	Frequency	30.72			MHz	
	Output Waveform	HCMOS				
	Output Low Voltage			0.4	V	$V_{cc}=5.0V, O_{load}=15pF$
	Output High Voltage	2.4			V	$V_{cc}=5.0V, O_{load}=15pF$
	Duty Cycle	45	50	55	%	@50%
	Rise / Fall Time (10%~90%)			10	ns	
	Load	15			pF	
Frequency Stabilities	Frequency Tolerance vs. Operating Temperature Range	-3		+3	$\times 10^{-9}$	T_A varied from $-20^{\circ}C$ to $70^{\circ}C$, measurement referenced to frequency observed with $f_{ref}=(f_{max}+f_{min})/2, V_{cc}=5.0V, V_c=2.5V, O_{load}=15pF$, temperature variable speed less than $2^{\circ}C$ per minute.
	Initial Frequency Tolerance	-0.05		+0.05	$\times 10^{-6}$	Measurement referenced to frequency observed with $T_A=25^{\circ}C, V_{cc}=5.0V, V_c=2.5V$, and after 15 minutes of operation, within 30 days after ex-works.
	Frequency Tolerance vs. Supply Voltage	-2		+2	$\times 10^{-9}$	measurement referenced to frequency observed $T_A=25^{\circ}C, V_{cc}$ varied from 4.75V to 5.25V, $V_c=2.5V$ and $O_{Load}=15pF$.
	Frequency Tolerance vs. Load	-2		+2	$\times 10^{-9}$	5% load change measurement referenced to frequency observed with $T_A=25^{\circ}C, V_{cc}=5.0V, V_c=2.5V$, and $O_{Load}=15pF$.
	Short-Term Stability: Allan Variance			0.01	$\times 10^{-9}$	Temperature stability, no EMI\EMC or other interference, test after power for 1hour ref. to $25^{\circ}C$; 1s, using PN9000 equipment.
	Aging Tolerance Per Day	-1		+1	$\times 10^{-9}$	V_{cc}, V_c, T_A constant measurement referenced to frequency observed with $T_A=25^{\circ}C, V_{cc}=5.0V, V_c=2.5V$, and after 30 days of operation.
	Aging Tolerance 1 Year	-0.1		+0.1	$\times 10^{-6}$	



Power Supply	Supply Voltage	4.75	5.0	5.25	V	
	Steady Consumption			500	mA	@25°C
	Warm up current			1000	mA	
Voltage Control Characteristics	Frequency Tuning Range	-0.8		-0.5	$\times 10^{-6}$	$V_c=0V$. measurement referenced to $V_c=2.5V$
		-0.05		+0.05	$\times 10^{-6}$	$V_c=2.5V$. measurement referenced to exactly 30.72MHz
		+0.5		+0.8	$\times 10^{-6}$	$V_c=5.0V$. measurement referenced to $V_c=2.5V$
	Linearity			10	%	
	Slope	Positive				
	Input Impedance	100			K Ω	
Phase Noise	Phase Noise		-110	-100	dBc/Hz	10Hz
			-130	-120		100Hz
			-140	-135		1KHz
			-145	-140		10KHz
			-150	-145		100KHz
			-150	-145		1MHz
Environmental Conditions	Operable Temperature	-20		+70	°C	
	Storage Temperature	-55		+105	°C	
	ESD Level	Human Body Model, class2: 2000V to 4000V; ANSI/ESDA/JEDEC JS-001-2010.				
		Machine Model, class B: 200V to 400V; ANSI/ESDA/JEDEC JS-001-2010.				
	Moisture Sensitivity Level	Not humidity sensitive.				
	Vibration	Test Condition: 0.75mm ;acceleration:10g;10Hz~500Hz, one cycle per 30 min, test 2 hour. (3 times for each 3 directions X , Y , Z), IEC 68-2-06 Test Fc.				
Shock	50g; 11ms; half sine wave (3 times for each 3 directions X, Y, Z), IEC 68-2-27 Test Ea/Severity 50A.					
Full Package Storage	Relative humidity (%)	20% ~70%				
	Temperature (°C)	-10~35°C				



2. Mechanical Structure (mm)

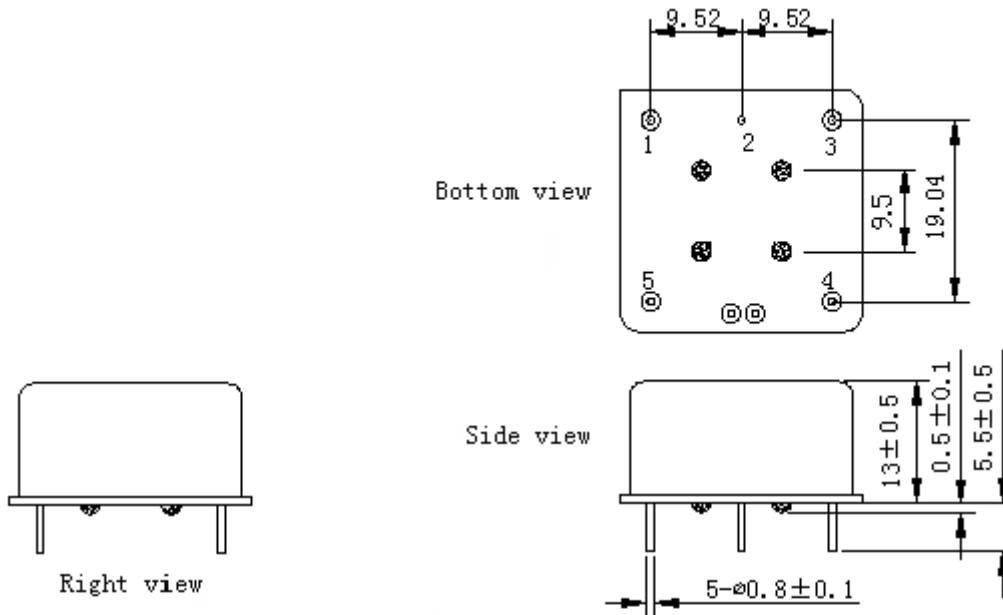

PIN FUNCTION

PIN	NOTATION	FUNCTION
1	OUTPUT	RF Output
2	GND	GND
3	VC	Control Voltage
4	NC	Not Connect
5	VCC	Supply Voltage

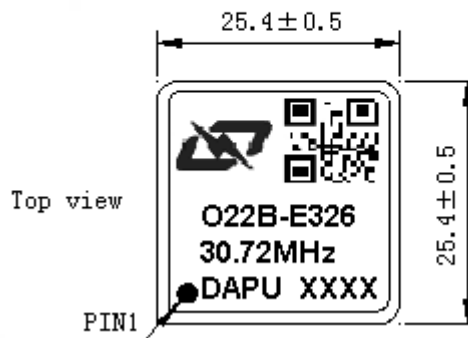

- Note1:** Tolerance ±0.2mm without mark
- Note2:** The first two xx representative: week
After two xx representative: year
- Note3:** Referential weight 13.6g
- Note4:** NC is not connect



3. Test Circuit

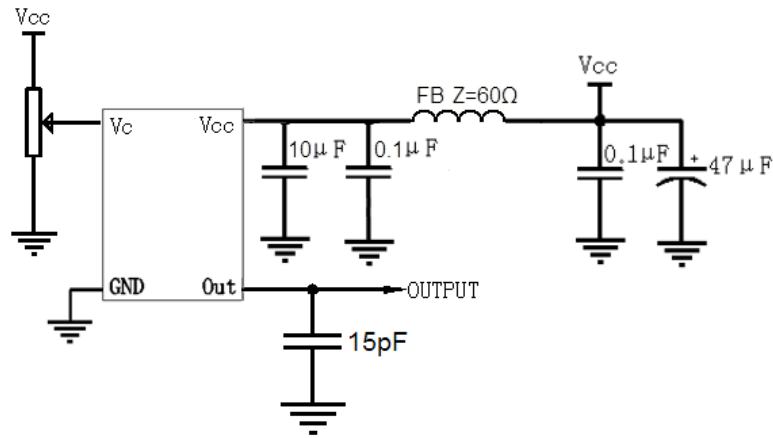

4. Reflow Soldering Curve (RoHS)



5. Package (mm)

