

Customer Code : _____

DATASHEET

DAPU P/N: DPBA15360001
Y75NNM15360

Plot			The Label
Drew	Audited	Approved	Stamp, please! Thanks!
Date: 2015.12.31			

Guangdong Dapu Telecom Technology Co.,Ltd

Bldg16,.N.Ind.Zone,SSL Industry Park, Dongguan City, Guangdong Province, China

TEL: 0086-0769-88010888 FAX: 0086-0769-81800098



1、 Electrical Parameters

MODEL: DPBA15360001							
No.	Parameters	SYM.	Electrical Spec.				Notes
			Min.	Typ.	Max.	Units	
1	Nominal Frequency	FL	153.60			MHz	
2	Output Waveform	-	LVPECL				
3	Supply Voltage	Vcc	3.135	3.3	3.465	V	
4	Rise/Fall Time (20%~80%)	-	-	-	0.5	ns	@25°C
5	Output Load	-	50Ω			-	Vcc-2V
6	Frequency Tolerance	-	-50	~	+50	×10 ⁻⁶	@25±3°C
7	Frequency Adjustment Range	-	-	-	±100	×10 ⁻⁶	Positive Slope
8	Frequency Control Voltage	-	1.65±1.65			V	
9	Operating Temperature Range	-	-40	~	+85	°C	
10	Storage Temperature	-	-40	~	+85	°C	
11	“1”Level Input Voltage	Vih	0.7Vcc	-	-	V	Pin2
12	“0”Level Input Voltage	Vil	-	-	0.3Vcc	V	
13	Output Disable Time	-	-	-	200	ns	
14	Output Enable Time	-	-	-	2	ms	
15	Current Consumption	-	-	-	50	mA	
16	Stand-by Current	-	-	-	30	uA	Pin1 “L” level
17	Output Level Logic 1	Voh	Vcc-1.025	~	Vcc-0.88	V	
18	Output Level Logic 0	Vol	Vcc-1.81	~	Vcc-1.62	V	
19	Duty Cycle	-	40	~	60	%	
20	Period Jitter	-	-	2.4	-	ps	σ
		-	-	22	-	ps	Peak to peak
21	Total Jitter	-	-	33	-	ps	tDJ + n × tRJ n=14.1(BER=1 × 10 ⁻¹²)(2)
22	Phase Jitter	-	-	-	1	ps	12KHz~20MHz
23	ESD Level	Human Body Model,class2: 2000V to 4000V; ANSI/ESDA/JEDEC JS-001-2010.					
		Machine Model, class B: 200V to 400V; ANSI/ESDA/JEDEC JS-001-2010.					
24	Moisture Sensitivity Level	Level 2.					
25	Vibration	Test Condition: 0.75mm ;acceleration:10g;10Hz~2000Hz, one cycle per 30 min, test 2 hour. (3 times for each 3 directions X , Y , Z) .IEC 68-2-06 Test Fc.					
26	Shock	100g; 6ms; half sine wave (3 times for each 3 directions X , Y , Z),IEC 68-2-27 Test Ea/Severity 50A.					
27	Full Package Storage	Relative humidity (%)				20%~70%	
		Temperature (°C)				-10~35°C	



2、Mechanical Structure(mm)

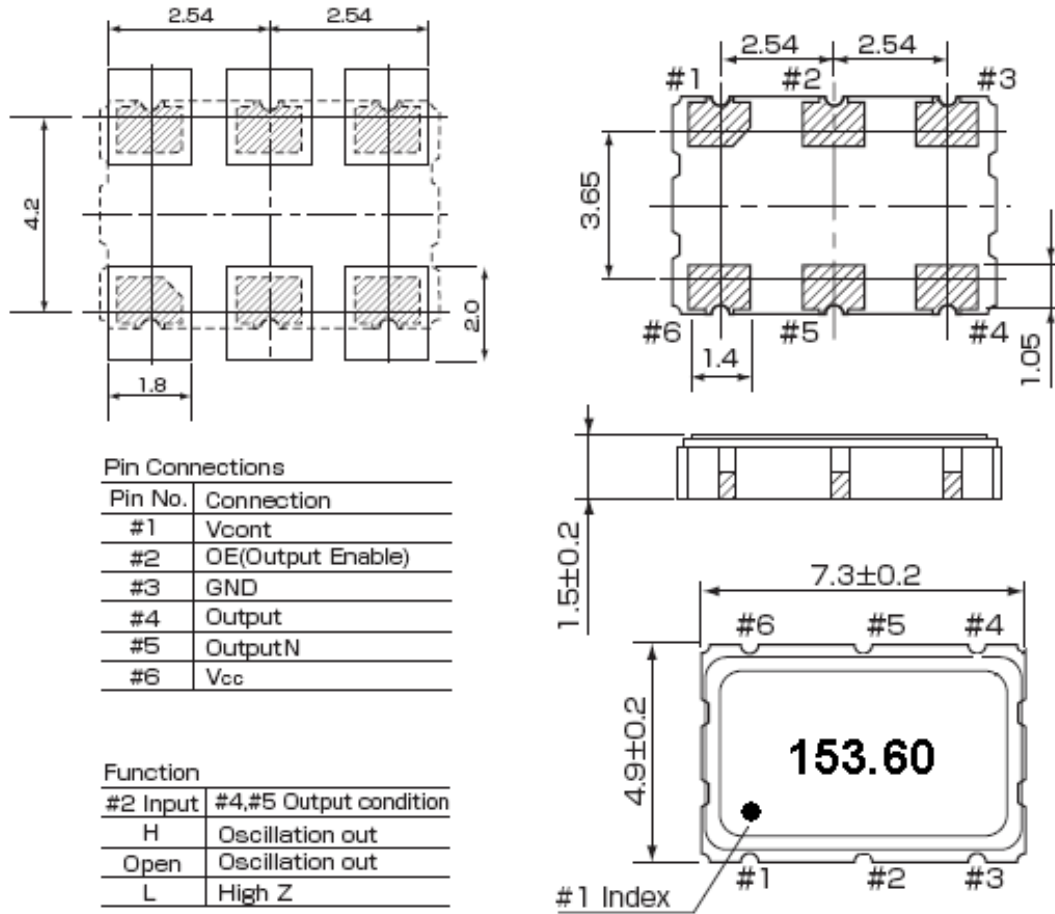

Note1: Tolerance $\pm 0.20\text{mm}$

3、Reflow Soldering Curve (RoHS)

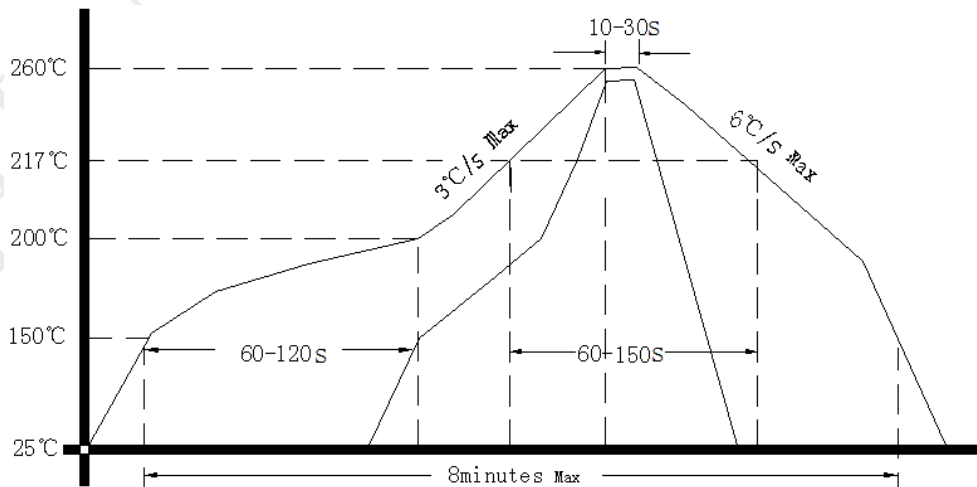

Note: If soldering with a hot air gun, ensure the temperature $< 320^{\circ}\text{C}$, soldering time < 15 seconds.



4、 Package: Tape & Reel (mm)

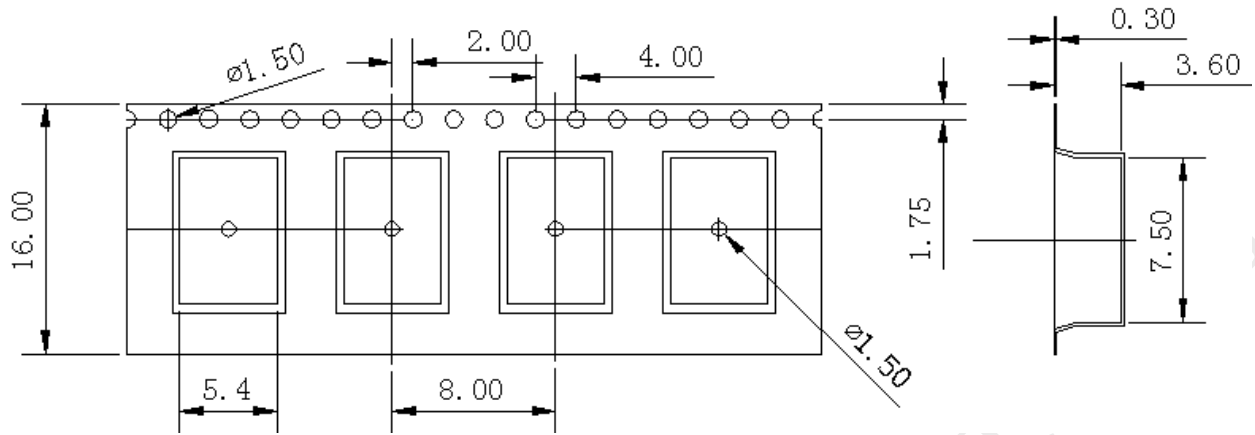

DAPU Confidential