

Customer Code : _____

DATASHEET

DAPU P/N : **O11F-Q311-20.00MHz**

Customer P/N: _____

DAPU			Customer Approval
Drew	Audited	Approved	Stamp, please! Thanks!
Date: 2021.09.10			

Guangdong Dapu Telecom Technology Co.,Ltd

Building 5, No.24, Industrial East Road, Songshanhu Park, Dongguan, Guangdong, P.R. China

TEL: 0086-0769-88010888 FAX: 0086-0769-81800098



Table of amendment

Version	Revision contents	Prepared by	Revised date
1.0	The first issued	<i>Amway</i>	2014.05.29
1.1	“Marking” change	<i>Amway</i>	2014.09.09
1.2	Modified the 1 st page “Warm-Up Time” and “Full Package Storage” added “Phase Noise” changed	<i>Amway</i>	2015.03.19
1.3	The “Mechanical Structure” changed	<i>Amway</i>	2018.06.21
1.4	The “Marking” changed	<i>Amway</i>	2018.08.06
1.5	The “Marking” changed	<i>Amway</i>	2021.09.10



1. Electrical Parameters

MODEL: O11F-Q311-20.00MHz						
Item	Description	Parameters			Unit	Test Condition
		Min.	Typ.	Max.		
Output	Frequency	20.00			MHz	
	Output Waveform	HCMOS				
	Output Low Voltage			0.4	V	$V_{cc}=3.3V, O_{load}=15pF$
	Output High Voltage	2.4			V	$V_{cc}=3.3V, O_{load}=15pF$
	Duty Cycle	45	50	55	%	@50%
	Rise / Fall Time (10%~90%)			8	ns	
	Load	15			pF	
Frequency Stabilities	Frequency Tolerance vs. Operating Temperature Range	-0.02		+0.02	$\times 10^{-6}$	T_A varied from $-40^{\circ}C$ to $85^{\circ}C$, measurement referenced to frequency observed with $f_{ref}=(f_{max}+f_{min})/2, V_{cc}=3.3V, V_c=1.65V, O_{load}=15pF$, temperature variable speed less than $2^{\circ}C$ per minute.
	Initial Frequency Tolerance	-0.5		+0.5	$\times 10^{-6}$	Measurement referenced to frequency observed with $T_A=25^{\circ}C, V_{cc}=3.3V, V_c=1.65V$, and after 15 minutes of operation, within 30 days after ex-works.
	Frequency Tolerance vs. Supply Voltage	-0.01		+0.01	$\times 10^{-6}$	measurement referenced to frequency observed $T_A=25^{\circ}C, V_{cc}$ varied from 3.13V to 3.47V, $V_c=1.65V$ and $O_{Load}=15pF$.
	Frequency Tolerance vs. Load	-0.01		+0.01	$\times 10^{-6}$	5% load change measurement referenced to frequency observed with $T_A=25^{\circ}C, V_{cc}=3.3V, V_c=1.65V$, and $O_{Load}=15pF$.
	Short-Term Stability: Allan Variance			0.1	$\times 10^{-9}$	Temperature stability, no EMI\EMC or other interference, test after power for 1hour ref. to $25^{\circ}C$; 1s, using PN9000 equipment.
	Aging Tolerance Per Day	-5		+5	$\times 10^{-9}$	V_{cc}, V_c, T_A constant measurement referenced to frequency observed with $T_A=25^{\circ}C, V_{cc}=3.3V, V_c=1.65V$, and after 30 days of operation.
	Aging Tolerance 1 Year	-0.5		+0.5	$\times 10^{-6}$	



Power Supply	Supply Voltage	3.13	3.3	3.47	V	
	Steady Consumption			250	mA	@25°C
	Warm up current			560	mA	
	Warm-Up Time			5	minutes	@25°C within $\pm 0.1 \times 10^{-6}$ of final frequency with reference after 1 hour on.
Voltage Control Characteristics	Frequency Tuning Range	-8		-3	$\times 10^{-6}$	$V_c=0V$. measurement referenced to $V_c=1.65V$
		-0.5		+0.5	$\times 10^{-6}$	$V_c=1.65V$. measurement referenced to exactly 20.00MHz
		+3		+8	$\times 10^{-6}$	$V_c=3.3V$. measurement referenced to $V_c=1.65V$
	Linearity			10	%	
	Slope	Positive				
	Input Impedance	100			K Ω	
Phase Noise	Phase Noise @25°C		-100	-90	dBc/Hz	10Hz
			-130	-120		100Hz
			-150	-145		1KHz
			-150	-145		10KHz
			-150	-145		100KHz
			-155	-150		1MHz
Environmental Conditions	Operable Temperature	-40		+85	°C	
	Storage Temperature	-55		+105	°C	
	ESD Level	Human Body Model, class2: 2000V to 4000V; ANSI/ESDA/JEDEC JS-001-2010.				
		Machine Model, class B: 200V to 400V; JEDEC JESD22-A115C.				
	Moisture Sensitivity Level	Level 2.				
	Vibration	Test Condition: 0.75mm ;acceleration:10g;10Hz~500Hz, one cycle per 30 min, test 2 hour. (3 times for each 3 directions X , Y , Z), IEC 68-2-06 Test Fc.				
Shock	50g; 11ms; half sine wave (3 times for each 3 directions X, Y, Z), IEC 68-2-27 Test Ea/Severity 50A.					
Full Package Storage	Relative humidity (%)	20% ~70%				
	Temperature (°C)	-10~35°C				



2. Mechanical Structure (mm)

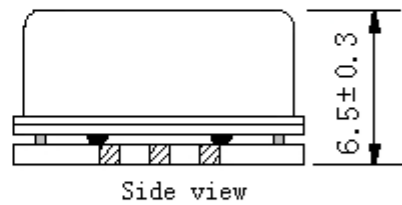
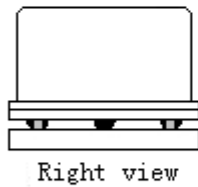
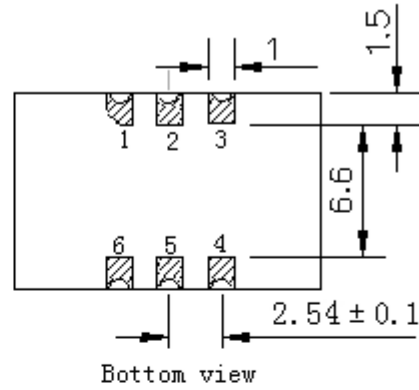
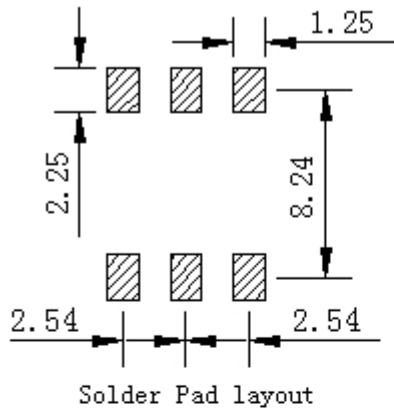

PIN FUNCTION

PIN	NOTATION	FUNCTION
1	VC	Control Voltage
2,5	NC	Not Connect
3	GND	GND
4	OUTPUT	RF Output
6	VCC	Supply Voltage

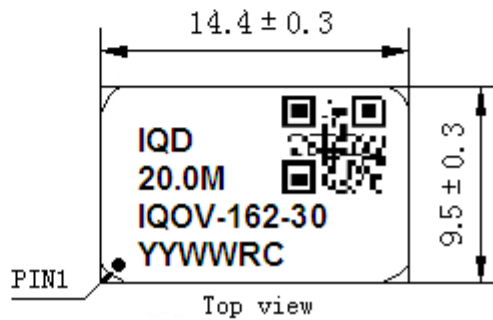

Note1: Tolerance ± 0.2 mm without mark

Note2: The YY representative: year
The WW representative: week

Note3: Referential weight 2.2g

Note4: NC is not connect



3. Test Circuit

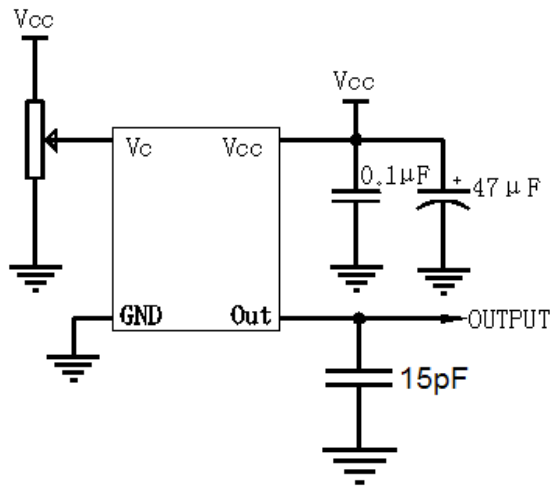

4. Reflow Soldering Curve (RoHS)

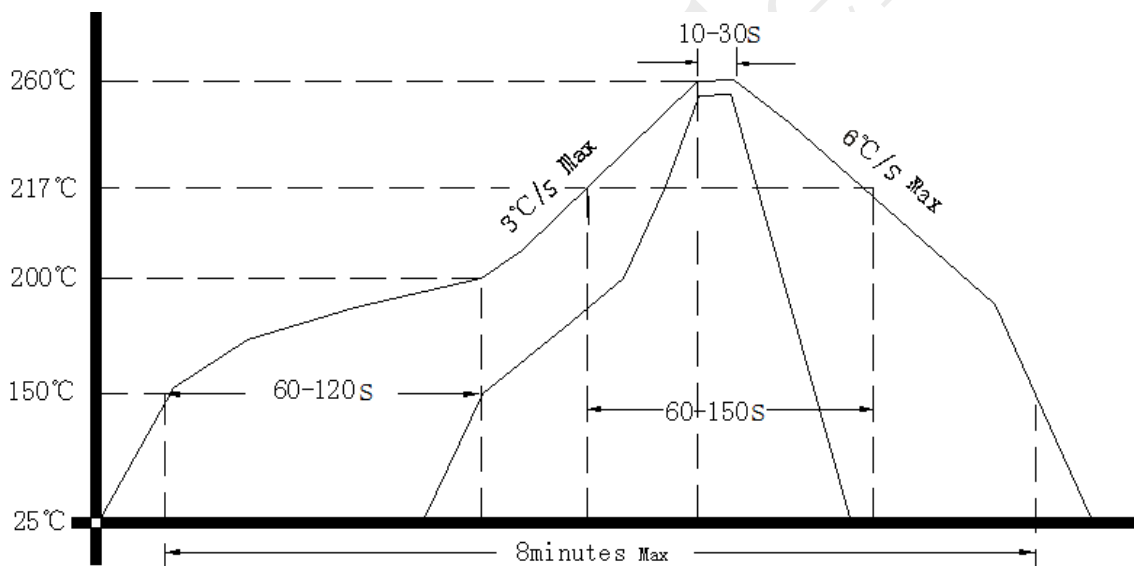

5. Package: Tape & Reel (mm)

