

Customer Code:

DATASHEET

DAPU P/N: CM22B-E328-10.00MHz

Customer P/N: _____

DAPU			Customer Approval
Drew	Audited	Approved	Stamp, please! Thanks!
Date: 2021.10.25			

Guangdong Dapu Telecom Technology Co., Ltd

Building 5, No.24, Industrial East Road, Songshanhu Park, Dongguan, Guangdong, P.R. China

TEL: 0086-0769-88010888 FAX: 0086-0769-81800098



Table of Amendment

Version	Revision contents	Prepared by	Revised date
1.0	First issued	<i>Amway</i>	2020.06.24
1.1	Update the “5 hours holdover” capability to +/-10 us after power up and locking to the reference for 25 minutes	<i>Amway</i>	2020.07.10
1.2	Update LVCMOS input parameters; Add ToD output format; Add 1pps input requirements	<i>Amway</i>	2021.10.25

DAPU

Confidential



Table of Contents

1	GENERAL DESCRIPTION	4
2	PIN DEFINITION	5
3	ELECTRICAL PARAMETERS.....	5
4	PERFORMANCE.....	6
5	UART	7
6	CONTROL PINS.....	8
7	ENVIRONMENTAL CONDITIONS	9
8	TYPICAL APPLICATION	10
9	MECHANICAL STRUCTURE (MM)	11
10	WAVE SOLDERING CURVE (ROHS).....	12
11	PACKAGE (MM)	12

DAPU

Confidential



1 General Description

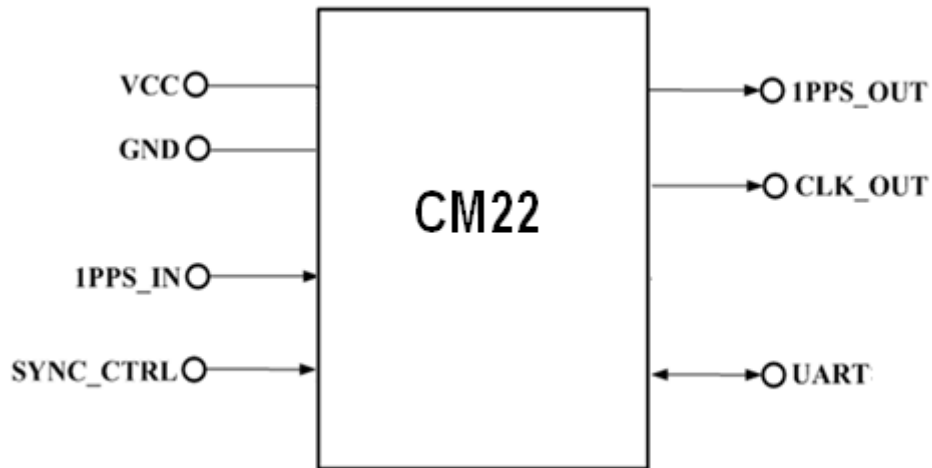

Figure 1 CM22

Figure 1 is the basic diagram of CM22. CM22 is a high-performance clock module designed to provide precise frequency and phase synchronizing with external time reference for telecom and other applications.

Key features:

- **Reference:** 1PPS and TOD from GNSS receiver, IEEE1588 etc.
- **Temperature Stability:** $\pm 0.2\text{ppb}(-40^{\circ}\text{C}-85^{\circ}\text{C})$
- **Holdover:** $\pm 10\mu\text{s}/24\text{H}$, after locking 2H
- **Clocks Input and Output:** 1*1PPS input, 1*1PPS output and 1*10MHz output
- **Serial Interface:** 1*UART for management and ToD In/Output
- **Mechanical Size:** 20.2mm*20.2mm*13.0mm



2 Pin Definition

Table 1 Pin Definition

Pin group	Pin#	Pin Name	Type	Description
Supply Voltage	2	VCC	PWR	Power Supply
	3	GND	GND	Ground
Control and Status Pins	1	SYNC_CTRL	I	Synchronization Procedure Control
UART	5	RXD	I	Asynchronous Serial Data Output/Input
	6	TXD	O	
Input Clock	4	1PPS_IN	I	1PPS Reference Input.
Output Clocks	7	1PPS_OUT	O	1PPS Output
	8	CLK_OUT	O	10.00MHz Output

3 Electrical Parameters

Table 2 Electrical Parameters

Parameter	Symbol	Minimum	Typical	Maximum	Units
LVC MOS Input					
High Level Input Voltage	V_{IH}	2.0			V
Low Level Input Voltage	V_{IL}			0.8	V
LVC MOS Output					
High Level Output Voltage	V_{OH}	2.4			V
Low Level Output Voltage	V_{OL}			0.4	V



4 Performance

Table 3 Performance

Item	Parameter	Minimum	Typical	Maximum	Units	Test Condition	
Clock Output	Nominal Frequency	10.00			MHz	Synchronizing with 1PPS reference.	
	Duty Cycle	45	50	55	%	Load 15pF	
	Frequency vs. Temperature	-0.2		+0.2	$\times 10^{-9}$	$V_{CC}=3.3V$; $O_{load}=15pF$; T_A varies from $-40^{\circ}C$ to $85^{\circ}C$, temperature slope less than $2^{\circ}C$ per minute.	
	Accuracy	-5		+5	$\times 10^{-12}$	24 hours average value when locked to 1PPS.	
	Short-term Stability	-0.01		+0.01	$\times 10^{-9}$	$V_{CC}=3.3V$; $T_A=25^{\circ}C$; 1s; no EMI/EMC or other interference.	
	Daily Aging	-0.5		+0.5	$\times 10^{-9}$	$V_{CC}=3.3V$; $T_A=25^{\circ}C$.	
	Yearly Aging	-0.03		+0.03	$\times 10^{-6}$		
	Phase Noise			-110	-100	dBc/Hz	10Hz
				-143	-138		100Hz
				-155	-150		1KHz
			-155	-150	10KHz		
			-155	-150	100KHz		
			-160	-155	1MHz		
1 PPS Input	Waveform	LVCMOS					
	Pulse Width	0.001	100	500	ms		
	Pulse Width	0.001	100	500	ms		
1 PPS Output	Waveform	LVCMOS					
	Pulse Width	0.001	100	500	ms		
	Accuracy	-50		+50	ns	Synchronizing with 1PPS reference.	
	24 hours holdover	-10		+10	μs	$\Delta T = \pm 5^{\circ}C$, 24 hours holdover after locking 2 hours; temperature slope less than	



						2°C per minute.
	5 hours holdover	-10		+10	us	$\Delta T = \pm 5^\circ\text{C}$, 5 hours holdover after locking 25 minutes; temperature slope less than 2°C per minute.
Supply Voltage	Supply Voltage	3.135	3.3	3.465	V	
	Warm Up Current			750	mA	
	Steady Current			300	mA	@25°C
	AC Ripple			50	mVpk-pk	10Hz to 1MHz

5 UART

UART interfaces are used for management and TOD, which has a fixed baud rate (115200) using 1 stop bit and no parity. It is a LVTTTL-compatible port and needs an external translator to work with other signal types (such as RS-232C or RS-485).

a) TOD input sentence format

\$GPZDA, <1>,<2>,<3>,<4>,<5>,<6>*HH<CR><LF>

Parameter Number	Parameter Name	Format	Description
<1>	UTC time	hhmmss.ss	Hour, minute, second, 9 characters
<2>	day	dd	Range: 01~31, 2 characters
<3>	month	mm	Range: 01~12, 2 characters
<4>	year	yyyy	4 characters
<5>	NA	00	Filled with 00
<6>	NA	00	Filled with 00

Note: All sentences begin with "\$" , end with<CR><LF>
 * HH represents the bitwise XOR result of all characters between "\$" and "*" <CR><LF>: Carriage Return and Line Feed.
 Example: \$GPZDA,010516.00,26,11,2008,00,00*6B

b) TOD output sentence format

\$DPZDA, <1>,<2>,<3>,<4>,<5>,<6>,<7>,<8>,<9>,<10>,<11>,<12>,<13>,<14>*HH<CR><LF>

Parameter Number	Parameter Name	Format	Description
<1>	UTCtime	hhmmss	Hour,minute,second, 6 characters
<2>	Day	dd	Range: 01~31, 2 characters
<3>	Month	mm	Range: 01~12, 2 characters
<4>	Year	yyyy	4 characters



<5>	System state	xx	00-Freerun, 01-fast track, 10-lock, 11-holdover
<6>	Lock indicator	x	0-unlock, 1-locked
<7>	temperature	xxx	Unit: 0.1℃。 e.g.234means23.4℃
<8>	Input identifier	x	1-1PPS Input, 0-no1PPS Input.
<9>	GPZDA input identifier	x	1 means GPZDA Input, 0 means no GPZDA Input.
<10>	reserve	0	--
<11>	T1	xxxxxx	Test parameter1: range +8192~-8192, 5 parameters.
<12>	T2	xxxxxxxxxx	Test parameter2: range 65535.0000~00000.0000, 10 parameters
<13>	T3	xxxxxxxxxx	Test parameter3: 10 parameters
<14>	reserve	xxxxxxx	7 characters
<p>Note: All sentences begin with "\$" , end with<CR><LF> * HH represents the bitwise XOR result of all characters between "\$" and "*" <CR><LF>: Carriage Return and Line Feed. Example: \$DPZDA,010517,26,11,2008,10,1,315,1,1,0,-0000,31945.0000,-0000.1146,0000000*78</p>			

6 Control Pins

CM22 is a clock module which synchronizes the local clock to reference such as 1 PPS retrieving from GPS. CM22 will work normally performing synchronizing algorithm when the SYNC_CTRL pin is driven high. It also could be forced to work in free-run or holdover status when the SYNC_CTRL pin is driven low.



7 Environmental Conditions

Table 5 Environmental Conditions

Parameter	Conditions	
Operating Temperature	-40°C to 85°C	
Storage Temperature	-55°C to 105°C	
Storage Humidity	30%~80%	
ESD Level	Human Body Model, class2: 2000V to 4000V; ANSI/ESDA/JEDEC JS-001-2010.	
	Machine Model, class B: 200V to 400V; JEDEC JESD22-A115C.	
Moisture Sensitivity Level	Not humidity sensitive.	
Vibration	Test Condition: 0.75mm ;acceleration:10g;10Hz~500Hz, one cycle per 30 min, test 2 hour. (3 times for each 3 directions X, Y, Z), IEC 68-2-06 Test Fc.	
Shock	50g; 11ms; half sine wave (3 times for each 3 directions X, Y, Z), IEC 68-2-27 Test Ea/Severity 50A.	
Relative Humidity	20%~70%	Full Package Storage
Temperature	-10°C~35°C	



8 Typical Application

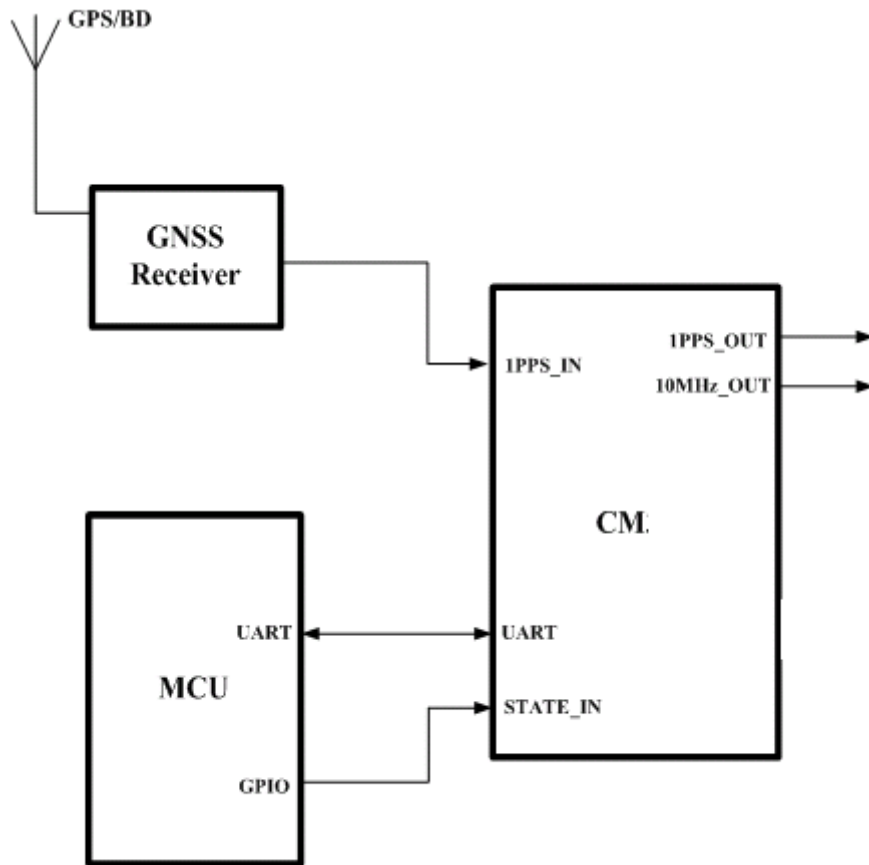

GNSS Receiver offers 1PPS signal to CM22.
The MCU monitors the work state of CM22.



9 Mechanical Structure (mm)

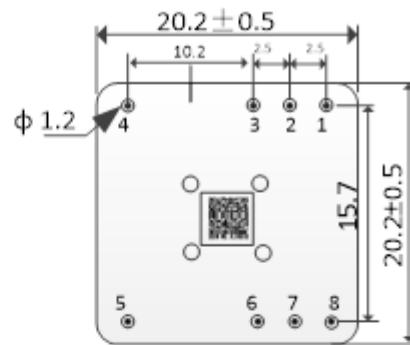

Bottom View

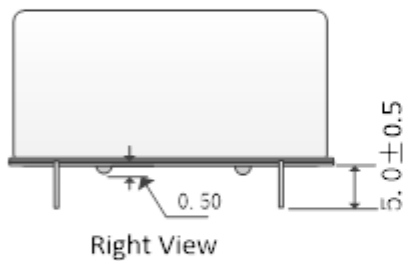

Right View

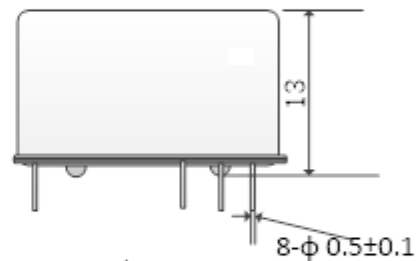

Side View

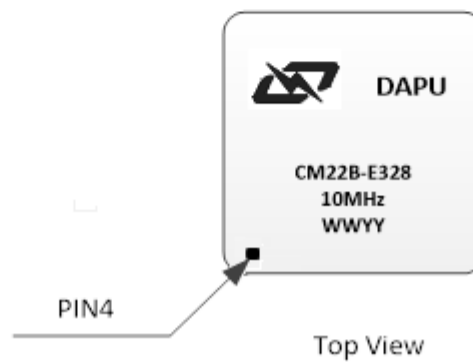

Top View

Note1: Tolerance ± 0.3 mm without mark.

Note2: WW represents Week.

YY represents Year.



10 Wave Soldering Curve (RoHS)

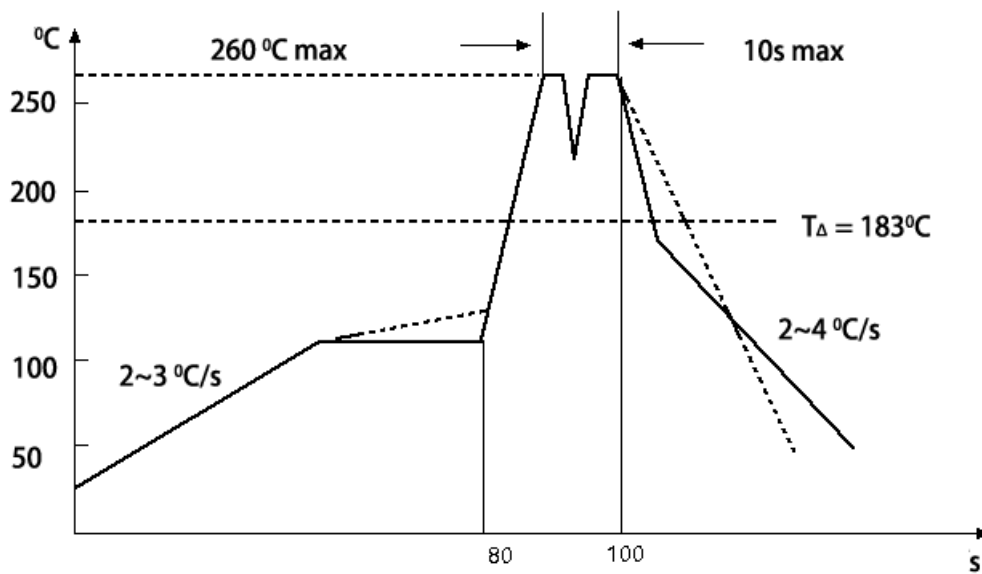

11 Package (mm)

