

Customer Code : _____

DATASHEET

DAPU P/N: **O11F-Q319-25.00MHz-G035**

Customer P/N: _____

| DAPU | | | Customer Approval |
|------------------|---------|----------|------------------------|
| Drew | Audited | Approved | Stamp, please! Thanks! |
| | | | |
| Date: 2022.04.28 | | | |

Guangdong Dapu Telecom Technology Co.,Ltd

Building 5, No.24, Industrial East Road, Songshanhu Park, Dongguan, Guangdong, P.R. China

TEL: 0086-0769-88010888 FAX: 0086-0769-81800098



Table of amendment

| Version | Revision contents | Prepared by | Revised date |
|---------|-------------------|--------------|--------------|
| 1.0 | The first issued | <i>Amway</i> | 2022.04.28 |
| | | | |
| | | | |
| | | | |
| | | | |
| | | | |
| | | | |
| | | | |
| | | | |
| | | | |
| | | | |
| | | | |
| | | | |
| | | | |
| | | | |
| | | | |
| | | | |
| | | | |



1. Electrical Parameters

| MODEL: O11F-Q319-25.00MHZ-G035 | | | | | | |
|--------------------------------|---|------------|------|-------|------------------|---|
| Item | Description | Parameters | | | Unit | Test Condition |
| | | Min. | Typ. | Max. | | |
| Output | Frequency | 25.00 | | | MHz | |
| | Output Waveform | HCMOS | | | | |
| | Output Low Voltage | | | 0.4 | V | $V_{cc}=3.3V, O_{load}=15pF$ |
| | Output High Voltage | 2.4 | | | V | $V_{cc}=3.3V, O_{load}=15pF$ |
| | Duty Cycle | 45 | 50 | 55 | % | @50% |
| | Rise / Fall Time (10%~90%) | | | 10 | ns | |
| | Load | 15 | | | pF | |
| Frequency Stabilities | Frequency Tolerance vs. Operating Temperature Range | -0.02 | | +0.02 | $\times 10^{-6}$ | T_A varied from $-40^{\circ}C$ to $85^{\circ}C$, measurement referenced to frequency observed with $f_{ref}=(f_{max}+f_{min})/2, V_{cc}=3.3V, O_{load}=15pF$, temperature variable speed less than $2^{\circ}C$ per minute. |
| | Initial Frequency Tolerance | -0.5 | | +0.5 | $\times 10^{-6}$ | Measurement referenced to frequency observed with $T_A=25^{\circ}C, V_{cc}=3.3V$, and after 15 minutes of operation, within 30 days after ex-works. |
| | Frequency Tolerance vs. Supply Voltage | -5 | | +5 | $\times 10^{-9}$ | measurement referenced to frequency observed $T_A=25^{\circ}C, V_{cc}$ varied from 3.13V to 3.47V, and $O_{Load}=15pF$. |
| | Frequency Tolerance vs. Load | -5 | | +5 | $\times 10^{-9}$ | 5% load change measurement referenced to frequency observed with $T_A=25^{\circ}C, V_{cc}=3.3V$, and $O_{Load}=15pF$. |
| | Short-Term Stability: Allan Variance | | | 0.1 | $\times 10^{-9}$ | Temperature stability, no EMI\EMC or other interference, test after power for 1hour ref. to $25^{\circ}C; 1s$. |
| | Aging Tolerance Per Day | -5 | | +5 | $\times 10^{-9}$ | V_{cc}, V_c, T_A constant measurement referenced to frequency observed with $T_A=25^{\circ}C, V_{cc}=3.3V$, and after 30 days of operation. |
| | Aging Tolerance 1 Year | -0.5 | | +0.5 | $\times 10^{-6}$ | |
| | Aging Tolerance 20 Years | -4.6 | | +4.6 | $\times 10^{-6}$ | |
| Power Supply | Supply Voltage | 3.13 | 3.3 | 3.47 | V | |
| | Steady Consumption | | | 300 | mA | @ $25^{\circ}C$ |
| | Warm up current | | | 600 | mA | |
| | Warm-Up Time | | | 3 | min | @ $25^{\circ}C$ within $\pm 0.02 \times 10^{-6}$ of final frequency with reference after 1 hour on. |



| | | | | | | |
|--------------------------|--|--|------|------|--------|--------|
| Phase Noise | Phase Noise | | -100 | -90 | dBc/Hz | 10Hz |
| | | | -130 | -120 | | 100Hz |
| | | | -145 | -140 | | 1KHz |
| | | | -150 | -145 | | 10KHz |
| | | | -150 | -145 | | 100KHz |
| | | | -155 | -150 | | 1MHz |
| Environmental Conditions | Operable Temperature | -40 | | +85 | °C | |
| | Storage Temperature | -55 | | +105 | °C | |
| | ESD Level | Human Body Model, class2: 2000V to 4000V; ANSI/ESDA/JEDEC JS-001-2010. | | | | |
| | | Machine Model, class B: 200V to 400V; JEDEC JESD22-A115C. | | | | |
| | Moisture Sensitivity Level | Level 2. | | | | |
| | Vibration | Test Condition: 0.75mm ;acceleration:10g;10Hz~500Hz, one cycle per 30 min, test 2 hour. (3 times for each 3 directions X ,Y , Z), IEC 68-2-06 Test Fc. | | | | |
| Shock | 50g; 11ms; half sine wave (3 times for each 3 directions X, Y, Z), IEC 68-2-27 Test Ea/Severity 50A. | | | | | |
| Full Package Storage | Relative humidity (%) | 20%~70% | | | | |
| | Temperature (°C) | -10~35°C | | | | |



2. Mechanical Structure (mm)

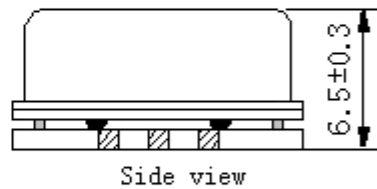
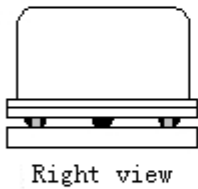
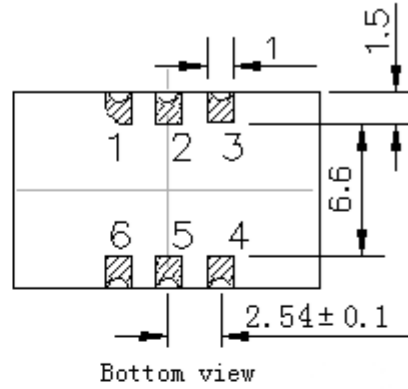
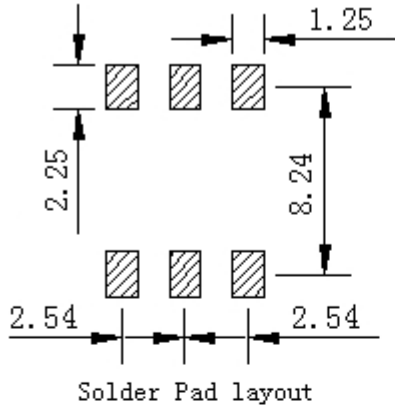

PIN FUNCTION

| PIN | NOTATION | FUNCTION |
|-----|----------|----------------|
| 1 | NC | Not Connect |
| 2,5 | NC | Not Connect |
| 3 | GND | GND |
| 4 | OUTPUT | RF Output |
| 6 | VCC | Supply Voltage |

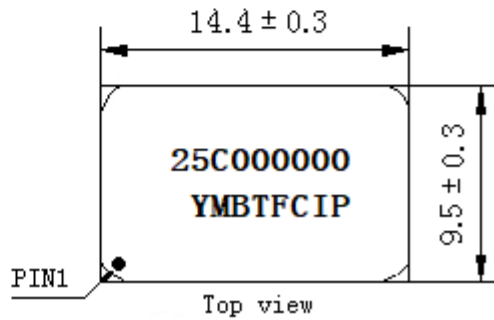

Note1: Tolerance $\pm 0.20\text{mm}$ without mark

Note2: Y--- YEAR

2022->2 2023->3 2024->4

M--- MONTH

Jan->1 Feb->2 Mar->3 Apr->4 May->5 Jun->6 Jul->7 Aug->8 Sep->9 Oct->A Nov->B Dec->C

Note3: Referential weight 1.5g

Note4: NC is not connect



3. Test Circuit

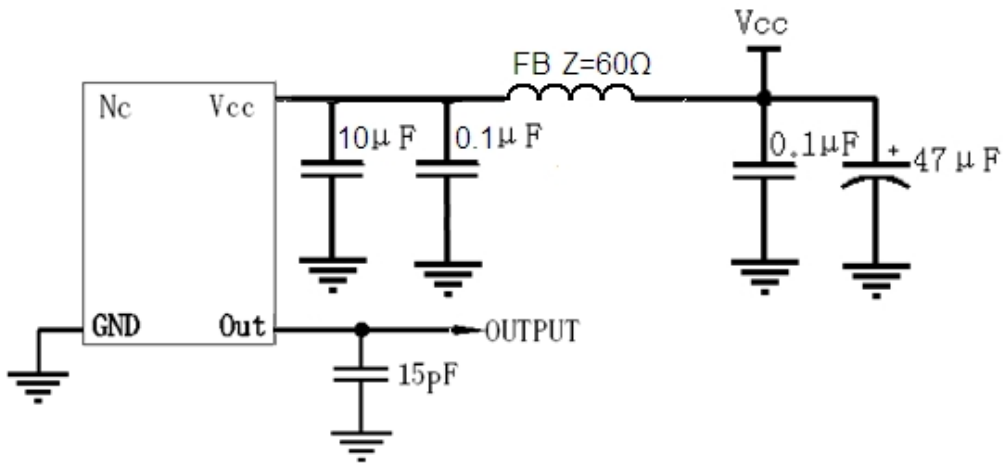

4. Reflow Soldering Curve (RoHS)

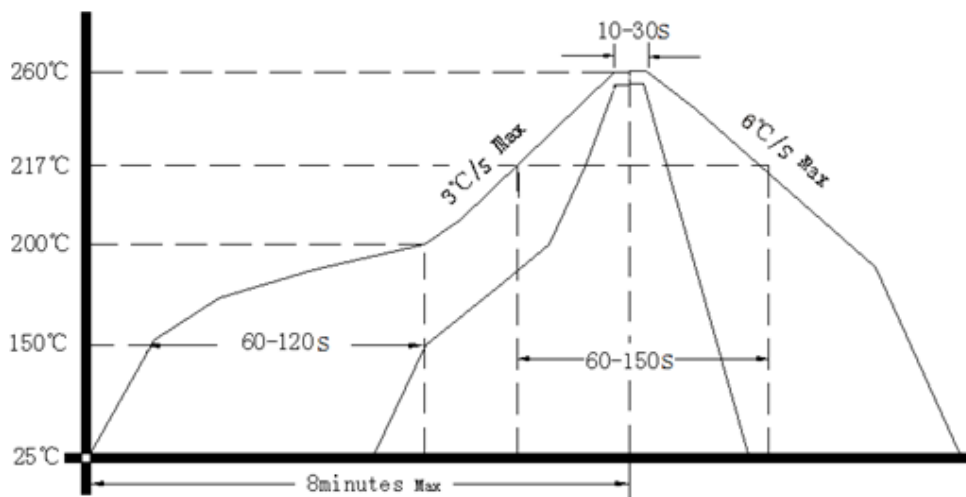

Note: Passing through reflow upside down is not supported

5. Package: Tape & Reel (mm)

