

Travelling Merchant: _____

DATASHEET

Standard: T75A-P313-10.00MHz-G301

P/N: _____

Plot			The Label
Drew	Audited	Approved	Stamp, please! Thanks!
Date: 2023.08.15			

Guangdong Dapu Telecom Technology Co.,Ltd

Building 5, No.24, Industrial East Road, Songshanhu Park, Dongguan, Guangdong, P.R. China

TEL: 0086-0769-88010888 FAX: 0086-0769-81800098



1. Electrical Parameters

MODEL: T75A-P313-10.00MHz-G301						
Item	Description	Parameters			Unit	Test Condition
		Min.	Typ.	Max.		
Output	Frequency	10.00			MHz	
	Output Waveform	HCMOS				
	Output Low Voltage			0.33	V	$V_{cc}=3.3V, O_{load}=15\text{ pF}$
	Output High Voltage	2.97			V	$V_{cc}=3.3V, O_{load}=15\text{ pF}$
	Duty Cycle	45	50	55	%	@50%
	Rise / Fall Time (10%~90%)			8	ns	@25°C
	Start time			5	ms	
	Harmonics			-5	dBc	
	Load	15			pF	
Frequency Stabilities	Frequency Tolerance vs. Operating Temperature Range	-0.28		+0.28	$\times 10^{-6}$	T_A varied from -40°C to 85°C, measurement referenced to frequency observed with $f_{ref}=(f_{max}+f_{min})/2, V_{cc}=3.3V, V_c=1.5V, O_{load}=15\text{ pF}$, temperature variable speed less than 2°C per minute.
	Nominal Frequency Tolerance	-2		+2	$\times 10^{-6}$	Measurement referenced to frequency observed with $T_A=25^\circ\text{C}$ after 2 Reflows.
	Frequency Tolerance vs. Supply Voltage	-0.1		+0.1	$\times 10^{-6}$	measurement referenced to frequency observed $T_A=25^\circ\text{C}, V_{cc}$ varied from 3.13V to 3.47V and $V_c=1.5V, O_{Load}=15\text{ pF}$.
	Frequency Tolerance vs. Load	-0.1		+0.1	$\times 10^{-6}$	5% load change measurement referenced to frequency observed with $T_A=25^\circ\text{C}, V_{cc}=3.3V, V_c=1.5V$, and $O_{Load}=15\text{ pF}$.
	Aging Tolerance 1 Year	-1		+1	$\times 10^{-6}$	$T_A=25^\circ\text{C}, V_{cc}=3.3V, V_c=1.5V$ and after 1h of operation.
	24Hr Holdover Stability(option)	-0.04		+0.04	$\times 10^{-6}$	24hours at constant temperature after 48H operation
	Free Run Stability for 20Years(option)	-4.6		+4.6	$\times 10^{-6}$	Inclusive of initial tolerance at 25°C, temperature, supply voltage $\pm 5\%$, load $\pm 5\%$, reflow soldering and ageing 20years.
Power Supply	Operating Current			10	mA	@25°C, $V_{cc}=3.3V, V_c=1.5V, O_{Load}=15\text{ pF}$.
	Supply Voltage	3.13	3.3	3.47	V	



Voltage Control Characteristics	Frequency Tuning Range	-16		-5	$\times 10^{-6}$	$V_c=0.5$ V. measurement referenced to $V_c=1.5$ V.
		-2		+2	$\times 10^{-6}$	$V_c=1.5$ V. measurement referenced to Exactly 10.00MHz.
		+5		+16	$\times 10^{-6}$	$V_c=2.5$ V. measurement referenced to $V_c=1.5$ V.
	Linearity			10	%	
	Slope	Positive				
	Input Impedance	100			K Ω	
Phase Noise	Phase Noise@25°C		-140		dBc/Hz	1KHz
Environmental Conditions	Operable Temperature	-40		+85	°C	
	Storage Temperature	-55		+125	°C	
	ESD Level	Human Body Model,class2: 2000V to 4000V; ANSI/ESDA/JEDEC JS-001-2010.				
		Machine Model, class B: 200V to 400V; JEDEC JESD22-A115C.				
	Moisture Sensitivity Level	Level 3.				
	Vibration	Test Condition: 0.75mm ;acceleration:10g;10Hz~2000Hz, one cycle per 30 min, test 2 hour. (3 times for each 3 directions X ,Y , Z) .IEC 68-2-06 Test Fc.				
Shock	100g; 6ms; half sine wave (3 times for each 3 directions X ,Y, Z),IEC 68-2-27 Test Ea/Severity 50A.					
Full Package Storage	Relative humidity (%)	20%~70%				
	Temperature (°C)	-10~35°C				



2. Mechanical Structure(mm)

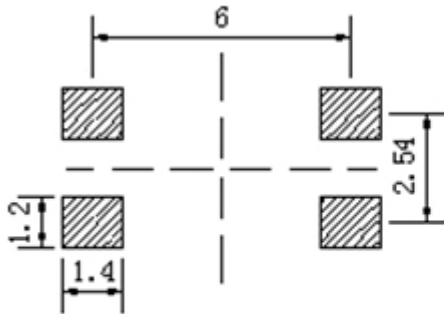

Solder pad layout

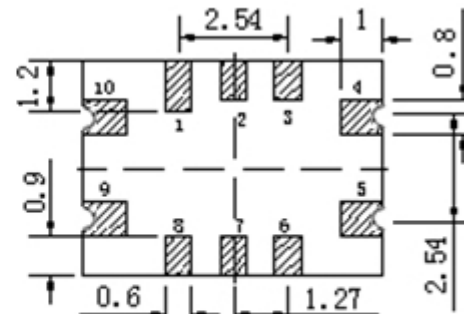

Bottom view

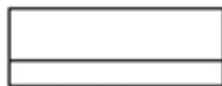

Right view

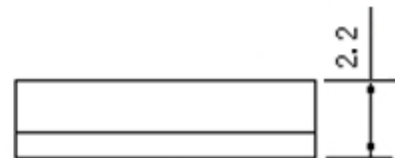

Front view

PIN FUNCTION

PIN	NOTATION	FUNCTION
1, 2, 3, 6, 7	NC	Not Connect
4	GND	GND
5	OUTPUT	RF Output
8	Tri-state	Enable/Disable
9	VCC	Supply Voltage
10	VC	Control Voltage

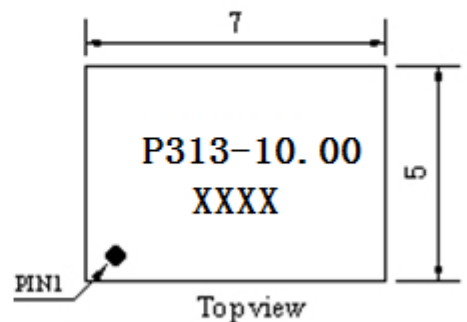

Topview

Note1: Tolerance $\pm 0.2\text{mm}$ without mark

Note2: The first two xx representative: week

After two xx representative: year

Note3: Referential Weight 0.2g

Note4: The Tri-state Enable is "1" or "open", Disable is "0"



3. Test Circuit

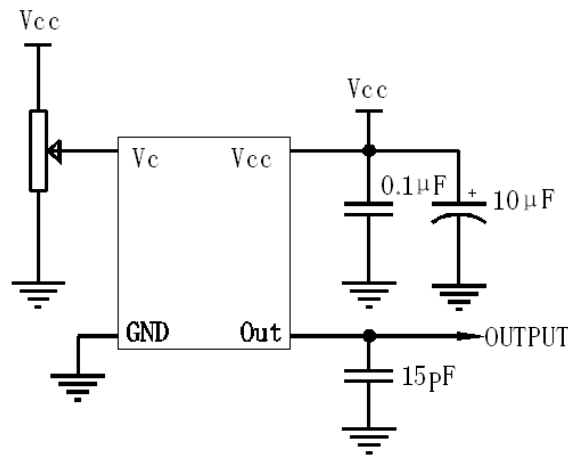

4. Output Waveform

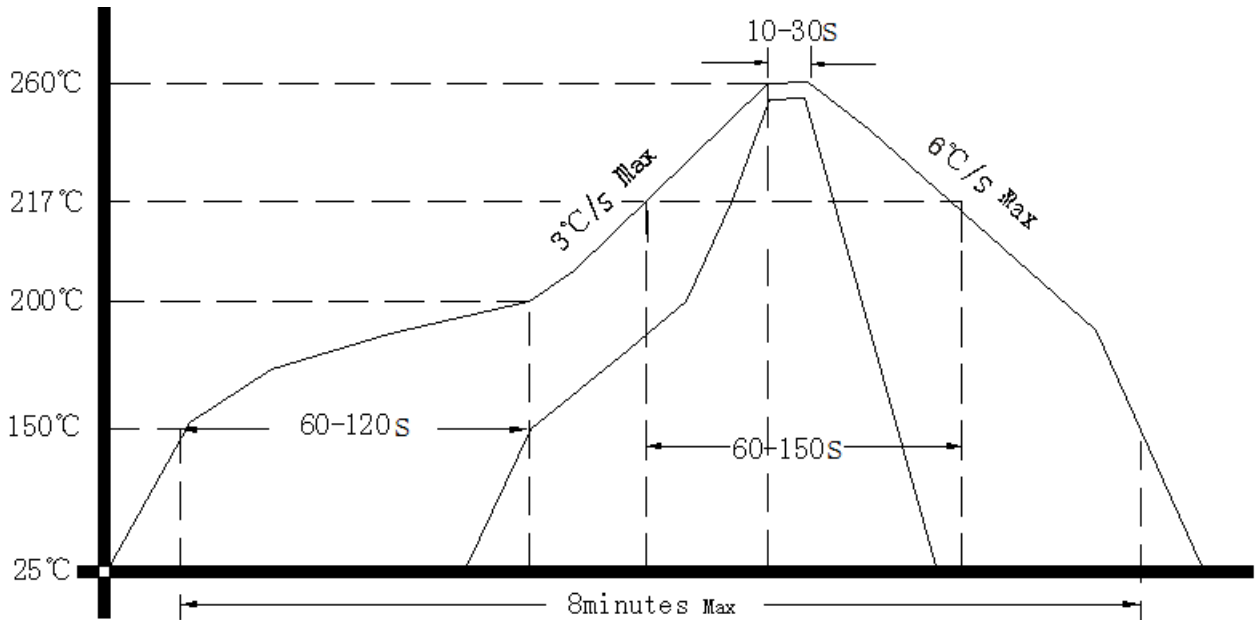

5. Package: Tape & Reel (mm)

