

5mm SMD ISOLATOR

RF component

Datasheet No.: _____
Date: 2022.06.30

Customer:

Product Name:

DP-IL0520A2350-J3

DP-IL0520B2350-J3

Customer P/N:



GuangdongDapuTelecomTechnologyCo.,Ltd Building5, No.24, Gongye East Road,
<http://www.dptel.com> SSL Sci & Tech Industry Park,
Dongguan, Guangdong, China
TEL: 0086-0769-88010888
FAX: 0086-0769-81800098

Approved	Checked	Designer
Nick	Wison	ZC.Wu

5mm SMD ISOLATOR

RF component

Datasheet No.: 0
 Date: 2022.06.30

MECHANICAL SPECIFICATION

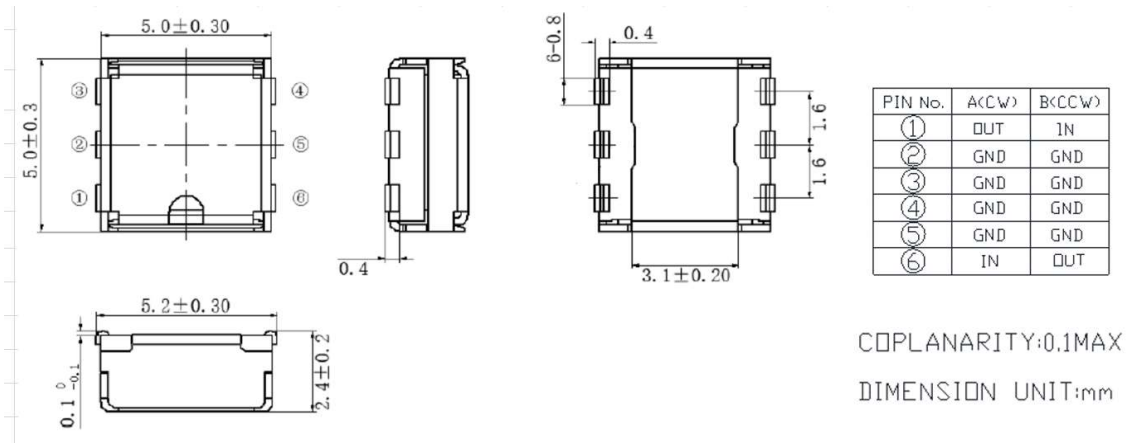

MARKING

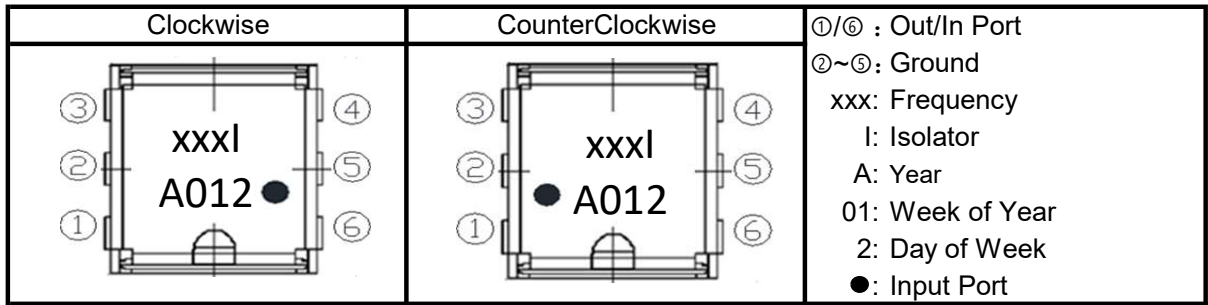

Year Code	
Year	Code
2019	A
2020	B
2021	C
2022	D
2023	E
2024	F
...	...

Week Code	
Week	Code
1	01
2	02
3	03
4	04
5	05
6	06
...	...

Day Code	
Day	Code
Monday	1
Tuesday	2
Wednesday	3
Thursday	4
Friday	5
Saturday	6
Sunday	7

5mm SMD ISOLATOR

RF component

Datasheet No.: 0
 Date: 2022.06.30

TEMPERATURE RANGE

Operating temperature range : -40~+85°C

Storage temperature range:-40~+125°C

ELECTRICAL CHARACTERISTICS

Parameter	Unit	Frequency (MHz)		DP Spec		
				Min.	Typ.	Max.
Frequency range	MHz	2300	2400	2300		2400
Insertion Loss	dB	-	-			0.80
Isolation	dB	-	-	14		
Return Loss	dB	-	-	14		
IMD3 (2*25dBm, Span 5MHz)	dBc					-60
IMD3 typical	dBc				-68	
Power Handling (Average)	W					5
Power Handling (Peak)	W					10
Reflection power	W					2
Characteristic Impedance (ohm)	Ω				50	
Case Style	-				SMD	

NOTES

1. Recommend to keep 30mm above when mounted with other magnetic products.
2. RoHS compliance.
3. Isolator's characteristics are guaranteed at conditions listed at above table and it's operating temperature range.

5mm SMD ISOLATOR

RF component

Datasheet No.: 0
 Date: 2022.06.30

RECOMMENDED LAND PATTERN

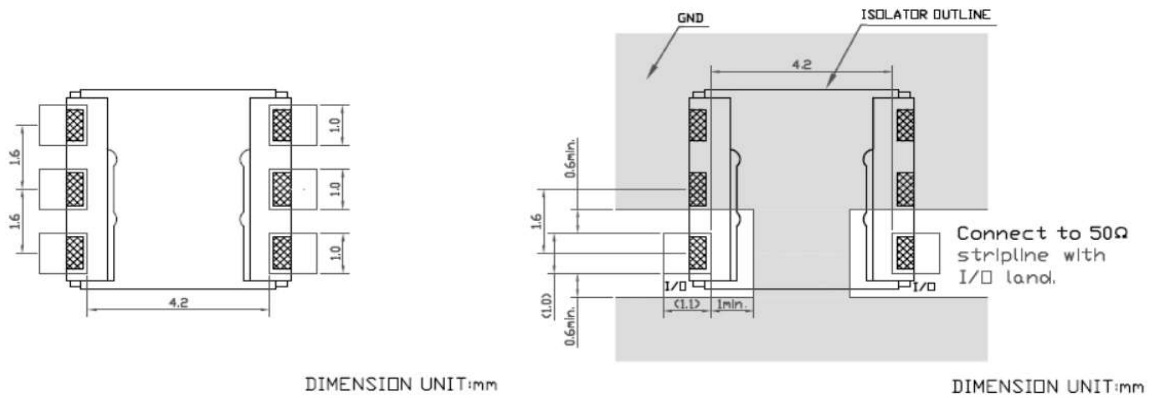

RECOMMENDED REFLOW PROFILE

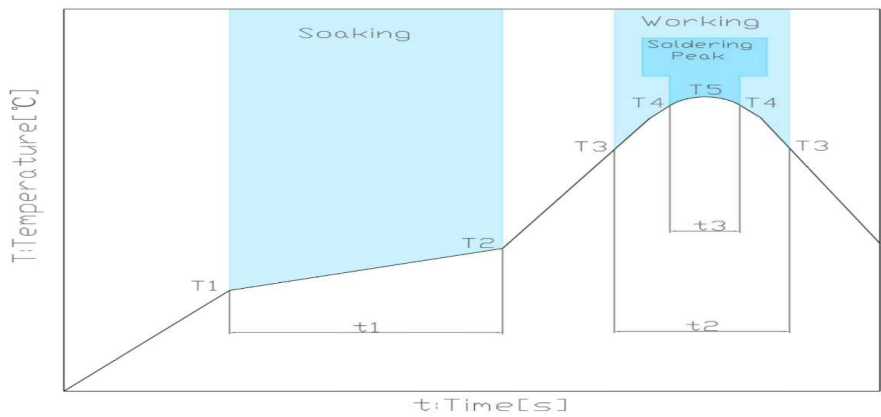

Soaking			Working		Soldering Peak		
Temp.	Time		Temp.	Time	Temp.	Time	Temp.
T1	T2	t1	T3	t2	T4	t3	T5
150°C	180°C	60 to 120s	230°C	30 to 60s	250°C	within 10s	260°C max.

5mm SMD ISOLATOR

RF component

Datasheet No.: 0
 Date: 2022.06.30

PACKING STYLE

REEL DIMENSIONS

Reel side \longrightarrow Pulling side

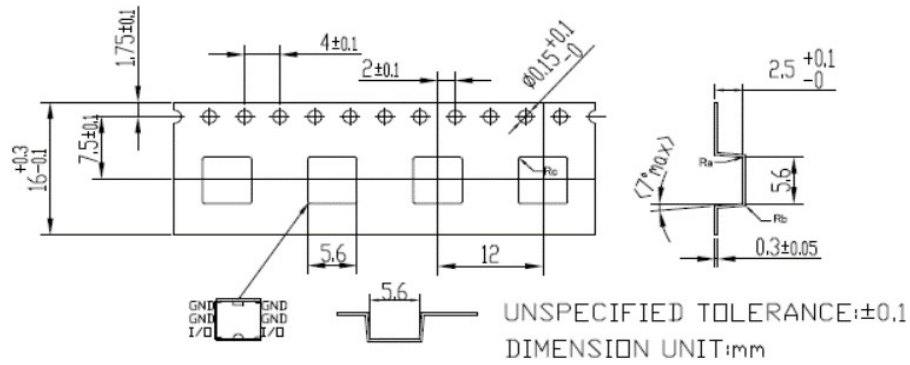

TAPE DIMENSIONS

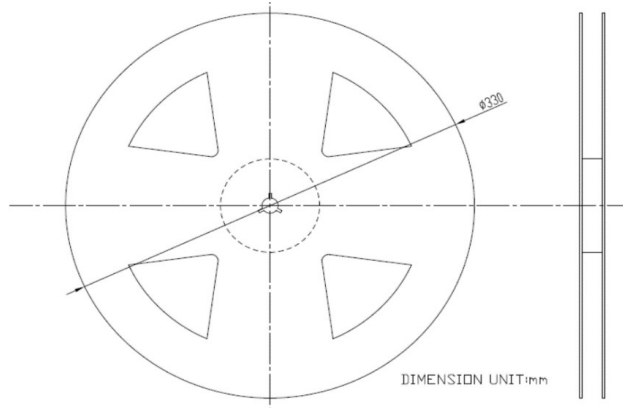

PACKAGE QUANTITY

1000 PCS/REEL

5mm SMD ISOLATOR

RF component

Datasheet No.: 0
Date: 2022.06.30

Revision Records

Rev.	Date	PIC	Change item	Reasons for change
1	2021.06.27	Nina	New regulations	
2	2022.06.30	ZC.Wu	Dimension and marking	
3				
4				
5				
6				
7				
8				