

Customer Code: _____

DATASHEET

DAPU P/N: DPZ2150M0000722A0

DAPU			Customer Approval
Drew	Audited	Approved	Stamp, please! Thanks!
Jack	David	William	
Date: 2022.05.21			

Guangdong Dapu Telecom Technology Co.,Ltd

Building 5, No.24, Industrial East Road, Songshanhu Park, Dongguan, Guangdong, P.R. China

TEL: 0086-0769-88010888 FAX: 0086-0769-81800098



1、 Electrical Parameters

MODEL: DPZ2150M0000722A0							
No.	Parameters	SYM.	Electrical Spec.				Notes
			Min.	Typ.	Max.	Units	
1	Nominal Frequency	FL	50.00			MHz	
2	Oscillation Mode	-	Fundamental				
3	Frequency Tolerance	-	-20		+ 20	$\times 10^{-6}$	At 25°C
4	Frequency Stability	-	-30		+ 30	$\times 10^{-6}$	Over Operating Temperature Range
5	Operating Temperature	Topr	-40	~	+ 85	°C	
6	Storage Temperature	Tstg	-55	~	+ 125	°C	
7	Supply Voltage	V _{DD}	2.97	3.3	3.63	V	
8	Input Current	I _{cc}			10	mA	
9	Output waveform	-	CMOS				
10	Output Load	CL	15			pF	
11	Output Voltage High	V _{OH}	90%			V _{DD}	
12	Output Voltage Low	V _{OL}			10%	V _{DD}	
13	Rise/Fall Time	Tr、 Tf			5	ns	10%-90% V _{DD} Level
14	Aging	-	-3		+ 3	$\times 10^{-6}$	First Year at 25°C
15	Tri-State Output Enable	-	70%			V _{DD}	Pin 1, OE
16	Tri-State Output Disable	-			30%	V _{DD}	Pin 1, OE
17	Duty Cycle	-	45	~	55	%	
18	Start-Up Time	Tstart			5	ms	Measured from the time V _{DD} reaches its rated minimum value



2、Mechanical Structure(mm)

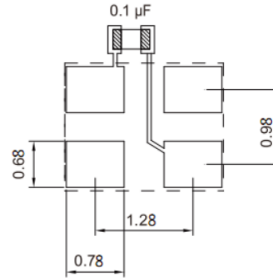
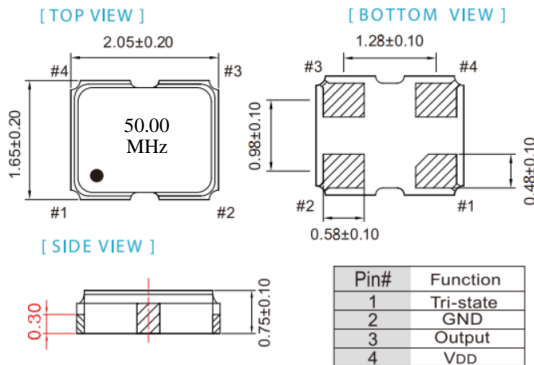

To ensure optimal oscillator performance, place a by-pass capacitor of 0.1µF as close to the part as possible between Vdd and GND pads.

3、Test Circuit

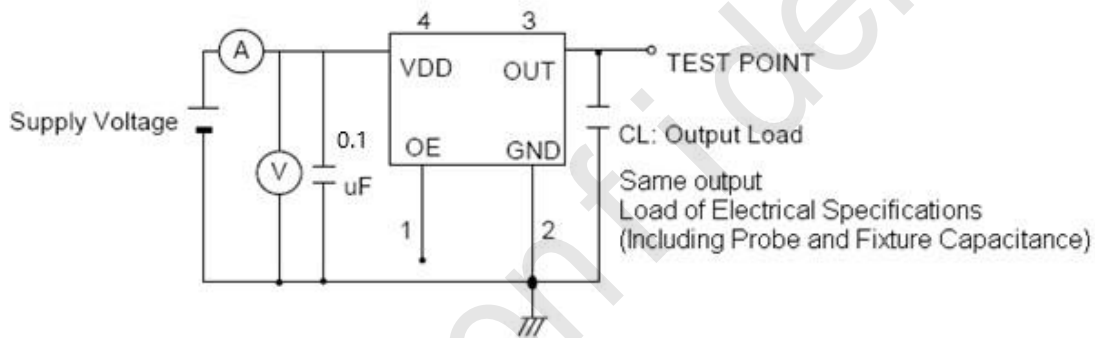

Control input (output enable/disable)

Logic 1 or open on pad 1: Oscillator output

Logic 0 on pad 1 : Disable output to high impedance



4、 Reflow Soldering Curve (RoHS)



5、 Package: Tape & Reel (mm)

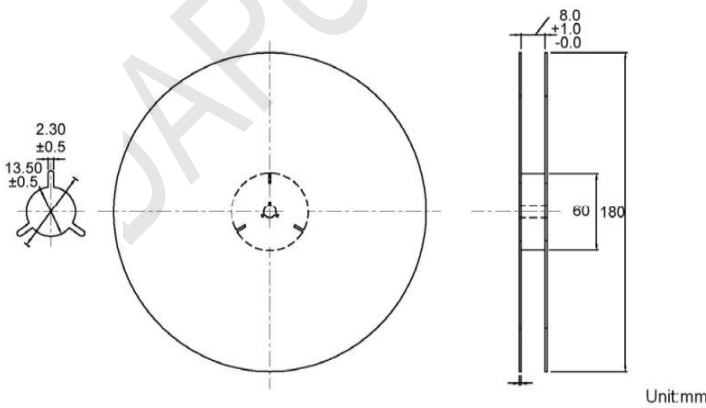
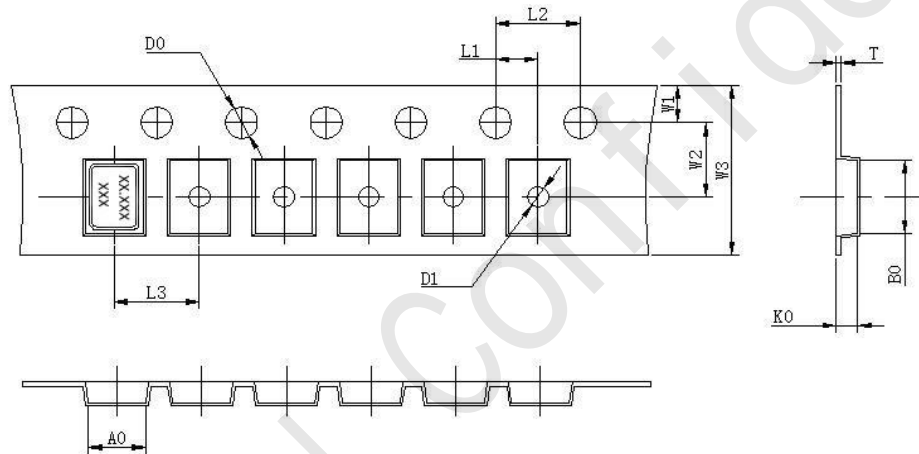

L1	2.00±0.1
L2	4.00±0.1
L3	4.00±0.1
D0	1.50±0.1
D1	0.6±0.1
W0	8.50±0.2
W1	1.75±0.1
W2	3.50±0.1
W3	8.00±0.1
A0	1.85±0.1
B0	2.25±0.1
K0	0.65±0.1
T	0.25±0.05

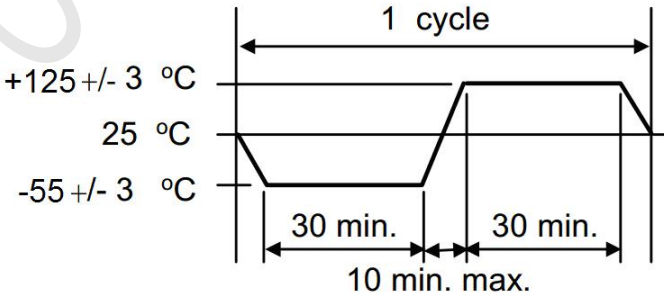

6、 Reliability Test Specification

NO.	Test Items	Test Standard	Test Condition	Specifications
1	Drop test	GB/T2423.8	Drop from 150cm height on 3cm hard wooden board for 3 times	Electrical performance meets specification requirements
2	Mechanical shock	GB/T2423.5	Peak: 100g; Waveform: Half-sine; Velocity Change: 1000m/s ² ; Duration: 0.5ms; 3 times/direction, Direction: +X, -X, +Y, -Y, +Z, -Z.	
3	Vibration	GB/T2423.10	Frequency: 10~2000Hz; Vibration:20min, 1.52mm; Direction: X, Y, Z; Duration: 2 hours/direction.	
4	Solderability	IEC60068-2-58	Solder bath temperature:245±5°C Dwell time:3±0.5 seconds, Solder: 100% tin	
5	Resistance to soldering heat	IEC60068-2-58	Solder temperature 260±5°C, Immersion time:10±1 S Solder bath composition:100% tin	
6	High temperature storage	GB/T2423.2	Temperature: 125°C±2°C; Duration: 500±12hours;	
7	Low temperature storage	GB/T2423.1	Temperature: -40°C±2°C; Duration: 500±12hours;	
8	Temperature Shock	GB/T2423.22	Do 10 cycles at the following temperature 	
9	High temperature high humidity storage	GB/T2423.3	Temperature: 85°C±3°C; Humidity: 85%; Duration: 500hours;	