



DP3763C

ENG PART: DP-10.2CM-4900T6100-CW

4900MHz to 6100MHz Single-Junction Surface Mount Circulator

REV.	DESCRIPTION	REVISOR	DATE	APPROVED
A	SAME AS REV.1	ZZ.Zhu	2025/3/3	Nick

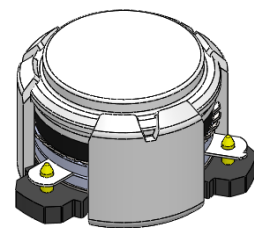

Applications:

- Wireless Infrastructure
- Power Amplifier

Features:

- Operating frequency range: 4900MHz to 6100MHz
- Operating temperature range: -40°C to +85°C
- Storage temperature range: -50°C to +135°C
- Small surface-mount package delivered on T&R
- BeO free & RoHS compliant

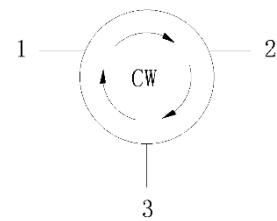

Block Diagram



Electrical Specifications:

ITEM	SPECIFICATION	
Frequency	4900~6100	MHz
Direction	CW	
Impedance	Typ: 50	Ω
Insertion Loss (Max.)	0.5@25±5°C 0.6@-40~+85°C	dB
Isolation (Min.)	18@25±5°C 16@-40~+85°C	dB
Return Loss(Min.)	18@25±5°C 16@-40~+85°C	dB
3rd IMD (Max.)	/	dBc
2nd harmonic	/	dB
3rd harmonic	/	dB
Power FWD/REV/PEAK	30/30/250	W
Input Impedance ,real	/	Ω
Input Impedance ,imaginary	/	j Ω
Termination/Attenuator	/	W/dB

Notes:

1. Exposure to maximum rating conditions for extended periods may reduce device reliability. There is no damage to device with only one parameter set at the limit and all other parameters set at or below their nominal value. Exceeding any of the limits listed here may result in permanent damage to the device.
2. Performance is guaranteed under the conditions listed in this table and over the operating temperature range.



Mechanical Specifications:

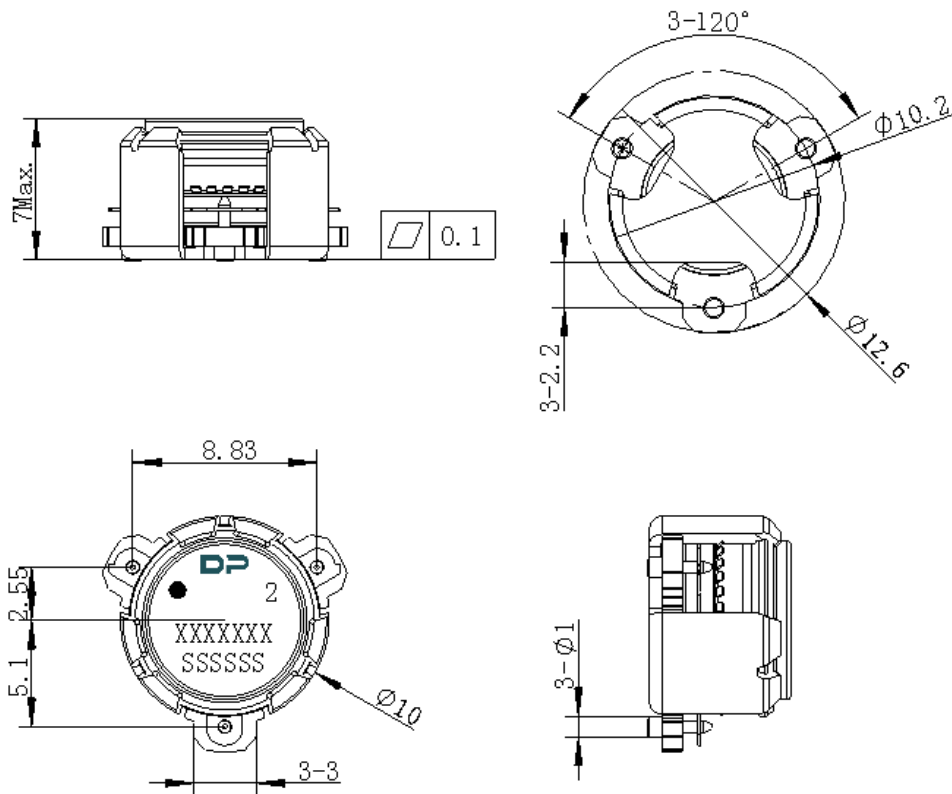

Unit: Millimeters

Notes:

1. The housing and pins are silver-plated.
2. Tolerance ± 0.2 mm unless otherwise specified.
3. Co-planarity Specification: 0.1mm maximum.
4. Part Number, Lot Code, and Port Designation are printed on the top side of device
5. The **XXXXXXX** on the label represents the part number
6. The **SSSSSS** on the label represents the serial number
7. The black dot on the label represents the input port



Packaging Style:

ITEM	W	A0	B0	C0	K0	D	E	F	F2	P	P0	P2	T
DIM	32	Φ10.4	12.5	4	7.0	Φ1.5	1.75	14.2	28.5	24	4	2	0.5
TOLE	±0.3	±0.2	±0.2	±0.2	±0.2	+0.1	±0.1	±0.15	±0.1	±0.1	±0.1	±0.1	±0.05

