



1. Electrical Parameters

MODEL: T75A-1801-38.88MHz						
Item	Description	Parameters			Unit	Test Condition
		Min.	Typ.	Max.		
Output	Frequency	38.88			MHz	
	Output Waveform	HCMOS				
	Output Low Voltage			0.33	V	$V_{cc}=3.3V, O_{load}=15\text{ pF}$
	Output High Voltage	2.97			V	$V_{cc}=3.3V, O_{load}=15\text{ pF}$
	Duty Cycle	45	50	55	%	@50%
	Rise / Fall Time (10%~90%)			5	ns	@25°C
	Spurious suppression			5	dBc	
	Start up time			10	ms	
	Load	15			pF	
Frequency Stabilities	Overall Tolerance	-7		+7	$\times 10^{-6}$	Including 10 years of 85°C aging.
	Frequency Tolerance vs. Operating Temperature Range	-0.5		+0.5	$\times 10^{-6}$	T_A varied from -40°C to 105°C, measurement referenced to frequency observed with $f_{ref}=(f_{max}+f_{min})/2, V_{cc}=3.3V, O_{load}=15\text{ pF}$, temperature variable speed less than 2°C per minute.
	Initial Frequency Tolerance	-1.5		+1.5	$\times 10^{-6}$	Measurement referenced to frequency observed with $T_A=25^\circ\text{C}, V_{cc}=3.3V$ within 30 days after ex-works.
	Frequency Tolerance vs. Supply Voltage	-0.1		+0.1	$\times 10^{-6}$	measurement referenced to frequency observed $T_A=25^\circ\text{C}, V_{cc}$ varied from 3.13V to 3.47V, and $O_{Load}=15\text{ pF}$.
	Frequency Tolerance vs. Load	-0.1		+0.1	$\times 10^{-6}$	5% load change measurement referenced to frequency observed with $T_A=25^\circ\text{C}, V_{cc}=3.3V, O_{Load}=15\text{ pF}$.
	Short-Term Stability			0.1	$\times 10^{-9}$	No temperature changed.
	Frequency Slope	-0.05		+0.05	$\times 10^{-6}$	Temperature ramp 2°C/minute, Test interval: test per 1°C



Power Supply	Current Consumption			10	mA	@25°C, V _{cc} =3.3V, O _{Load} =15pF.
	Supply Voltage	3.13	3.3	3.47	V	
Phase Noise	Phase Noise			-53	dBc/Hz	1Hz
				-88		10Hz
				-112		100Hz
				-135		1KHz
				-142		10KHz
				-145		40KHz
				-150		100KHz
				-150		1MHz
Jitter	Jitter			1	ps-rms	10Hz-100KHz
Environmental Conditions	Operable Temperature	-40		+105	°C	
	Storage Temperature	-55		+125	°C	
	ESD Level	Human Body Model,class2: 2000V to 4000V; ANSI/ESDA/JEDEC JS-001-2010.				
		Machine Model, class B: 200V to 400V; JEDEC JESD22-A115C.				
	Moisture Sensitivity Level	Level 3.				
	Vibration	Test Condition: 0.75mm ;acceleration:10g;10Hz~2000Hz, one cycle per 30 min, test 2 hour. (3 times for each 3 directions X , Y , Z).IEC 68-2-06 Test Fc.				
Shock	100g; 6ms; half sine wave (3 times for each 3 directions X , Y , Z),IEC 68-2-27 Test Ea/Severity 50A.					



2. Mechanical Structure(mm)

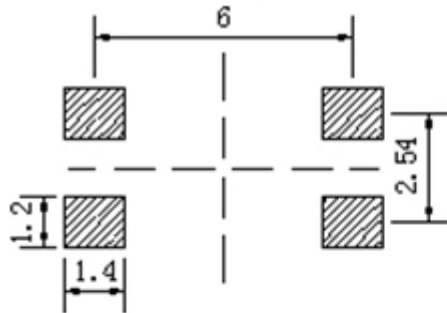

Solder pad layout

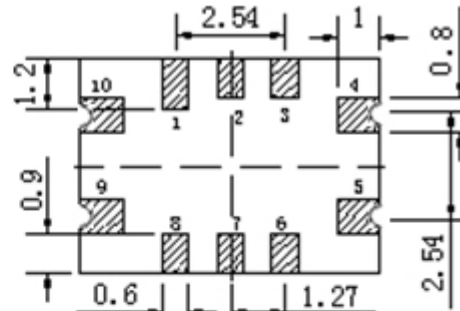

Bottom view

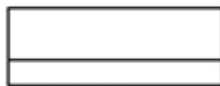

Right view

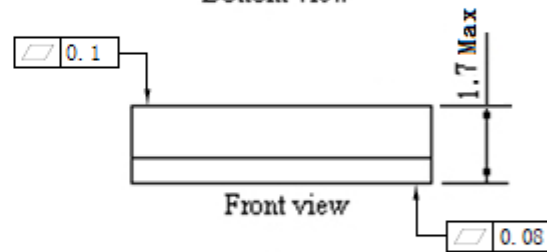

Front view

PIN FUNCTION

PIN	NOTATION	FUNCTION
1, 2, 3, 6, 7	NC	Not Connect
4	GND	GND
5	OUTPUT	RF Output
8	NC	Not Connect
9	VCC	Supply Voltage
10	NC	Not Connect

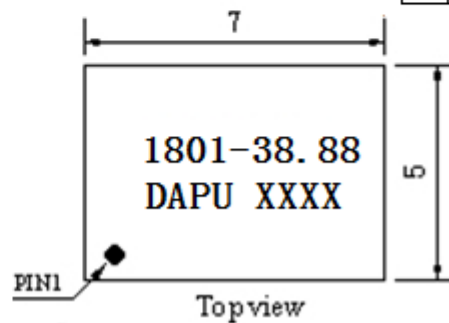

Topview

Note1: Tolerance $\pm 0.25\text{mm}$ without mark

Note2: The first two xx representative: year

After two xx representative: week

Note3: Referential Weight 0.2g

Note4: NC is not connect



3. Test circuit

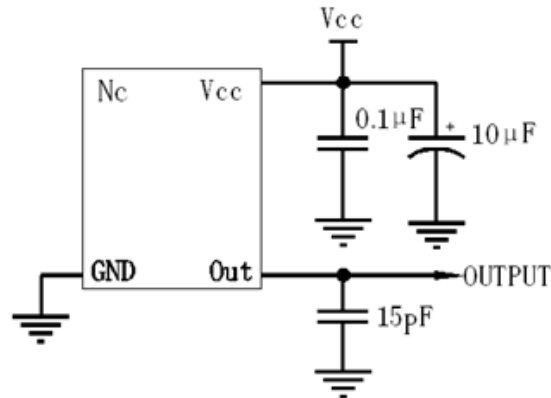

4. Reflow Soldering Curve (RoHS)

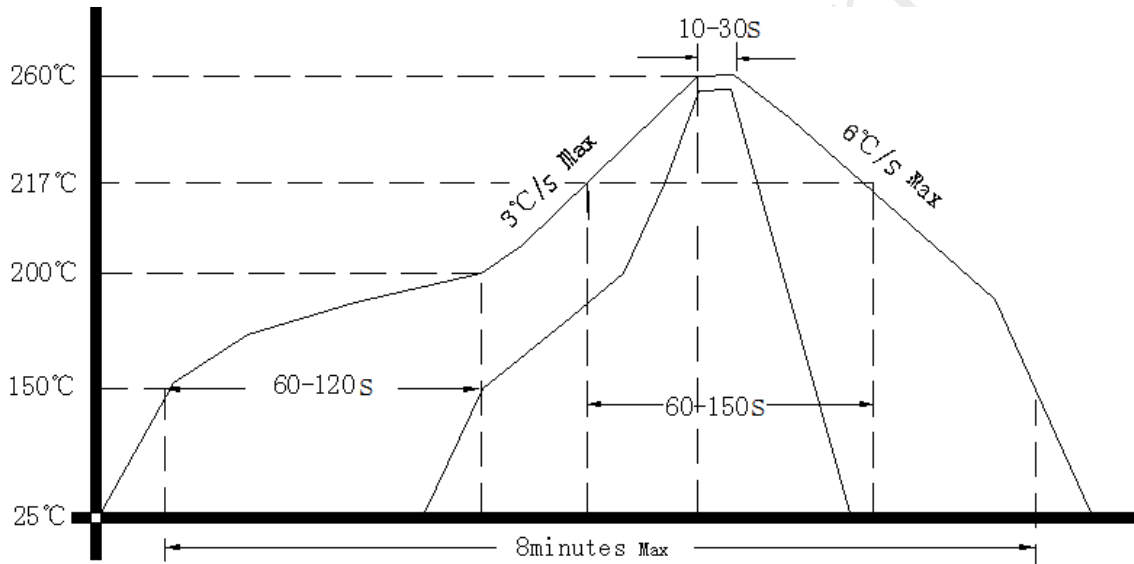

5. Package: Tape & Reel (mm)

