

Customer Code: _____

DATASHEET

DAPU P/N: DPX3248M000008A001

DAPU			Customer Approval
Drew	Audited	Approved	
Jieshu ZHENG	Jianhua LIN	Gangtao FENG	
Date: 2024/10/28			

Stamp, please! Thanks!

Guangdong Dapu Telecom Technology Co.,Ltd

Bldg 5, SSL Modern Enterprise Accelerator Zone, Dongguan City, Guangdong Province, PRC China
TEL: 0086-0769-88010888 FAX: 0086-0769-81800098

1、Electrical Parameter

MODEL:		DPX3248M000008A001					
No.	Parameters	SYM.	Electrical Spec.				Notes
			Min.	Typ.	Max.	Units	
1	Specification	-	3225			-	
2	Nominal Frequency	FL	48.000			MHz	
3	Oscillation Mode	-	Fundamental			-	
4	Load Capacitance	CL	8			pF	
5	Frequency Tolerance	-	-10		10	$\times 10^{-6}$	At 25°C
6	Frequency Stability	-	-20		20	$\times 10^{-6}$	Over Operating Temperature Range (Reference 25 °C)
7	Operating Temperature	Topr	-40		85	°C	
8	Storage Temperature	Tstg	-55		125	°C	
9	Drive Level	DL	-	100	-	μ W	
10	Equivalent Series Resistance	ESR			40	Ω	
11	Shunt Capacitance	C0			3	pF	
12	Insulation Resistance	IR	500			M Ω	At DC 100V
13	Aging	-	-3		3	$\times 10^{-6}$	First year at 25°C
14	Standard	-	-			-	

2、 Mechanical Structure

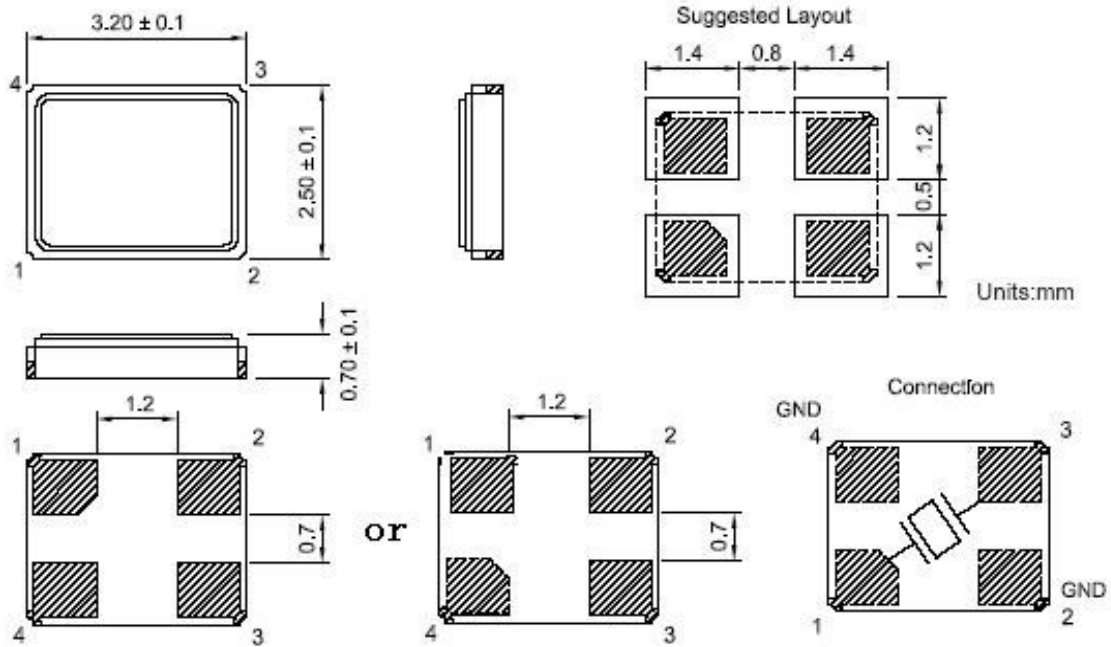

3、 Marking

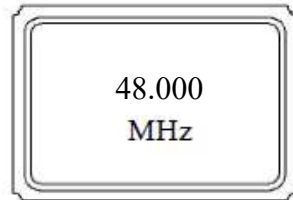

48.000 ----- Nominal frequency

4、 Reflow Soldering Curve (RoHS)

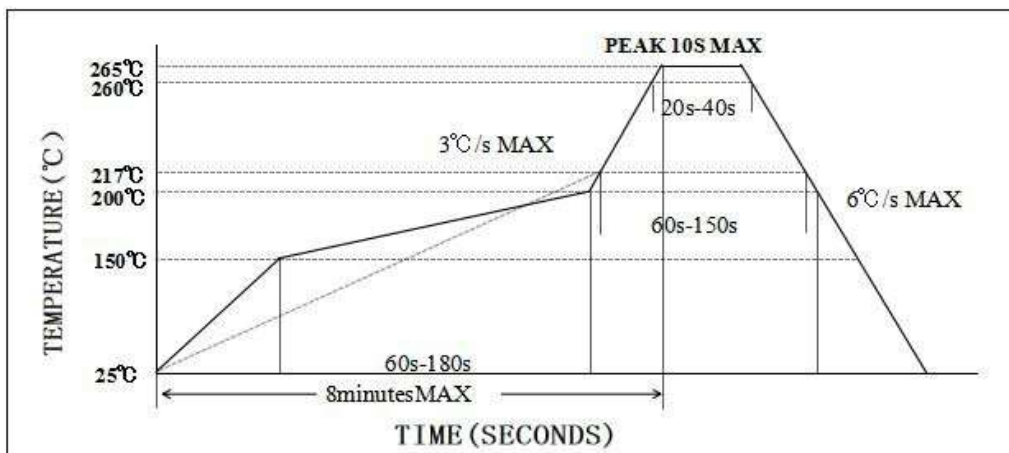

5、 Package: Tape & Reel (mm)

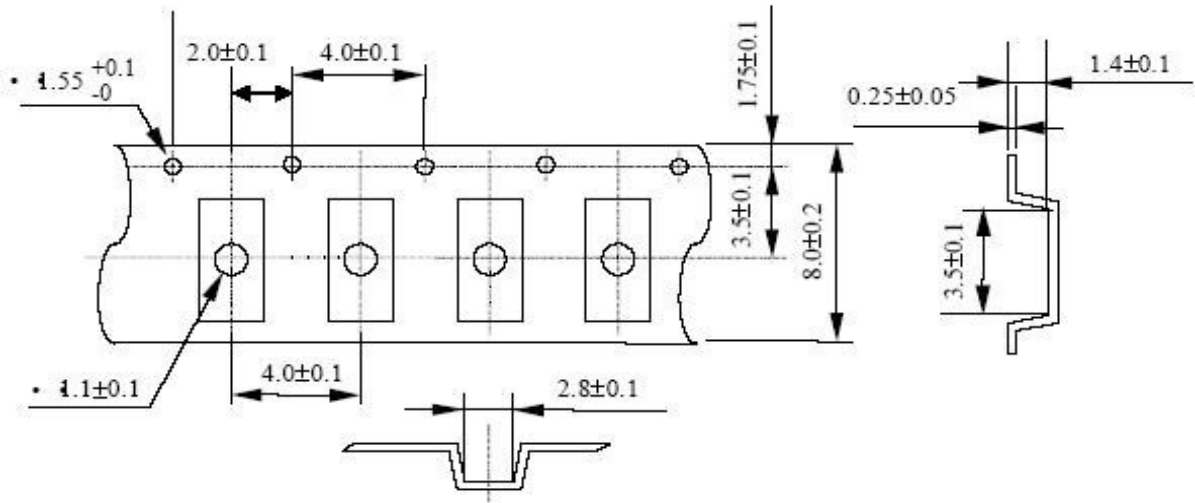

[Size in mm]

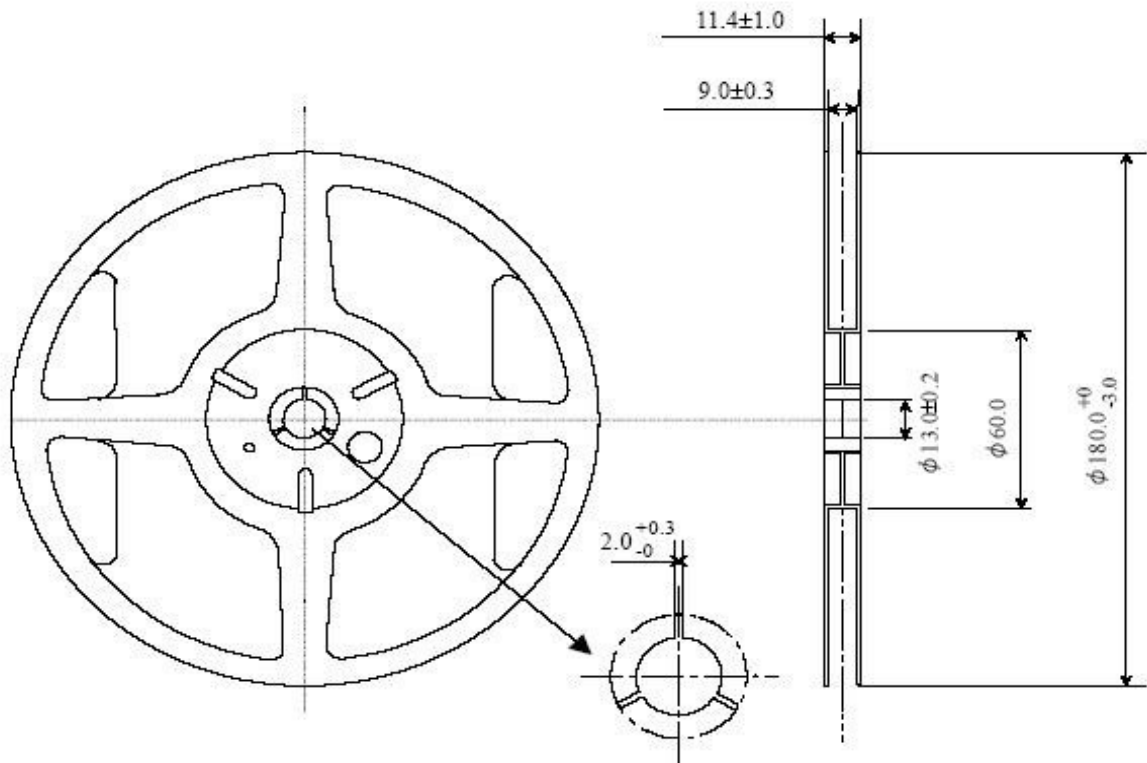

6、RELIABILITY SPECIFICATIONS

NO.	Test Items	Test Condition	Reference
1	High Temperature High Humidity Storage	Temperature: 85°C±3°C Relative Humidity:85%RH Time: 96 Hours	JIS C5023
2	High Temperature Storage	Temperature: 125°C±2°C Time: 96 Hours	MIL-STD-883E Method 1005.8
3	Low Temperature Storage	Temperature: -40°C±2°C Time: 96Hours	MIL-STD-883E Method 1013
4	Thermal Shock	Temperature1:-55°C±5°C Temperature2:85°C±5 °C Temperature change between T1 and T2 5 min 10cycles maintain T1 and T2 for 30 minutes each mone cycle	MIL-STD-202F Method 107 Condition A
5	Resistance To Solder Heat	Solder Temperature: 260°C±5°C Time: 10±1 Seconds	MIL-STD-202F Method 210E
6	Solderability	The solder pot temperature is 245±5°C ,dwell time 5±0.5sec	J-STD-002B
7	Drop Test	3 Times Free Fall from 75cm height table to 3cm thickness hard wood board	JIS C6701
8	Mechanical Shock	Half sine wave,1000 G 3 Times for all 3 directions	MIL-STD-202F Method 213B
9	Vibration	Frequency Range: 10Hz~55Hz Amplitude: 0.75mm 2 Hours in each direction, total 6 Hours	MIL-STD-883E Method 2007.3
10	Leakage Test	Take measurements with a helium Leakage detector Rate≤1×10 ⁻³ Pa cm ³ /s	MIL-STD-883E