





### Table of amendment

Version	Revision contents	Prepared by	Revised date
1.0	The first issued	<i>Amway</i>	2016.05.27
1.1	“Mechanical Structure” and “Test Circuit” changed	<i>Amway</i>	2016.09.29
1.2	The “Mechanical Structure” changed	<i>Amway</i>	2018.08.20
1.3	The “Moisture Sensitivity Level” changed	<i>Amway</i>	2019.05.21



## 1. Electrical Parameters

MODEL: O11F-1804-38.88MHz						
Item	Description	Parameters			Unit	Test Condition
		Min.	Typ.	Max.		
Output	Frequency	38.88			MHz	
	Output Waveform	HCMOS				
	Output Low Voltage			0.4	V	$V_{cc}=3.3V, O_{load}=15pF$
	Output High Voltage	2.4			V	$V_{cc}=3.3V, O_{load}=15pF$
	Duty Cycle	45		55	%	@50%
	Rise / Fall Time (10%~90%)			6	ns	
	Load	13.5		16.5	pF	
Frequency Stabilities	Frequency Tolerance vs. Operating Temperature Range	-0.1		+0.1	$\times 10^{-6}$	$T_A$ varied from $-40^{\circ}C$ to $85^{\circ}C$ , measurement referenced to frequency observed with $T_A=25^{\circ}C, V_{cc}=3.3V, O_{load}=15pF$ , temperature rise speed less than $2^{\circ}C$ per minute.
	Slope( $-40^{\circ}C$ ~ $+85^{\circ}C$ )	-3		+3	ppb/ $^{\circ}C$	Temperature ramp $1^{\circ}C$ /minute
	Initial Frequency Tolerance	-0.5		+0.5	$\times 10^{-6}$	After warm up 15 minute Measurement referenced to frequency observed with $T_A=25^{\circ}C, V_{cc}=3.3V$ , and after 1 hours of operation
	Frequency Accuracy	-0.5		+0.5	$\times 10^{-6}$	Within 90 days after shipment 15 minute warm up time, Measurement referenced to exactly 38.88MHz
	Frequency Tolerance vs. Supply Voltage	-50		+50	$\times 10^{-9}$	measurement referenced to frequency observed $T_A=25^{\circ}C, V_{cc}$ varied from 3.135 V to 3.465V, and $O_{Load}=15pF$ .
	Frequency Tolerance vs. Load	-50		+50	$\times 10^{-9}$	10% load change measurement referenced to frequency observed with $T_A=25^{\circ}C, V_{cc}=3.3V$ , and $O_{Load}=15pF$ .
	Short-Term Stability: Allan Variance			0.1	$\times 10^{-9}$	Temperature stability, no EMI\EMC or other interference, test after power for 1hour ref. to $25^{\circ}C$ ; 1s, using PN9000 equipment.
	Aging Tolerance Per Day	-5		+5	$\times 10^{-9}$	$V_{cc}, T_A$ constant measurement referenced to frequency observed with $T_A=25^{\circ}C, V_{cc}=3.3V$ , and after 30 days of operation.
	Aging Tolerance 1 Year	-0.5		+0.5	$\times 10^{-6}$	
	Aging Tolerance 10 Year	-4.6		4.6	$\times 10^{-6}$	



Power Supply	Supply Voltage	3.135	3.3	3.465	V	
	Steady Consumption			300	mA	@25°C
	Warm up current			700	mA	
	Warm-Up Time			5	minutes	@25°C within $\pm 0.1 \times 10^{-6}$ of final frequency with reference after 1 hours on.
Phase Noise	Phase Noise			-65	dBc/Hz	1Hz
				-95		10Hz
				-120		100Hz
				-135		1KHz
				-145		10KHz
				-152		100KHz
				-152		1MHz
				-152		5MHz
Jitter			450	fs	RMS(10Hz-5MHz)	
Environmental Conditions	Operable Temperature	-40		+85	°C	
	Storage Temperature	-55		+125	°C	
	ESD Level	Human Body Model, class2: 2000V to 4000V; ANSI/ESDA/JEDEC JS-001-2010.				
		Machine Model, class B: 200V to 400V; ANSI/ESDA/JEDEC JS-001-2010.				
	Moisture Sensitivity Level	Level 2.				
	Vibration	Test Condition: 0.75mm ;acceleration:10g;10Hz~500Hz, one cycle per 30 min, test 2 hour. (3 times for each 3 directions X , Y , Z), IEC 68-2-06 Test Fc.				
Shock	50g; 11ms; half sine wave (3 times for each 3 directions X, Y, Z), IEC 68-2-27 Test Ea/Severity 50A.					
Full Package Storage	Relative humidity (%)	20%~70%				
	Temperature (°C)	-10~35°C				



## 2. Mechanical Structure (mm)

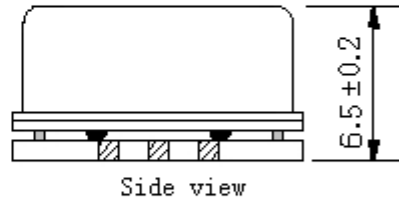
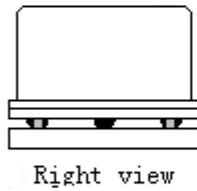
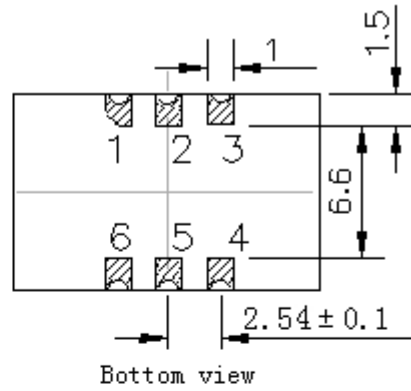
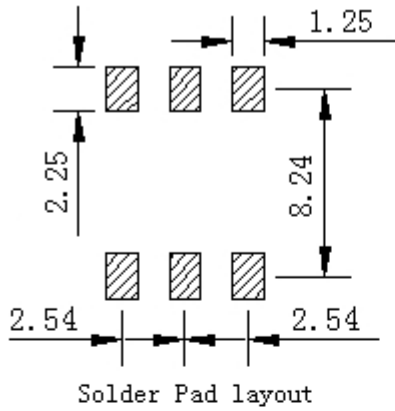

### PIN FUNCTION

PIN	NOTATION	FUNCTION
1	NC	Not Connect
2,5	NC	Not Connect
3	GND	GND
4	OUTPUT	RF Output
6	VCC	Supply Voltage

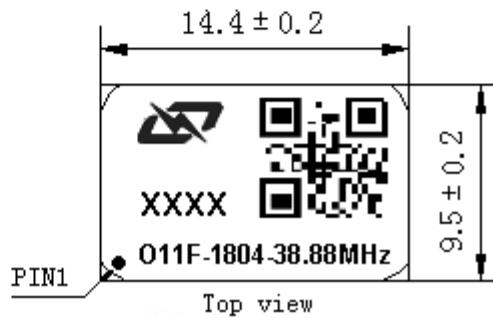

- Note1:** Tolerance  $\pm 0.2$ mm without mark
- Note2:** Referential weight 2.2g
- Note3:** NC is not connect
- Note4:** The first two xx representative: week  
After two xx representative: year



### 3. Test Circuit

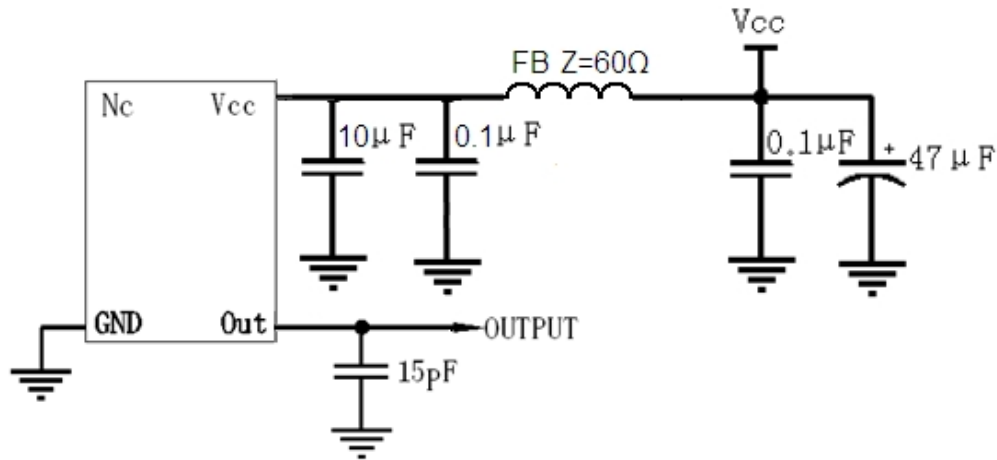

### 4. Reflow Soldering Curve (RoHS)

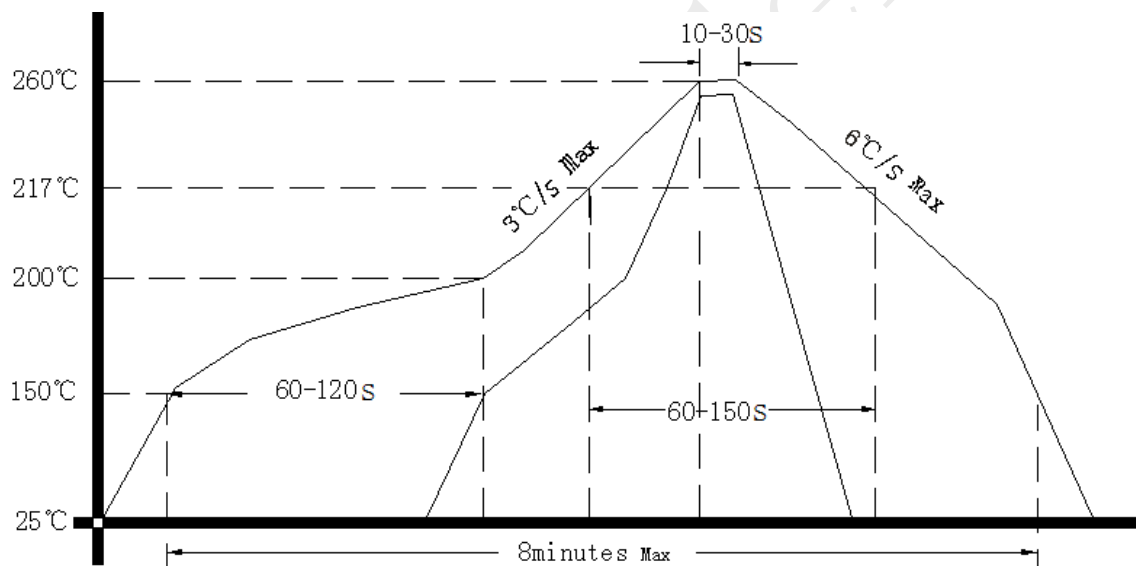

### 5. Package: Tape & Reel (mm)

