

Customer Code : _____

DATASHEET

DAPU P/N : **O11F-K311-38.40MHz-A**

Customer P/N: _____

DAPU			Customer Approval
Drew	Audited	Approved	Stamp, please! Thanks!
Date: 2024.04.11			

Guangdong Dapu Telecom Technology Co.,Ltd

Building 5, No.24, Industrial East Road, Songshanhu Park, Dongguan, Guangdong, P.R. China

TEL: 0086-0769-88010888 FAX: 0086-0769-81800098



1. Electrical Parameters

MODEL: O11F-K311-38.40MHz-A						
Item	Description	Parameters			Unit	Test Condition
		Min.	Typ.	Max.		
Output	Frequency	38.40			MHz	
	Output Waveform	LVCMOS				
	Output Low Voltage			0.4	V	$V_{cc}=3.3V, O_{load}=15pF$
	Output High Voltage	2.4			V	$V_{cc}=3.3V, O_{load}=15pF$
	Duty Cycle	48.6	50	51.5	%	@50%
	Rise / Fall Time (10%~90%)			10	ns	
	Load	15			pF	
Frequency Stabilities	Frequency Tolerance vs. Operating Temperature Range	-0.01		+0.01	$\times 10^{-6}$	T_A varied from $-40^{\circ}C$ to $95^{\circ}C$, measurement referenced to frequency observed with $f_{ref}=(f_{max}+f_{min})/2$, $V_{cc}=3.3V$, $V_c=1.65V, O_{load}=15pF$, temperature variable speed less than $2^{\circ}C$ per minute.
	Initial Frequency Tolerance	-1		+1	$\times 10^{-6}$	Measurement referenced to frequency observed with $T_A=25^{\circ}C$, $V_{cc}=3.3V$, $V_c=1.65V$, and after 15 minutes of operation, within 30 days after ex-works.
	Frequency Tolerance vs. Supply Voltage	-5		+5	$\times 10^{-9}$	measurement referenced to frequency observed $T_A=25^{\circ}C$, V_{cc} varied from 3.13V to 3.47V, $V_c=1.65V$ and $O_{Load}=15pF$.
	Frequency Tolerance vs. Load	-5		+5	$\times 10^{-9}$	5% load change measurement referenced to frequency observed with $T_A=25^{\circ}C$, $V_{cc}=3.3V, V_c=1.65V$, and $O_{Load}=15pF$.
	Frequency slope	-1.5		+1.5	$\times 10^{-9}/^{\circ}C$	Temperature ramp $\leq 1^{\circ}C$ /minute, $\Delta F/\Delta T$ in still air
	Reflow shift	-0.5		+0.5	$\times 10^{-6}$	After 1 hour recovery at $25^{\circ}C$
	Aging Tolerance Per Day	-2		+2	$\times 10^{-9}$	V_{cc}, V_c, T_A constant measurement referenced to frequency observed with $T_A=25^{\circ}C, V_{cc}=3.3V, V_c=1.65V$, and after 30 days of operation.
	Aging Tolerance 1 Year	-0.5		+0.5	$\times 10^{-6}$	
	Aging Tolerance 10 Year	-3		+3	$\times 10^{-6}$	



Power Supply	Supply Voltage	3.13	3.3	3.47	V	
	Steady Consumption			230	mA	@25°C
	Warm up current			500	mA	
	Warm-Up Time			3	min	@25°C, within $\pm 0.1 \times 10^{-6}$ of final frequency with reference after 1 hour on.
Voltage Control Characteristics	Frequency Tuning Range	-5		-3	$\times 10^{-6}$	$V_c=0V$. measurement referenced to $V_c=1.65V$
		-1		+1	$\times 10^{-6}$	$V_c=1.65V$. measurement referenced to Exactly38.40MHz
		+3		+5	$\times 10^{-6}$	$V_c=3.3V$. measurement referenced to $V_c=1.65V$
	Linearity			10	%	
	Slope	Positive				
	Input Impedance	100			K Ω	
Phase Noise	Phase Noise		-65		dBc/Hz	1Hz
			-100			10Hz
			-135			100Hz
			-145			1KHz
			-150			10KHz
			-150			100KHz
			-150			1MHz
Environmental Conditions	Operable Temperature	-40		+95	°C	
	Storage Temperature	-55		+105	°C	
	ESD Level	Human Body Model, class2: 2000V to 4000V; ANSI/ESDA/JEDEC JS-001-2010.				
		Machine Model, class B: 200V to 400V; JEDEC JESD22-A115C.				
	Moisture Sensitivity Level	Level 2.				
	Vibration	Test Condition: 0.75mm ;acceleration:10g;10Hz~500Hz, one cycle per 30 min, test 2 hour. (3 times for each 3 directions X ,Y , Z), IEC 68-2-06 Test Fc.				
Shock	50g; 11ms; half sine wave (3 times for each 3 directions X, Y, Z), IEC 68-2-27 Test Ea/Severity 50A.					
Full Package Storage	Relative humidity (%)	20% ~ 70%				
	Temperature (°C)	-10~35°C				



2. Mechanical Structure (mm)

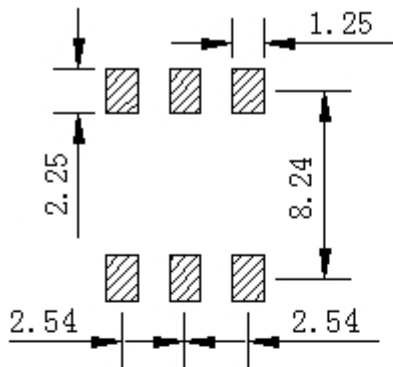

Solder Pad layout

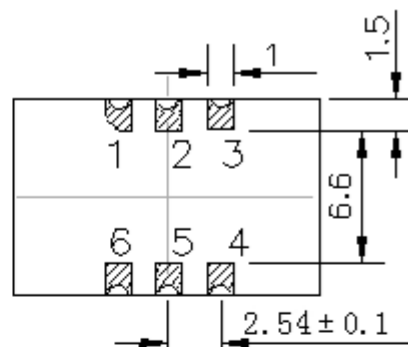

Bottom view

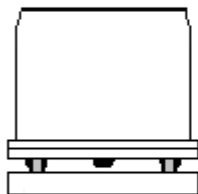

Right view

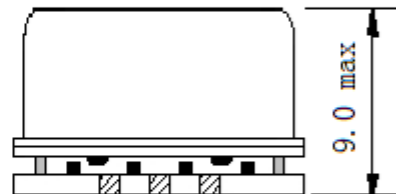

Side view

PIN FUNCTION

PIN	FUNCTION
1	VC
2,5	NC
3	GND
4	OUTPUT
6	VCC

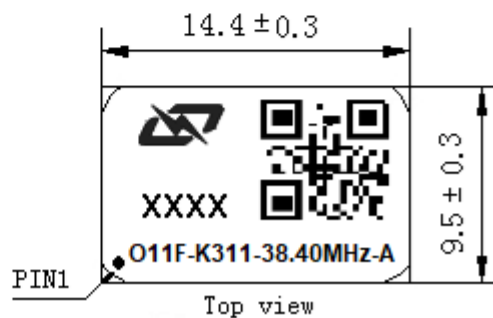

Top view

Note1: Tolerance ± 0.2mm without mark

Note2: The first two xx representative: week
After two xx representative: year

Note3: Referential weight 2.2g

Note4: NC is not connect



3. Test Circuit

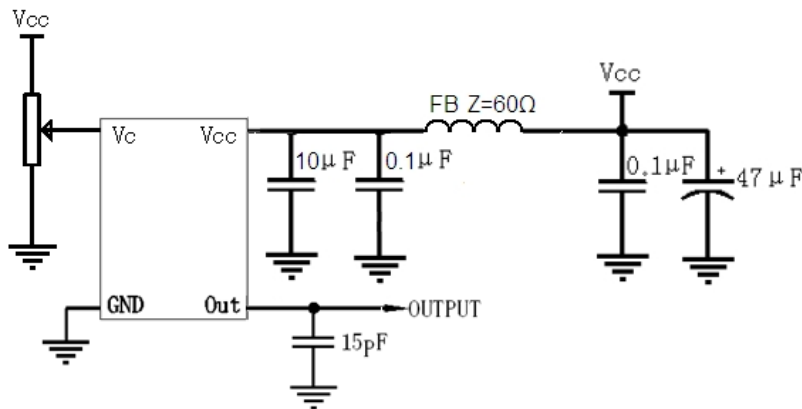

4. Reflow Soldering Curve (RoHS)

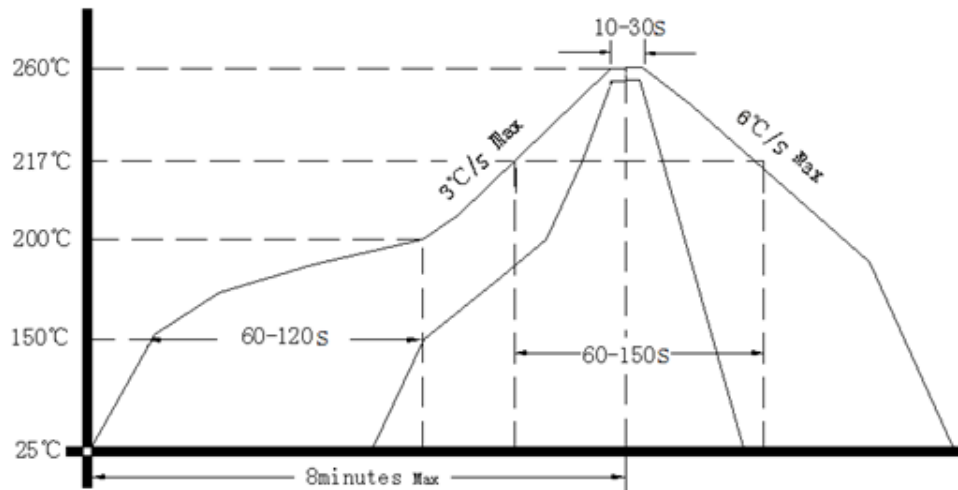

Note: Passing through reflow upside down is not supported

5. Package: Tape & Reel (mm)

