

Customer Code : _____

DATASHEET

DAPU P/N: **T53-F519-19.20MHz**

Customer P/N: _____

DAPU			Customer Approval
Drew	Audited	Approved	Stamp, please! Thanks!
Date: 2016.04.15			

Guangdong Dapu Telecom Technology Co.,Ltd

Bldg 16,.N.Ind.Zone,SSL Industry Park, Dongguan City, Guangdong Province, China

TEL: 0086-0769-88010888 FAX: 0086-0769-81800098



1. Electrical Parameters

MODEL: T53-F519-19.20MHz						
Item	Description	Parameters			Unit	Test Condition
		Min.	Typ.	Max.		
Output	Frequency	19.20			MHz	
	Output Waveform	Clipped Sine Wave				
	Vp-p	0.8			V	
	Load	10KΩ//10pF				
Frequency Stabilities	Frequency Tolerance vs. Operating Temperature Range	-0.5		+0.5	$\times 10^{-6}$	T_A varied from -40 to 85°C, measurement referenced to frequency observed with $f_{ref}=(f_{max}+f_{min})/2$, $V_{cc}=3.3V$, $O_{load}=10K\Omega//10pF$, temperature variable speed less than 2°C per minute.
	Initial Frequency Tolerance	-0.5		+0.5	$\times 10^{-6}$	Measurement referenced to frequency observed with $T_A=25^\circ C$, $V_{cc}=3.3V$ within 30 days after ex-works.
	Frequency Tolerance vs. Supply Voltage	-0.1		+0.1	$\times 10^{-6}$	measurement referenced to frequency observed $T_A=25^\circ C$, V_{cc} varied from 3.13V to 3.47V, and $O_{Load}=10K\Omega//10pF$.
	Frequency Tolerance vs. Load	-0.1		+0.1	$\times 10^{-6}$	5% load change measurement referenced to frequency observed with $T_A=25^\circ C$, $V_{cc}=3.3V$, $O_{Load}=10K\Omega//10pF$.
	Aging Tolerance Per Day	-0.02		+0.02	$\times 10^{-6}$	$T_A=25^\circ C$, $V_{cc}=3.3V$, and after 1h of operation.
	Aging Tolerance 1 Year	-1		+1	$\times 10^{-6}$	
Power Supply	Current Consumption			6	mA	@25°C, $V_{cc}=3.3V$, $O_{load}=10K\Omega//10pF$.
	Supply Voltage	3.13	3.3	3.47	V	
Phase Noise	Phase Noise @25°C		-85	-80	dBc/Hz	10Hz
			-115	-110		100Hz
			-135	-130		1KHz
			-145	-140		10KHz
			-150	-145		100KHz
			-150	-145		1MHz



Environmental Conditions	Operable Temperature	-40	+85	°C	
	Storage Temperature	-55	+105	°C	
	ESD Level	Human Body Model, class2: 2000V to 4000V; ANSI/ESDA/JEDEC JS-001-2010.			
		Machine Model, class B: 200V to 400V; ANSI/ESDA/JEDEC JS-001-2010.			
	Moisture Sensitivity Level	Level 2.			
	Vibration	Test Condition: 0.75mm ;acceleration:10g;10Hz~2000Hz, one cycle per 30 min, test 2 hour. (3 times for each 3 directions X , Y , Z) .IEC 68-2-06 Test Fc.			
Shock	100g; 6ms; half sine wave (3 times for each 3 directions X , Y , Z),IEC 68-2-27 Test Ea/Severity 50A.				
Full Package Storage	Relative humidity (%)	20%~70%			
	Temperature (°C)	-10~35°C			

2. Mechanical Structure(mm)

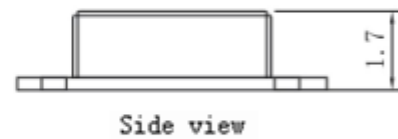
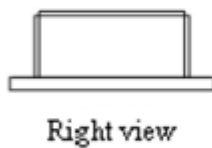
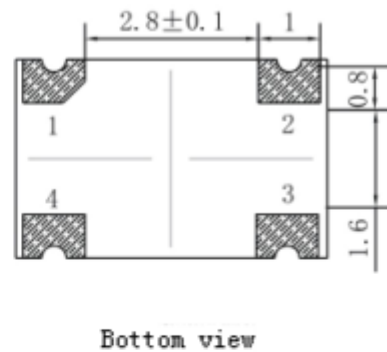
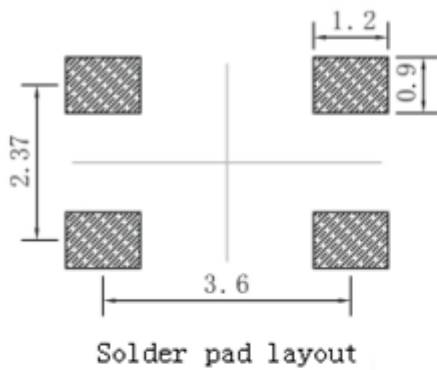

PIN FUNCTION

PIN	NOTATION	FUNCTION
1	NC	Not Connect
2	GND	GND
3	OUTPUT	RF Output
4	VCC	Supply Voltage

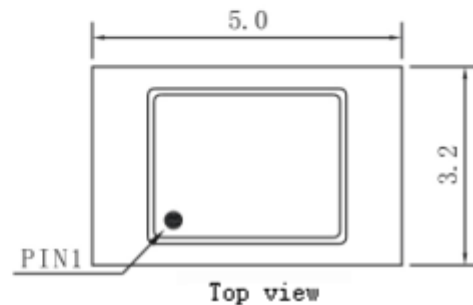

Note1: Tolerance ±0.20mm without mark

Note2: Referential Weight 0.05g

Note3: NC is not connect



3. Test circuit

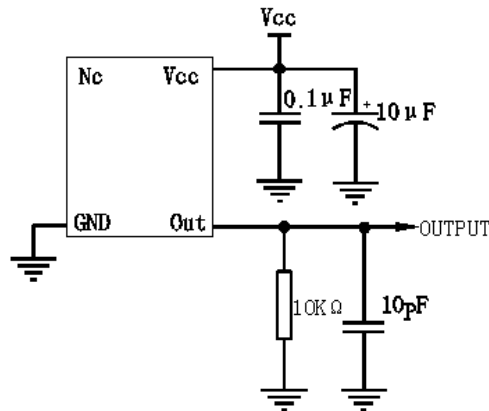

4. Reflow Soldering Curve (RoHS)

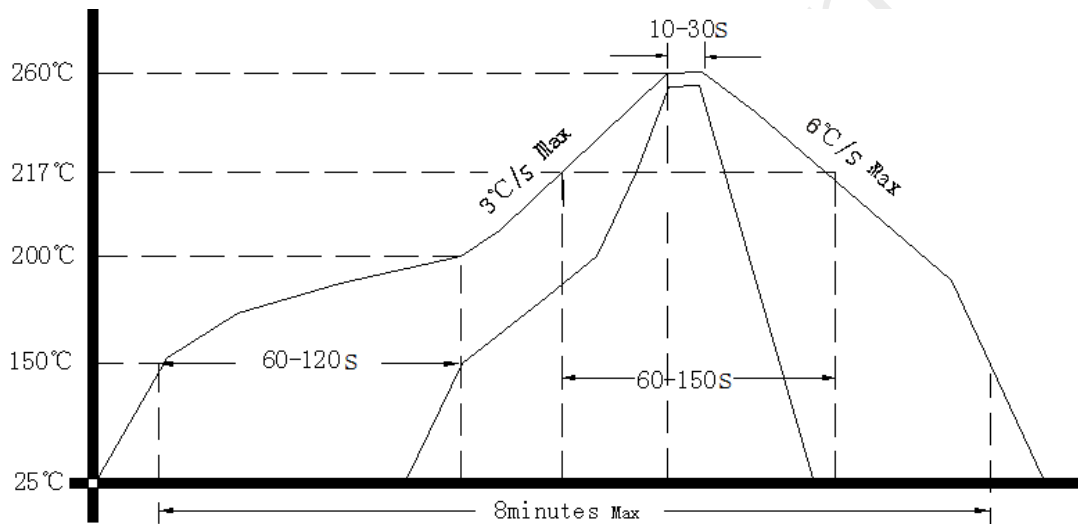

Note: If soldering with a hot air gun, ensure the temperature < 320°C , soldering time < 15 seconds.

5. Package: Tape & Reel (mm)

