

Customer Code : _____

DATASHEET

DAPU P/N: **T53-Y519-10.00MHz**

Customer P/N: _____

DAPU			Customer Approval
Drew	Audited	Approved	Stamp, please! Thanks!
Date: 2023.02.03			

Guangdong Dapu Telecom Technology Co.,Ltd

Building 5, No.24, Industrial East Road, Songshanhu Park, Dongguan, Guangdong, P.R. China

TEL: 0086-0769-88010888 FAX: 0086-0769-81800098



Table of amendment

Version	Revision contents	Prepared by	Revised date
1.0	The first issued	<i>Amway</i>	2019.09.27
1.1	The “Supply Voltage” “ESD Level” changed	<i>Amway</i>	2022.08.10
1.2	The “Phase Noise” changed	<i>Amway</i>	2023.02.03



1. Electrical Parameters

MODEL: T53-Y519-10.00MHz						
Item	Description	Parameters			Unit	Test Condition
		Min.	Typ.	Max.		
Output	Frequency	10.00			MHz	
	Output Waveform	Clipped Sine Wave				
	Vp-p	0.8			V	
	Load	10KΩ//10pF				
Frequency Stabilities	Frequency Tolerance vs. Operating Temperature Range	-0.28		+0.28	$\times 10^{-6}$	T_A varied from -40°C to 85°C , measurement referenced to frequency observed with $f_{\text{ref}}=(f_{\text{max}}+f_{\text{min}})/2$, $V_{\text{cc}}=3.3\text{V}$, $O_{\text{load}}=10\text{K}\Omega//10\text{pF}$, temperature variable speed less than 2°C per minute.
	Initial Frequency Tolerance	-1		+1	$\times 10^{-6}$	Measurement referenced to frequency observed with $T_A=25^{\circ}\text{C}$, $V_{\text{cc}}=3.3\text{V}$, within 30 days after ex-works.
	Frequency Tolerance vs. Supply Voltage	-0.1		+0.1	$\times 10^{-6}$	measurement referenced to frequency observed $T_A=25^{\circ}\text{C}$, V_{cc} varied from 3.13V to 3.47V, $O_{\text{Load}}=10\text{K}\Omega//10\text{pF}$.
	Frequency Tolerance vs. Load	-0.2		+0.2	$\times 10^{-6}$	10% load change measurement referenced to frequency observed with $T_A=25^{\circ}\text{C}$, $V_{\text{cc}}=3.3\text{V}$, $O_{\text{Load}}=10\text{K}\Omega//10\text{pF}$.
	Aging Tolerance Per Day	-0.02		+0.02	$\times 10^{-6}$	$T_A=25^{\circ}\text{C}$, $V_{\text{cc}}=3.3\text{V}$, and after 1h of operation.
	Aging Tolerance 1 Year	-1		+1	$\times 10^{-6}$	
Power Supply	Operating Current			10	mA	@ 25°C , $V_{\text{cc}}=3.3\text{V}$, $O_{\text{Load}}=10\text{K}\Omega//10\text{pF}$.
	Supply Voltage	2.5		3.6	V	
Phase Noise	Phase Noise @ 25°C		-90		dBc/Hz	10Hz
			-120			100Hz
			-140			1KHz
			-150			10KHz
			-150			100KHz
			-150			1MHz



Environmental Conditions	Operable Temperature	-40		+85	°C	
	Storage Temperature	-55		+105	°C	
	ESD Level	Human Body Model,class2: 2000V to 4000V; ANSI/ESDA/JEDEC JS-001-2010.				
		Machine Model, class B: 200V to 400V; JEDEC JESD22-A115C.				
	Moisture Sensitivity Level	Level 3.				
	Vibration	Test Condition: 0.75mm ;acceleration:10g;10Hz~2000Hz, one cycle per 30 min, test 2 hour. (3 times for each 3 directions X ,Y , Z) .IEC 68-2-06 Test Fc.				
Shock	100g; 6ms; half sine wave (3 times for each 3 directions X ,Y , Z),IEC 68-2-27 Test Ea/Severity 50A.					
Full Package Storage	Relative humidity (%)	20%~70%				
	Temperature (°C)	-10~35°C				

2. Mechanical Structure(mm)

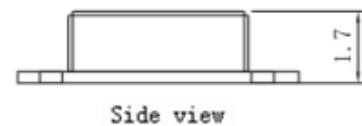
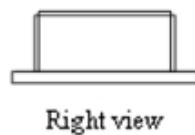
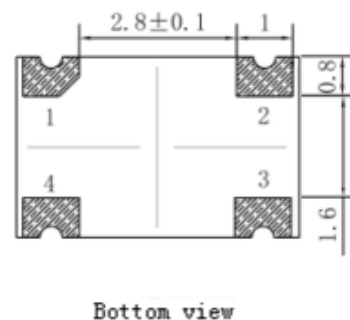
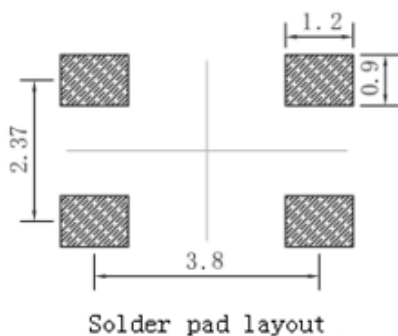

PIN FUNCTION

PIN	NOTATION	FUNCTION
1	NC	Not Connect
2	GND	GND
3	OUTPUT	RF Output
4	VCC	Supply Voltage

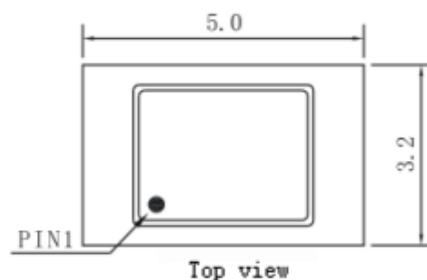

Note1: Tolerance $\pm 0.2\text{mm}$ without mark

Note2: Referential Weight 0.05g



3. Test Circuit

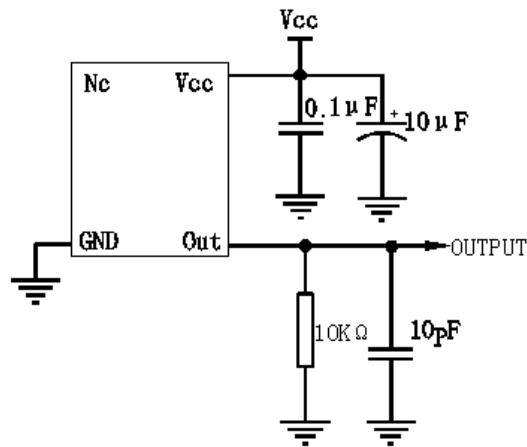

4. Reflow Soldering Curve (RoHS)

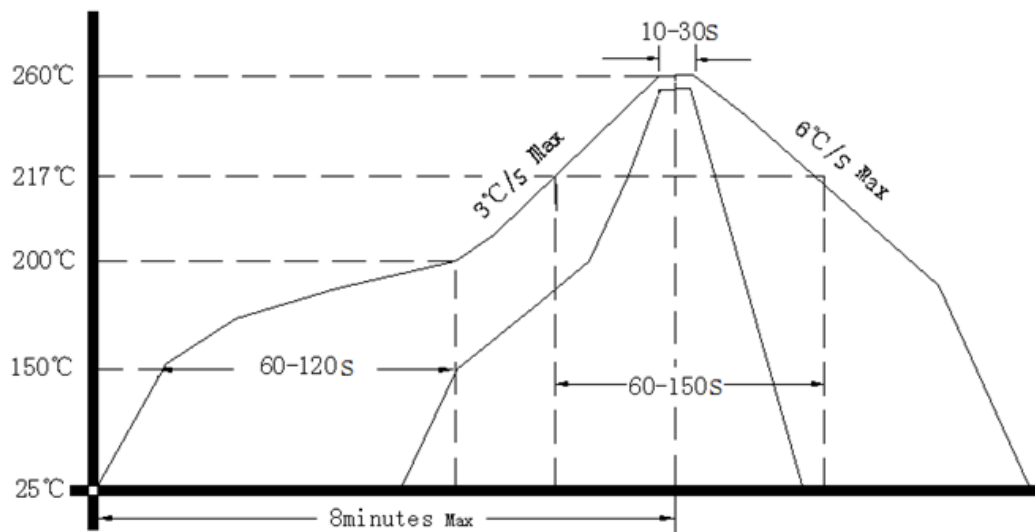

5. Package: Tape & Reel (mm)

