

Customer Code: _____

DATASHEET

DAPU P/N: DPZ7566M666033A0

DAPU			Customer Approval
Drew	Audited	Approved	Stamp, please! Thanks!
Jack	David	William	
Date: 2022.2.23			

Guangdong Dapu Telecom Technology Co.,Ltd

Building 5, No.24, Industrial East Road, Songshanhu Park, Dongguan, Guangdong, P.R. China

TEL: 0086-0769-88010888 FAX: 0086-0769-81800098



1、 Electrical Parameters

MODEL: DPZ7566M666033A0							
No.	Parameters	SYM.	Electrical Spec.				Notes
			Min.	Typ.	Max.	Units	
1	Nominal Frequency	FL	66.666			MHz	
2	Frequency Tolerance	-	-20		+ 20	$\times 10^{-6}$	At 25°C
3	Frequency Stability	-	-50		+ 50	$\times 10^{-6}$	Over Operating Temperature Range
4	Operating Temperature	Topr	-40	~	+ 85	°C	
5	Storage Temperature	Tstg	-55	~	+ 125	°C	
6	Supply Voltage	V _{DD}	2.97	3.3	3.63	V	
7	Input Current	I _{cc}			10	mA	
8	Output waveform	-	CMOS				
9	Output Load	CL	15			pF	
10	Output Voltage High	V _{OH}	90%			V _{DD}	
11	Output Voltage Low	V _{OL}			10%	V _{DD}	
12	Rise/Fall Time	Tr、 Tf			5	ns	20%-80% V _{DD} Level
13	Aging	-	-3		+ 3	$\times 10^{-6}$	First Year at 25°C
14	Tri-State Output Enable	-	70%			V _{DD}	Pin 1, OE
15	Tri-State Output Disable	-			30%	V _{DD}	Pin 1, OE
16	Duty Cycle	-	45	~	55	%	
17	Start-Up Time	Tstart			5	ms	Measured from the time V _{DD} reaches its rated minimum value



2、Mechanical Structure(mm)

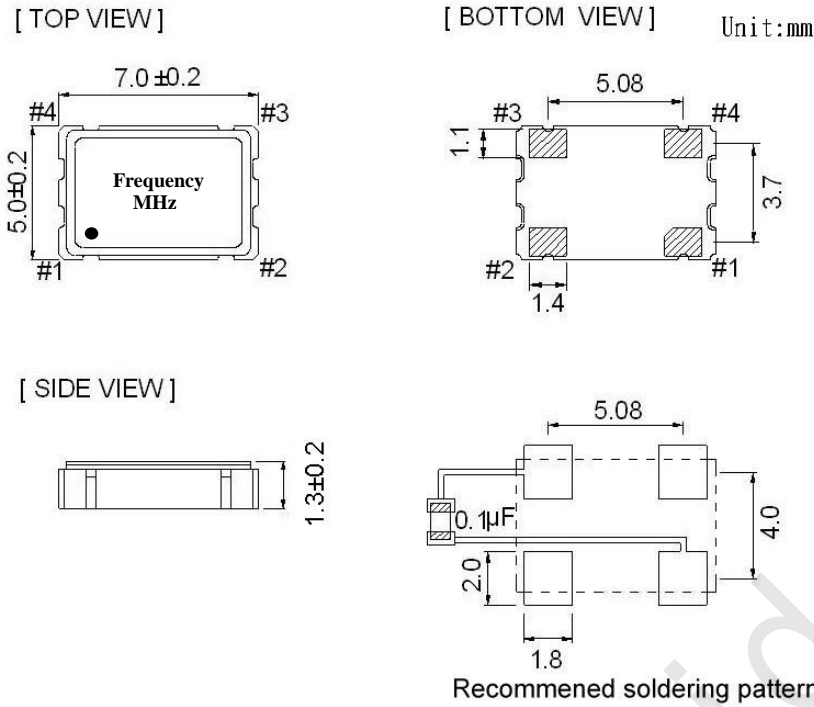

Pin	Function
#1	Tri-State
#2	GND
#3	Output
#4	VDD

Pin Functions

Note1:Tolerance ± 0.2 mm without mark

3、Test Circuit

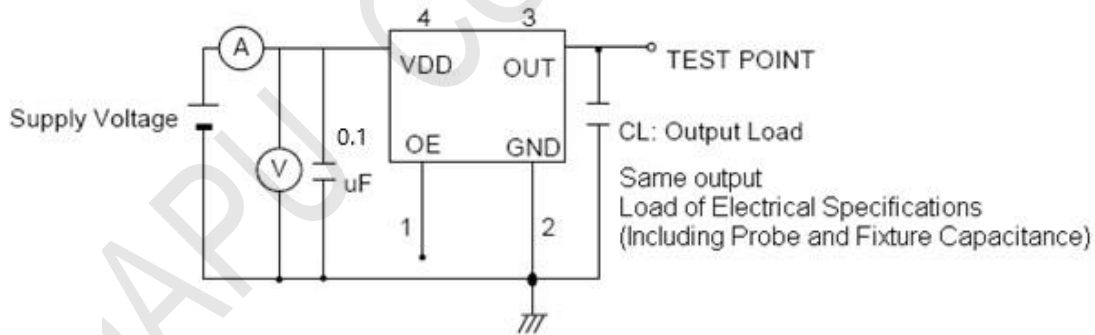

Control input (output enable/disable)

Logic 1 or open on pad 1: Oscillator output

Logic 0 on pad 1 : Disable output to high impedance



4、 Output Waveform(CMOS Load)

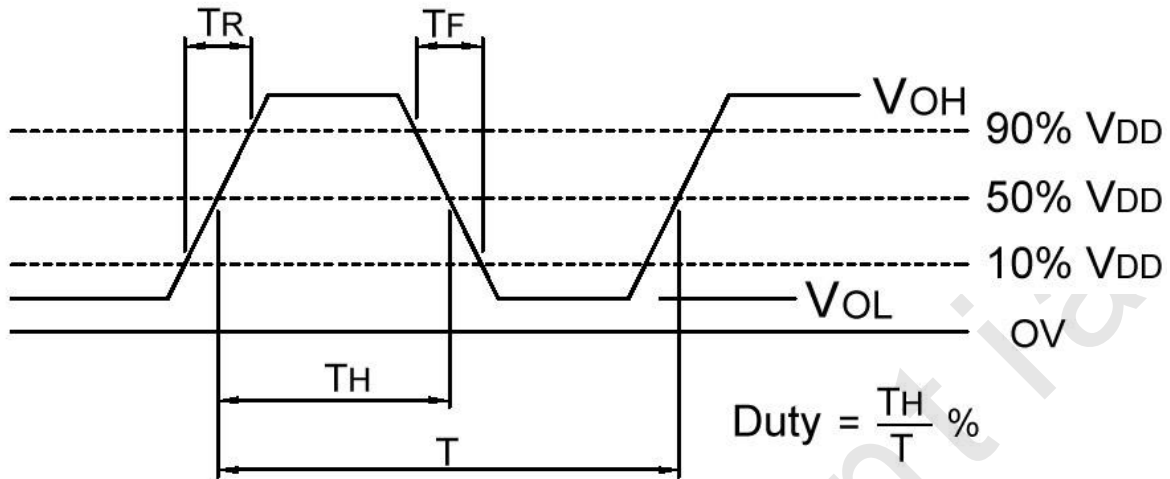

5、 Reflow Soldering Curve (RoHS)

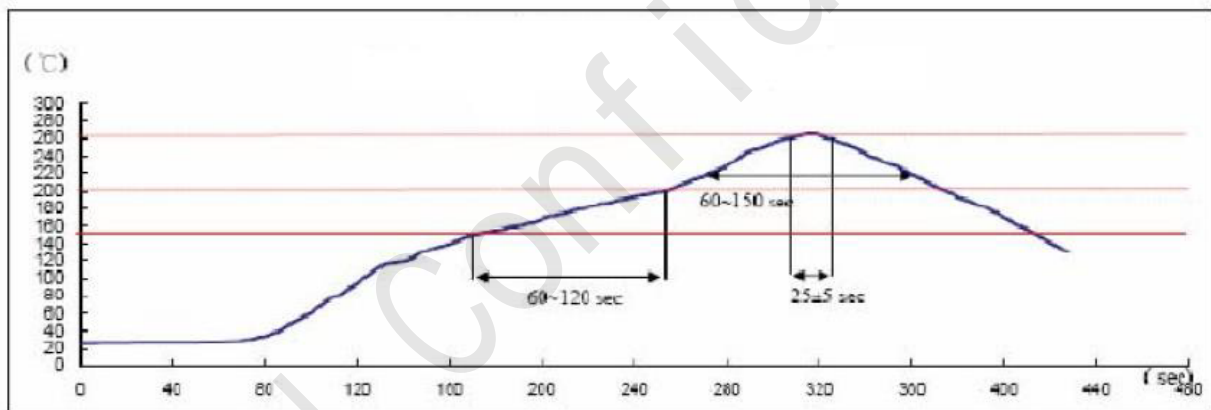

IR-Reflow Test

Reference Standard : JEDEC-STD 020

Test Conditions: Pre-heating : 150°C to 200 °C , 60~120 sec

Heating : 217 °C , 60~150 sec

Peak Temperature : 260±5 °C , 25±5 sec



6、 Package: Tape & Reel (mm)

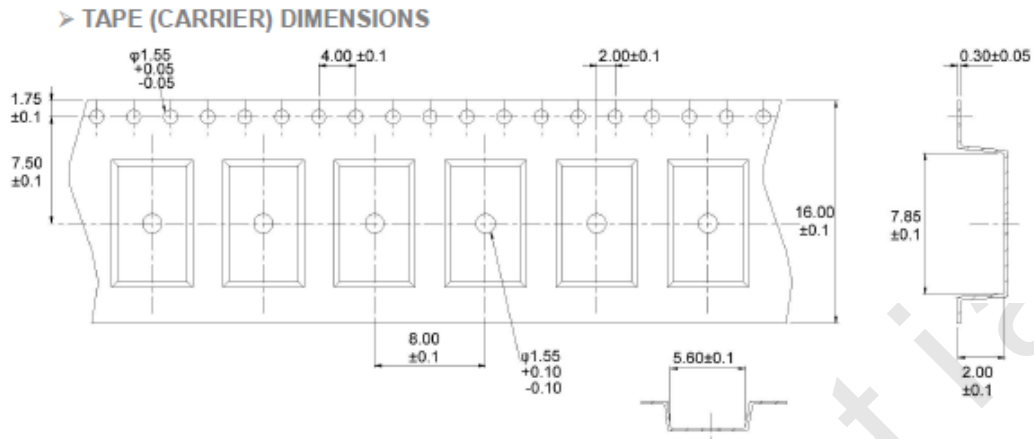

➤ THE DIRECTION OF PACKING

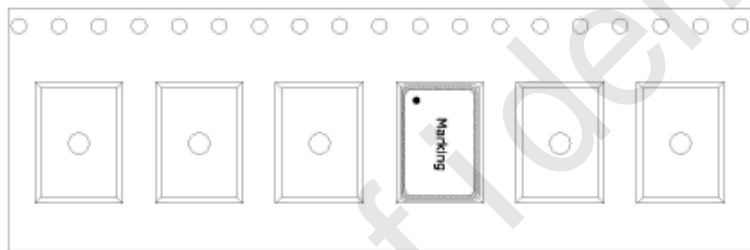

➤ REEL DIMENSIONS

