

Customer Code: _____

DATASHEET

DAPU P/N: DPA53125M000ED0CNA0

DAPU			Customer Approval
Drew	Audited	Approved	
Jieshu ZHENG	Jianhua LIN	Gangtao FENG	
Date:	2024/6/21		

Stamp, please! Thanks!

Guangdong Dapu Telecom Technology Co.,Ltd

Bldg 5, SSL Modern Enterprise Accelerator Zone, Dongguan City, Guangdong Province, PRC China
TEL: 0086-0769-88010888 FAX: 0086-0769-81800098

1、Electrical Parameter

MODEL :		DPA53125M000ED0CNA0					
No.	Parameters	SYM.	Electrical Spec.				Notes
			Min.	Typ.	Max.	Units	
1	Nominal Frequency	FL	125.000			MHz	
2	Oscillation Mode	-	3rd				
3	Frequency Tolerance	-	-10		10	ppm	At 25°C
4	Frequency Stability	-	-20		20	ppm	-40°C~85°C (Reference 25°C)
5	Operating Temperature	Topr	-40		85	°C	
6	Storage Temperature	Tstg	-55		125	°C	
7	Supply Voltage	VDD	1.62	3.3	3.63	V	V _{DD} ±5%
8	Input Current	Icc			25	mA	
9	Output waveform	-	CMOS				
10	Output Load	CL		15		pF	
11	Output Voltage High	VOH	0.9			VDD	
12	Output Voltage Low	VOL			0.1	VDD	
13	Rise Time	Tr			5	ns	10% -90% V _{DD} Level
14	Fall Time	Tf			5	ns	90% -10% V _{DD} Level
15	Aging	-	-3		3	ppm	First Year at 25°C
16	Tri-State Output Enable	-	0.7			VDD	Pin 1, OE or ST
17	Tri-State Output Disable	-			0.3	VDD	Pin 1, OE or ST
18	Duty Cycle	-	40~60			%	
19	Start-Up Time	Tstart			2	ms	Measured from the time VDD reaches its rated minimum value.

2、 Mechanical Structure

2.1 Dimensions

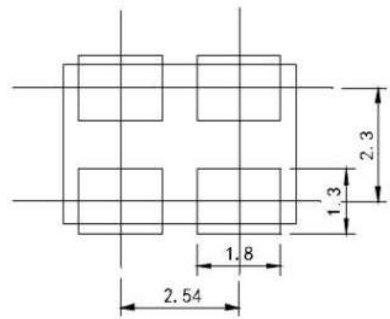
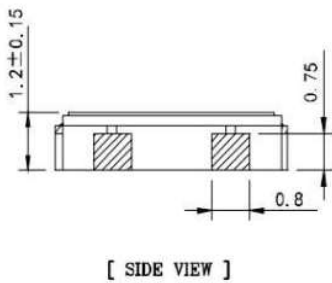
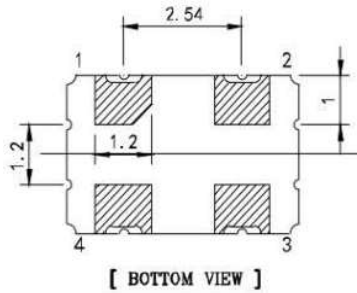
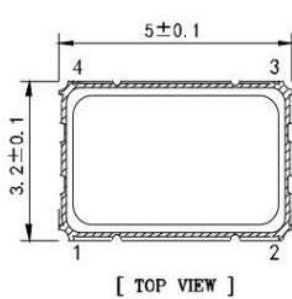

PIN1	Tri-state
PIN2	GND
PIN3	Output
PIN4	V _{DD}

2.2 Marking

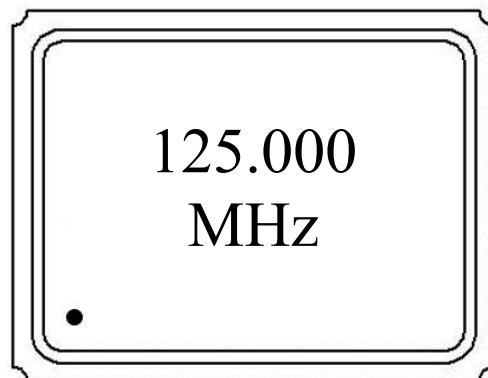

● -----Pin 1

3、 Test Circuit

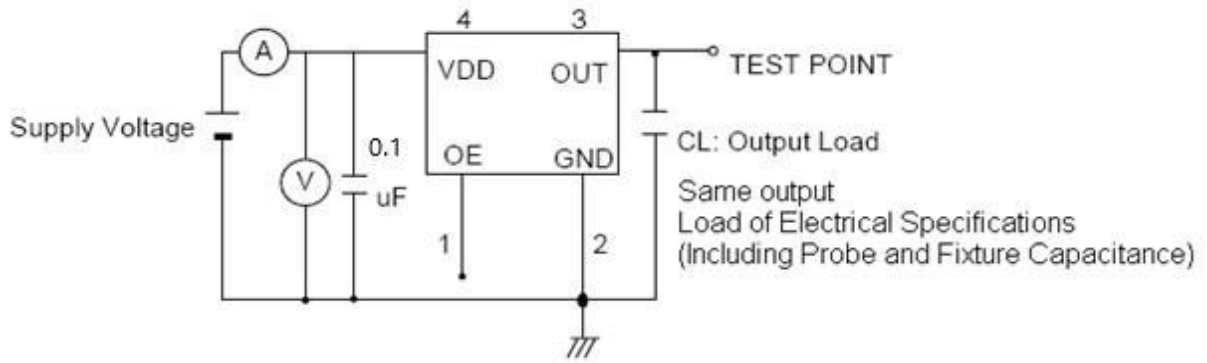

Control input (output enable/disable)

Tri-State Pin	Output Pin
Logic 1 or open on pad 1	Oscillator output
Logic 0 on pad 1	Disable output to high impedance

4、 Reflow Soldering Curve (RoHS)

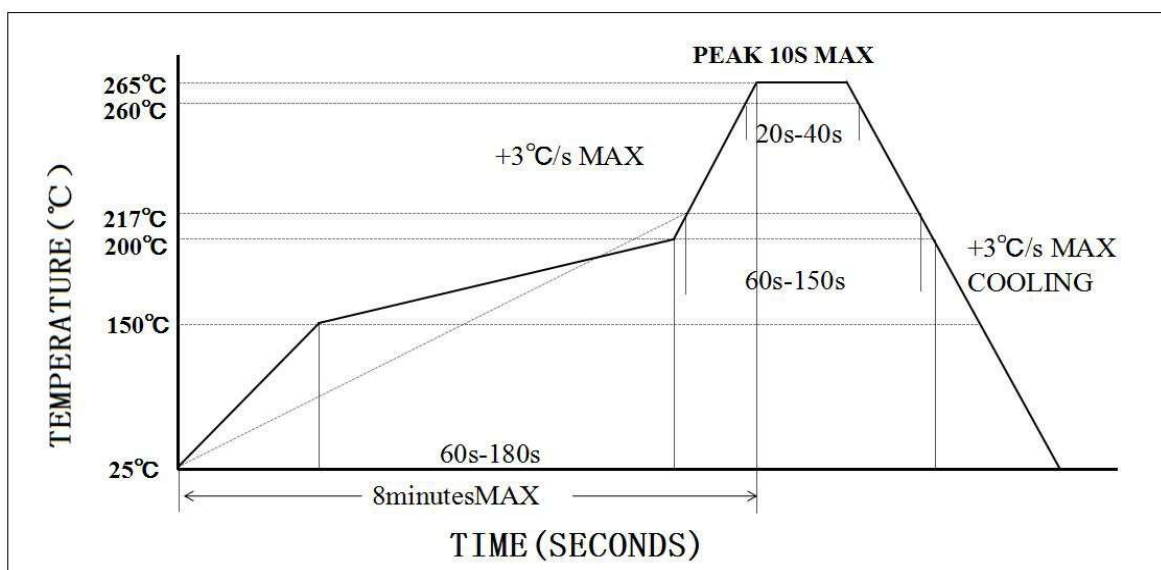

5、 Package: Tape & Reel (mm)

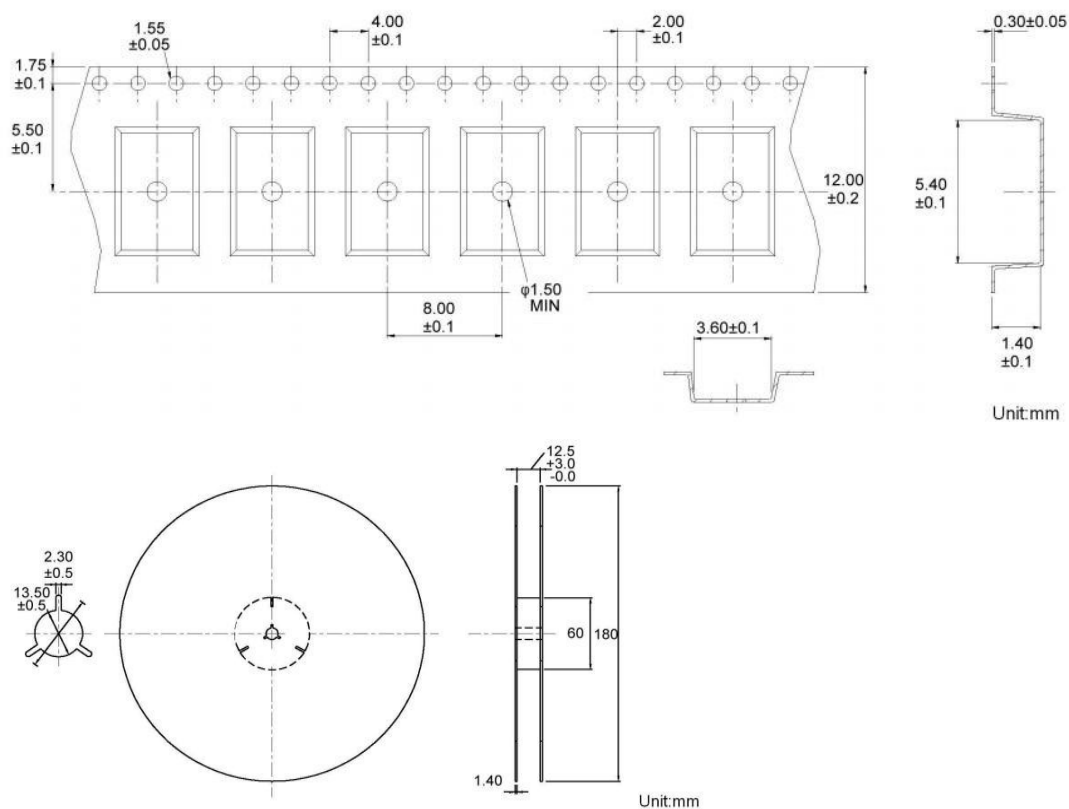

6、 Reliability Test Specification

NO.	Test Items	Test Standard	Test Condition	Standard
1	Drop test	GB/T2423.8	Drop from 150cm height on 3cm hard wooden board for 3 times	A、 C
2	Mechanical shock	GB/T2423.5	Peak: 100g; Waveform: Half-sine; Velocity Change: 1000m/s ² ; Duration: 0.5ms; 3 times/direction, Direction: +X, -X, +Y, -Y, +Z, -Z.	A、 C
3	Vibration	GB/T2423.10	Frequency: 10~2000Hz; Vibration:20min, 1.52mm; Direction: X, Y, Z; Duration: 2 hours/direction.	A、 C
4	Solderability	IEC60068-2-58	Soldering temperature:245°C±5°C Immersion time:5 seconds ± 0.5 seconds Flux:Rosin Resin Methanol Solvent (1 : 4)	E

NO.	Test Items	Test Standard	Test Condition	Standard
5	Resistance to soldering heat	IEC60068-2-58	Reflow soldering: Solder temperature 260±5°C, Immersion time:10±1S	A、C、D
6	High temperature storage	GB/T2423.2	Temperature: 125°C±2°C; Duration: 500±12hours;	A、C、D
7	Low temperature storage	GB/T2423.1	Temperature: -40°C±2°C; Duration: 500±12hours;	A、C、D
8	Temperature Shock	GB/T2423.22	Do 10 cycles at the following temperature	A、C、D
			<p>The diagram illustrates a temperature shock cycle. The temperature starts at 25 °C, drops to -55 ± 3 °C, stays there for 30 minutes, then rises to +125 ± 3 °C, stays there for 30 minutes, and returns to 25 °C. The transition time between the high and low temperature plateaus is 10 minutes maximum. The entire sequence is labeled as '1 cycle'.</p>	
9	High temperature high humidity storage	GB/T2423.3	Temperature: 85°C±3°C; Humidity: 85%; Duration: 500hours;	A、C、D