

Customer Code : _____

DATASHEET

DAPU P/N: **T75A-0801-19.44MHz**

Customer P/N: _____

DAPU			Customer Approval
Drew	Audited	Approved	Stamp, please! Thanks!
Date: 2024.01.25			

Guangdong Dapu Telecom Technology Co.,Ltd

Building 5, No.24, Industrial East Road, Songshanhu Park, Dongguan, Guangdong, P.R. China

TEL: 0086-0769-88010888 FAX: 0086-0769-81800098



Table of amendment

Version	Revision contents	Prepared by	Revised date
1.0	The first issued	<i>Amway</i>	2020.03.30
1.1	The “Mechanical Structure” “Package: Tape & Reel” changed	<i>Amway</i>	2024.01.25



1. Electrical Parameters

MODEL: T75A-0801-19.44MHz							
Item	Description	Parameters			Unit	Test Condition	
		Min.	Typ.	Max.			
Output	Frequency	19.44			MHz		
	Output Waveform	HCMOS					
	Output Low Voltage			0.33	V	$V_{cc}=3.3V, O_{load}=15\text{ pF}$	
	Output High Voltage	2.97			V	$V_{cc}=3.3V, O_{load}=15\text{ pF}$	
	Duty Cycle	45	50	55	%	@50%	
	Rise / Fall Time (10%~90%)			8	ns	@25°C	
	Load	13.5	15	16.5	pF		
Frequency Stabilities	Frequency Tolerance vs. Operating Temperature Range	-0.28		+0.28	$\times 10^{-6}$	T_A varied from -40°C to 85°C, measurement referenced to frequency observed with $f_{ref}=(f_{max}+f_{min})/2, V_{cc}=3.3V, O_{load}=15\text{ pF}$, temperature variable speed less than 2°C per minute.	
	Initial Frequency Tolerance	-1		+1	$\times 10^{-6}$	Measurement referenced to frequency observed with $T_A=25^\circ\text{C}, V_{cc}=3.3V$ within 30 days after ex-works.	
	Frequency Tolerance vs. Supply Voltage	-0.1		+0.1	$\times 10^{-6}$	measurement referenced to frequency observed $T_A=25^\circ\text{C}, V_{cc}$ varied from 3.135V to 3.465V, and $O_{Load}=15\text{ pF}$.	
	Frequency Tolerance vs. Load	-0.1		+0.1	$\times 10^{-6}$	5% load change measurement referenced to frequency observed with $T_A=25^\circ\text{C}, V_{cc}=3.3V, O_{Load}=15\text{ pF}$.	
	Holdover stability Constant Temperature		-0.01		+0.01	$\times 10^{-6}$	$T_A=25^\circ\text{C}, 24\text{ hours}$, after 10 days of continuous operation.
			-0.04		+0.04	$\times 10^{-6}$	$T_A=25^\circ\text{C}, 24\text{ hours}$, after 48 hours of continuous operation.
	Aging Tolerance 1 Year	-0.5		+0.5	$\times 10^{-6}$	$T_A=25^\circ\text{C}, V_{cc}=3.3V$, and after 1h of operation.	
	Aging Tolerance 20 Year	-3		+3	$\times 10^{-6}$		
Holdover stability (Free-run accuracy)	-4.6		+4.6	$\times 10^{-6}$			
Power Supply	Current Consumption			6	mA	@25°C, $V_{cc}=3.3V, O_{Load}=15\text{ pF}$.	
	Supply Voltage	3.135	3.3	3.465	V		



Phase Noise	Phase Noise @25°C		-85	-80	dBc/Hz	10Hz
			-115	-110		100Hz
			-135	-130		1KHz
			-145	-140		10KHz
			-150	-145		100KHz
			-152	-147		1MHz
Environmental Conditions	Operable Temperature	-40		+85	°C	
	Storage Temperature	-40		+90	°C	
	ESD Level	Human Body Model,class2: 2000V to 4000V; ANSI/ESDA/JEDEC JS-001-2010.				
		Machine Model, class B: 200V to 400V; JEDEC JESD22-A115C.				
	Moisture Sensitivity Level	Level 3.				
	Vibration	Test Condition: 0.75mm ;acceleration:10g;10Hz~2000Hz, one cycle per 30 min, test 2 hour. (3 times for each 3 directions X ,Y , Z) .IEC 68-2-06 Test Fc.				
Shock	100g; 6ms; half sine wave (3 times for each 3 directions X ,Y, Z),IEC 68-2-27 Test Ea/Severity 50A.					
Full Package Storage	Relative humidity (%)	20% ~70%				
	Temperature (°C)	-10~35°C				



2. Mechanical Structure(mm)

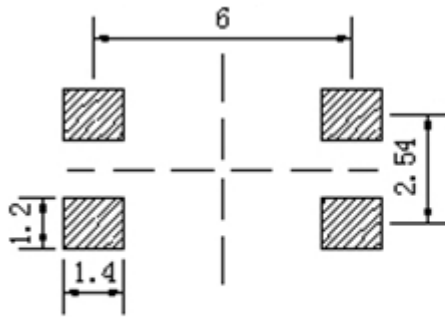

Solder pad layout

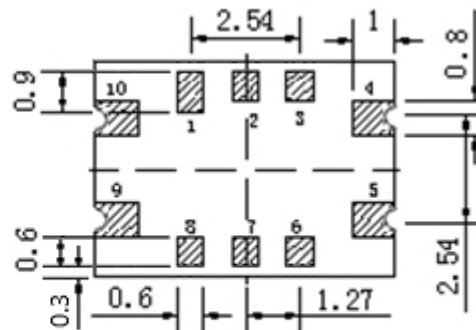

Bottom view

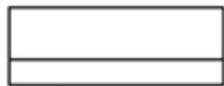

Right view

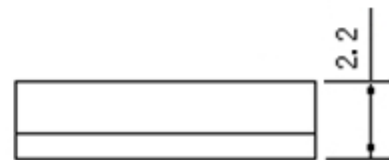

Front view

PIN FUNCTION

PIN	NOTATION	FUNCTION
1, 2, 3, 6, 7, 8	NC	Not Connect
4	GND	GND
5	OUTPUT	RF Output
9	VCC	Supply Voltage
10	NC	Not Connect

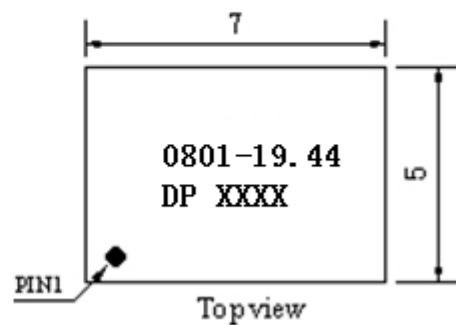

Top view

Note1: Tolerance $\pm 0.3\text{mm}$ without mark

Note2: The first two xx representative: week

After two xx representative: year

Note3: Referential Weight 0.2g

Note4: NC is not connect



3. Test circuit

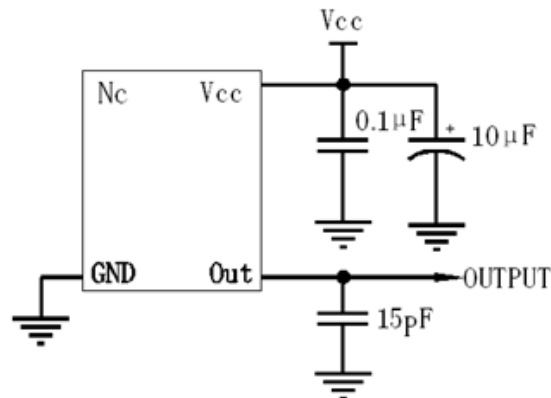

4. Reflow Soldering Curve (RoHS)

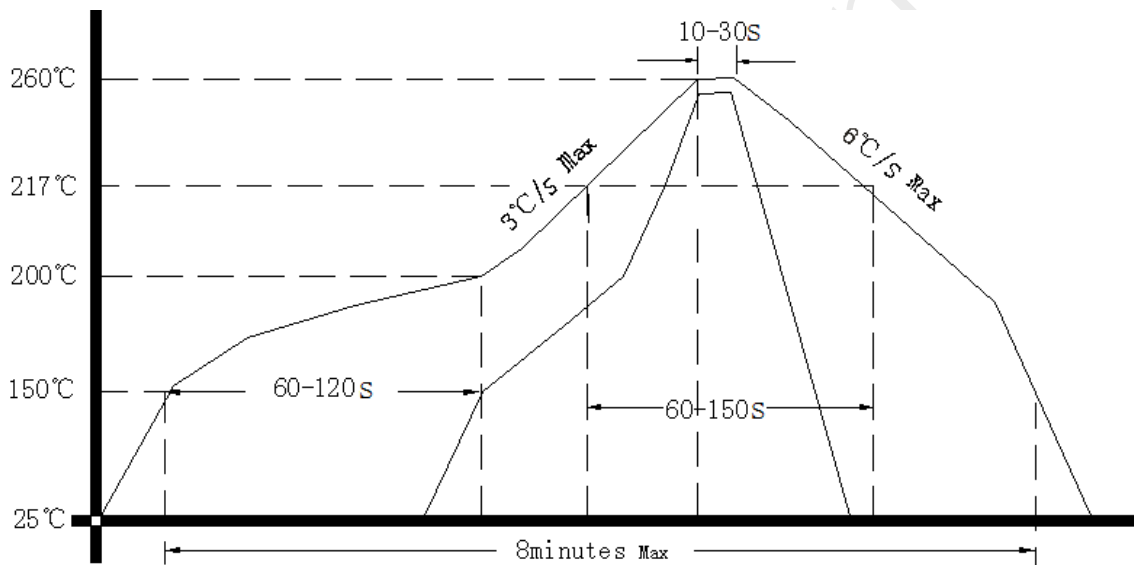

5. Package: Tape & Reel (mm)

