

Travelling Merchant: _____

DATASHEET

Standard: **T75B-0802-19.20MHz**

P/N: _____

Plot			The Label
Drew	Audited	Approved	Stamp, please! Thanks!
Date: 2020.06.12			

Guangdong Dapu Telecom Technology Co.,Ltd

Bldg13-16,.N.Ind.Zone,SSL Industry Park, Dongguan City, Guangdong Province, China

TEL: 0086-0769-88010888 FAX: 0086-0769-81800098



Table of amendment

Version	Revision contents	Prepared by	Revised date
1.0	The first issued	<i>Amway</i>	2020.06.12

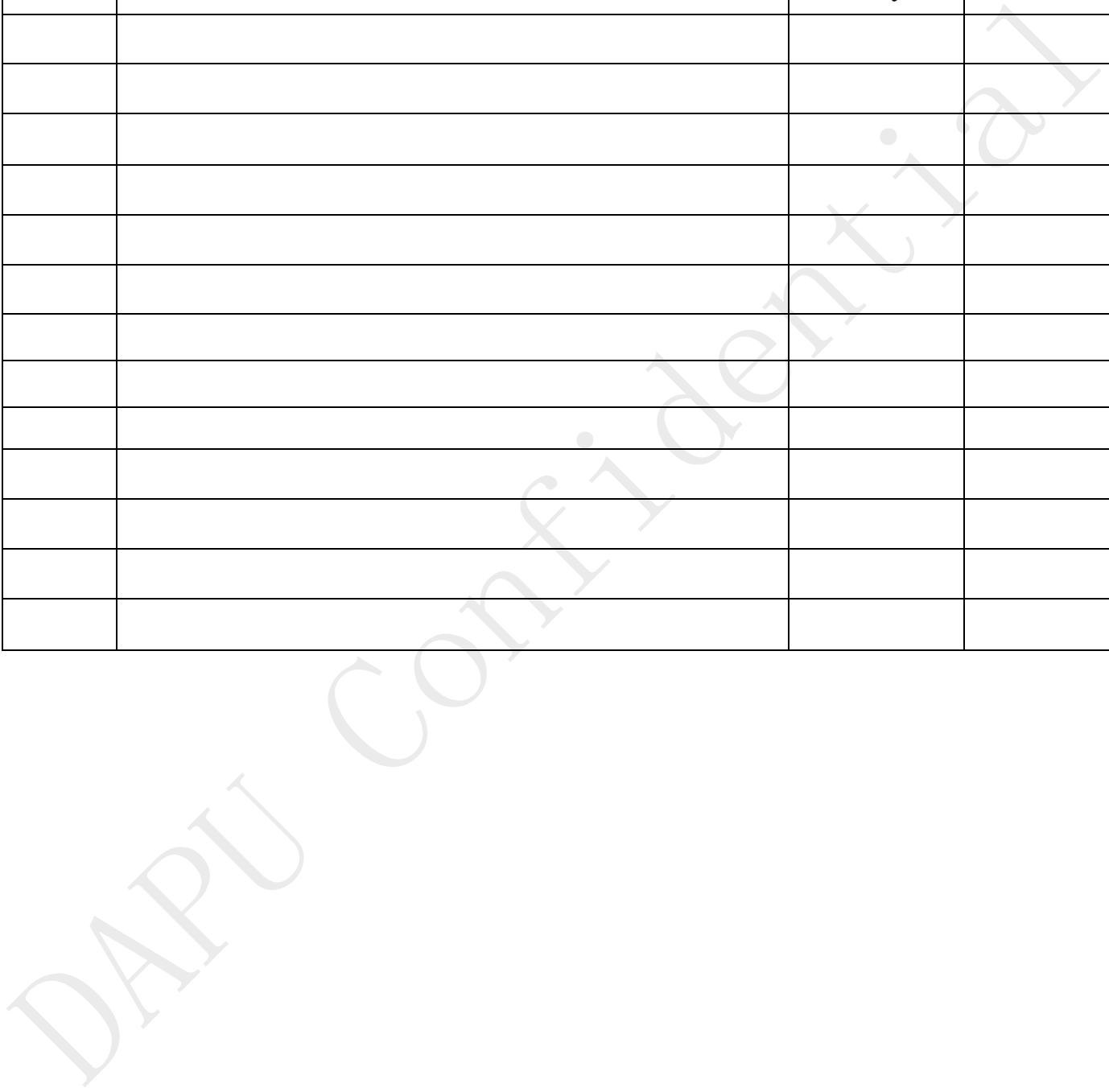



1. Electrical Parameters

MODEL: T75B-0802-19.20MHZ						
Item	Description	Parameters			Unit	Test Condition
		Min.	Typ.	Max.		
Output	Frequency	19.20			MHz	
	Output Waveform	HCMOS				
	Output Low Voltage			0.4	V	$V_{cc}=3.3V, O_{load}=15\text{ pF}$
	Output High Voltage	2.8			V	$V_{cc}=3.3V, O_{load}=15\text{ pF}$
	Duty Cycle	45		55	%	@50%
	Rise / Fall Time (10%~90%)			8	ns	@25°C
	Load		15	30	pF	
Frequency Stabilities	Frequency Tolerance vs. Operating Temperature Range	-0.28		+0.28	$\times 10^{-6}$	T_A varied from -40°C to 85°C, measurement referenced to frequency observed with $f_{ref}=(f_{max}+f_{min})/2, V_{cc}=3.3V, V_c=1.65V, O_{load}=15\text{ pF}$, temperature variable speed less than 2°C per minute.
	Initial Frequency Tolerance	-1		+1	$\times 10^{-6}$	Measurement referenced to frequency observed with $T_A=25^\circ\text{C}, V_{cc}=3.3V, V_c=1.65V$, within 30 days after ex-works.
	Frequency Tolerance After Reflow	-1		+1	$\times 10^{-6}$	2 times, Operation after reflow 2hrs, refer to nominal frequency.
	Frequency Tolerance vs. Supply Voltage	-0.3		+0.3	$\times 10^{-6}$	measurement referenced to frequency observed $T_A=25^\circ\text{C}, V_{cc}$ varied from 3.135V to 3.465V and $V_c=1.65V, O_{Load}=15\text{ pF}$.
	Frequency Tolerance vs. Load	-0.2		+0.2	$\times 10^{-6}$	10% load change measurement referenced to frequency observed with $T_A=25^\circ\text{C}, V_{cc}=3.3V, V_c=1.65V$, and $O_{Load}=15\text{ pF}$.
	Frequency Slope			0.05	$\times 10^{-6}/^\circ\text{C}$	Minimum of 1 frequency reading every 2°C over temperature, based on temperature varied and maximum of 2°C per minute.
	Aging Tolerance 1 Year	-1		+1	$\times 10^{-6}$	$T_A=25^\circ\text{C}, V_{cc}=3.3V, V_c=1.65V$ and after 1h of operation.
	Aging Tolerance 10 Year	-5		+5	$\times 10^{-6}$	



Power Supply	Operating Current			10	mA	@25°C, V _{cc} =3.465V, V _c =1.65V, O _{Load} =15 pF .
	Supply Voltage	3.135	3.3	3.465	V	
Voltage Control Characteristics	Frequency Tuning Range	-15		-10	× 10 ⁻⁶	V _c =0 V. measurement referenced to V _c =1.65V.
		-1		+1	× 10 ⁻⁶	V _c =1.65V. measurement referenced to Exactly 19.20MHz.
		+10		+15	× 10 ⁻⁶	V _c =3.3V. measurement referenced to V _c =1.65V.
	Linearity			10	%	
	Slope	Positive				
Input Impedance	100				KΩ	
Phase Noise	Phase Noise @25°C			-86	dBc/Hz	10Hz
				-110		100Hz
				-130		1KHz
				-144		10KHz
				-145		100KHz
RMS Jitter	RMS Jitter			1.7	ps	From 10Hz~1MHz
Environmental Conditions	Operable Temperature	-40		+85	°C	
	Storage Temperature	-40		+90	°C	
	ESD Level	Human Body Model,class2: 2000V to 4000V; ANSI/ESDA/JEDEC JS-001-2010.				
		Machine Model, class B: 200V to 400V; JEDEC JESD22-A115C.				
	Moisture Sensitivity Level	Level 3.				
	Vibration	Test Condition: 0.75mm ;acceleration:10g;10Hz~2000Hz, one cycle per 30 min, test 2 hour. (3 times for each 3 directions X , Y , Z) .IEC 68-2-06 Test Fc.				
Shock	100g; 6ms; half sine wave (3 times for each 3 directions X , Y , Z) ,IEC 68-2-27 Test Ea/Severity 50A.					
Full Package Storage	Relative humidity (%)	20% ~70%				
	Temperature (°C)	-10~35°C				



2. Mechanical Structure(mm)

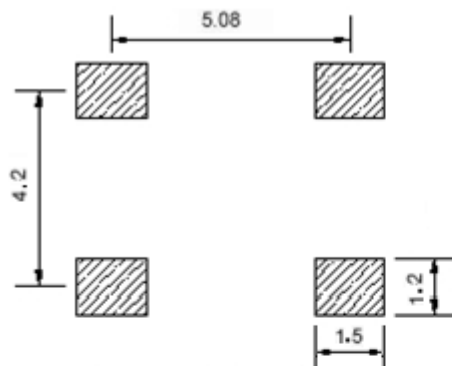

Solder pad layout

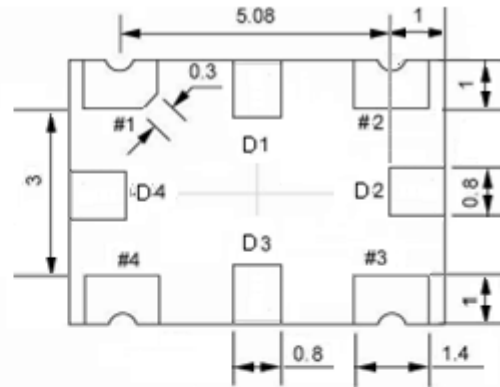

Bottom view

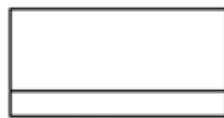

Right view



Side view

PIN FUNCTION

PIN	FUNCTION
D1,D2,D3,D4	NC
1	VC
2	GND
3	OUTPUT
4	VCC

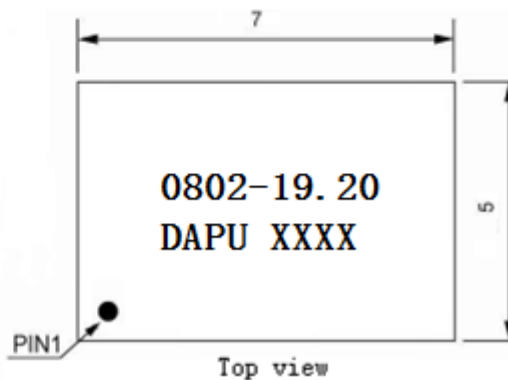

Top view

Note1: Tolerance $\pm 0.2\text{mm}$ without mark

Note2: The first two xx representative: week

After two xx representative: year

Note3: Referential Weight 0.2g

Note4: NC is not connect



3. Test Circuit

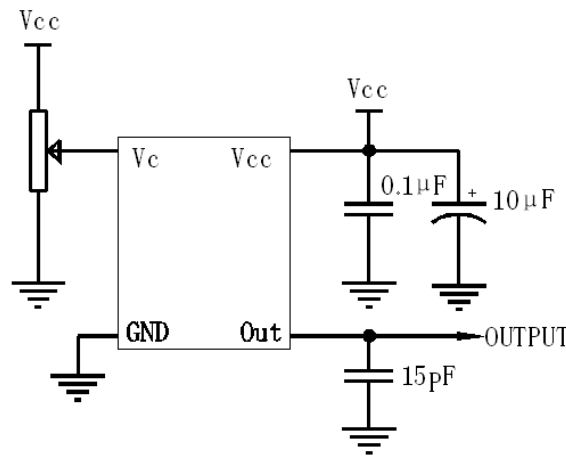

4. Output Waveform

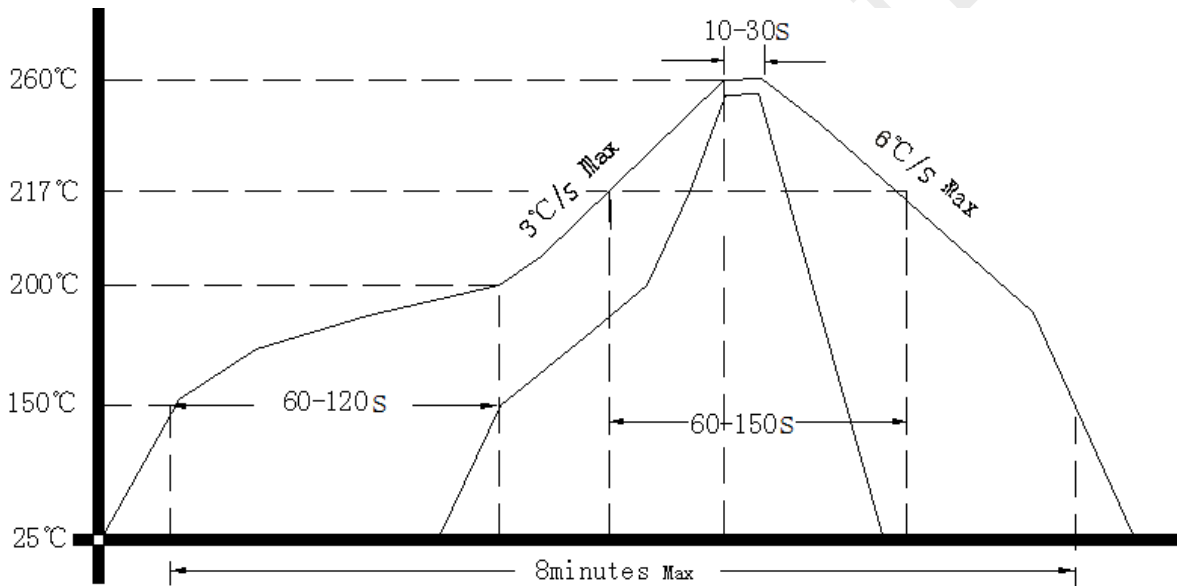

5. Package: Tape & Reel (mm)

