



DP2647S

ENG PART: DP-15.5IM-758T803-CW

758MHz to 803MHz Single-Junction Surface Mount Isolator

REV.	DESCRIPTION	REVISOR	DATE	APPROVED
A	SAME AS REV.1	ZZ.Zhu	2023/7/24	Nick

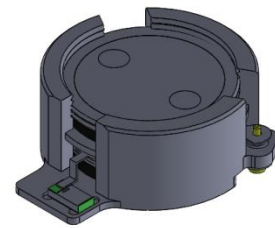

Applications:

- Wireless Infrastructure
- Power Amplifier

Features:

- Operating frequency range: 758MHz to 803MHz
- Operating temperature range: -40°C to +105°C
- Storage temperature range: -50°C to +110°C
- Small surface-mount package delivered on T&R
- BeOfree&RoHS compliant

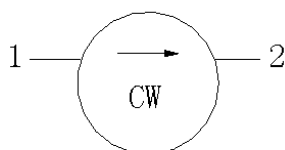

Block Diagram



Electrical Specifications:

ITEM	SPECIFICATION	
Frequency	758~803	MHz
Direction	CW	
Impedance	Typ: 50	Ω
Insertion Loss (Max.)	0.30@25 \pm 5 $^{\circ}$ C 0.35@-40~+105 $^{\circ}$ C	dB
Isolation (Min.)	21@25 \pm 5 $^{\circ}$ C 18@-40~+85 $^{\circ}$ C	dB
Return Loss (Min.)	21@25 \pm 5 $^{\circ}$ C 18@-40~+105 $^{\circ}$ C	dB
3rd IMD (Max.)	-60@2x1W CW tones, 1MHz spacing	dBc
Extend frequency	/	MHz
Group delay	3	ns
2nd harmonic	-10	dB
3rd harmonic	-5	dB
Power FWD/REV/PEAK	50/10/300	W
Termination/Attenuator	20/-	W/dB

Notes:

1. Exposure to maximum rating conditions for extended periods may reduce device reliability. There is no damage to device with only one parameter set at the limit and all other parameters set at or below their nominal value. Exceeding any of the limits listed here may result in permanent damage to the device.
2. Performance is guaranteed under the conditions listed in this table and over the operating temperature range.



Mechanical Specifications:

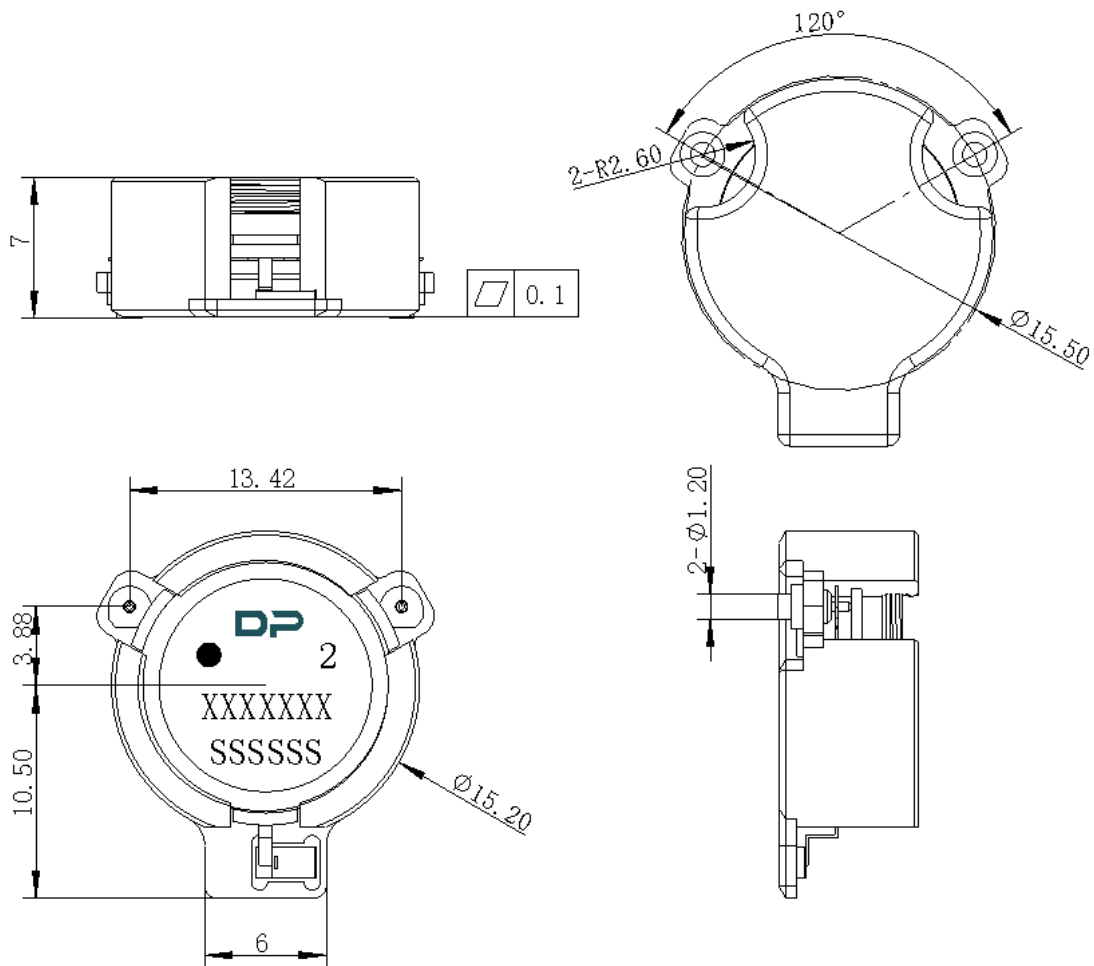

Unit: Millimeters

Notes:

1. The housing and pins are silver-plated.
2. Tolerance ± 0.2 mm unless otherwise specified.
3. Co-planarity Specification: 0.1mm maximum.
4. Part Number, Lot Code, and Port Designation are printed on the top side of device.
5. The **XXXXXXX** on the label represents the part number
6. The **SSSSSS** on the label represents the serial number
7. The black dot on the label represents the input port