

5mm SMD CIRCULATOR

RF component

Datasheet No.: DP-B-0048(00)
Date: 2021.04.14

Customer:

Product Name:

DP-CL0520A3450
DP-CL0520B3450

Customer P/N:



GuangdongDapuTelecomTechnologyCo.,Ltd Bldg13-16,.N.Ind.Zone,SSLIndustry
http://www.dptel.com Park,DongguanCity,Guangdong
Province,PRChina
TEL:0086-0769-88010888
FAX:0086-0769-81800098

Approved	Checked	Designer
Patrick	Nina	Emma

5mm SMD CIRCULATOR

RF component

 Datasheet No.: DP-B-0048(00)

 Date: 2021.04.14

MECHANICAL SPECIFICATION

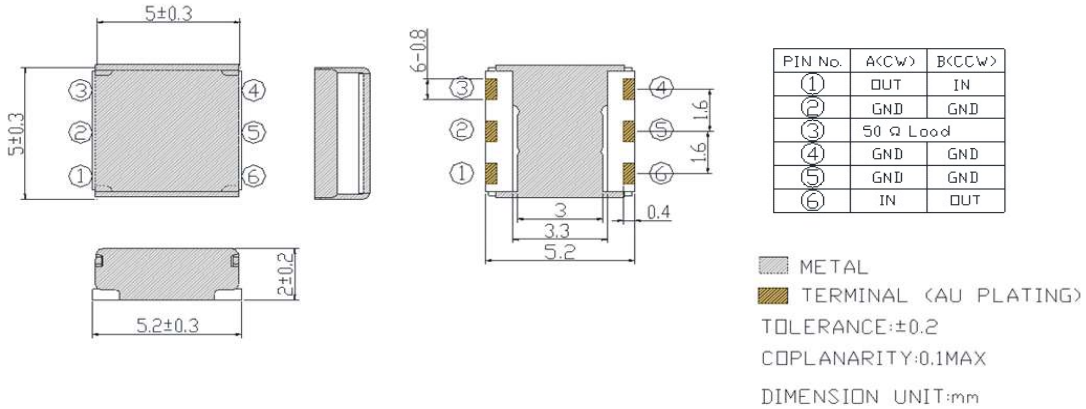

MARKING

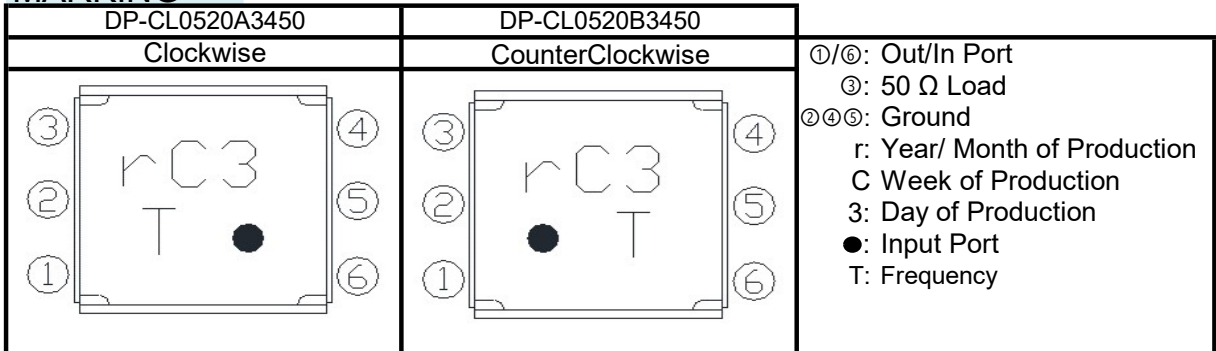

Year/Month Code											
Year	Month	Code	Year	Month	Code	Year	Month	Code	Year	Month	Code
2020 2024 2028	1	a	2021 2025 2029	1	n	2022 2026 2030	1	A	2023 2027	1	N
	2	b		2	p		2	B		2	P
	3	c		3	q		3	C		3	Q
	4	d		4	r		4	D		4	R
	5	e		5	s		5	E		5	S
	6	f		6	t		6	F		6	T
	7	g		7	u		7	G		7	U
	8	h		8	v		8	H		8	V
	9	j		9	w		9	J		9	W
	10	k		10	x		10	K		10	X
	11	l		11	y		11	L		11	Y
	12	m		12	z		12	M		12	Z

Week Code	
Week	Code
1	A
2	B
3	C
4	D
5	E

Day Code	
Day	Code
Monday	1
Tuesday	2
Wednesday	3
Thursday	4
Friday	5
Saturday	6
Sunday	7

5mm SMD CIRCULATOR

RF component

Datasheet No.: DP-B-0048(00)

Date: 2021.04.14

TEMPERATURE RANGE

Operating temperature range : -40~+85°C

Storage temperature range:-40~+125°C

ELECTRICAL CHARACTERISTICS

Parameter	Unit	Frequency (MHz)			Customer Spec			DP Spec		
					Min.	Typ.	Max.	Min.	Typ.	Max.
Frequency range	MHz	3300		3600	3300		3600	3300		3600
Insertion Loss(P1-P2)	dB									0.90
Isolation (P1-P2)	dB							10		
Return Loss(P1,P2)	dB							12		
Power Handling (Average)	W									5

NOTES

- 1.Recommend to keep 30mm above when mounted with other magnetic products.
- 2.ROHS compliance.
- 3.Isolator's characteristics are guaranteed at conditions listed at above table and it's operating temperature range.

5mm SMD CIRCULATOR

RF component

Datasheet No.: DP-B-0048(00)
 Date: 2021.04.14

RECOMMENDED LAND PATTERN

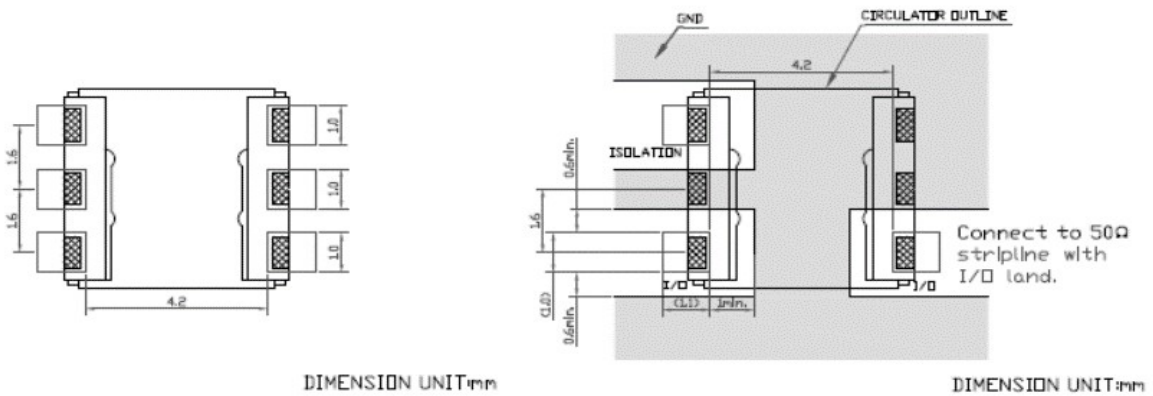

RECOMMENDED REFLOW PROFILE

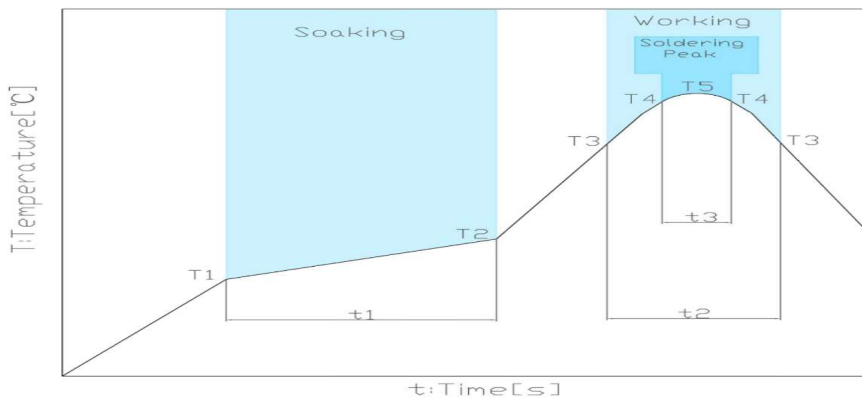

Soaking			Working		Soldering Peak		
Temp.	Temp.	Time	Temp.	Time	Temp.	Time	Temp.
T1	T2	t1	T3	t2	T4	t3	T5
150°C	180°C	60 to 120s	230°C	30 to 60s	250°C	within 10s	260°C max.

5mm SMD CIRCULATOR

RF component

Datasheet No.: DP-B-0048(00)
 Date: 2021.04.14

PACKING STYLE

REEL DIMENSIONS

Reel side \longrightarrow Pulling side

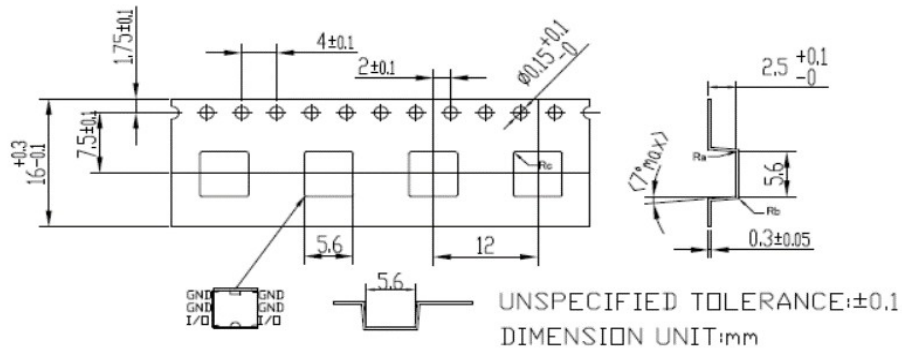

TAPE DIMENSIONS

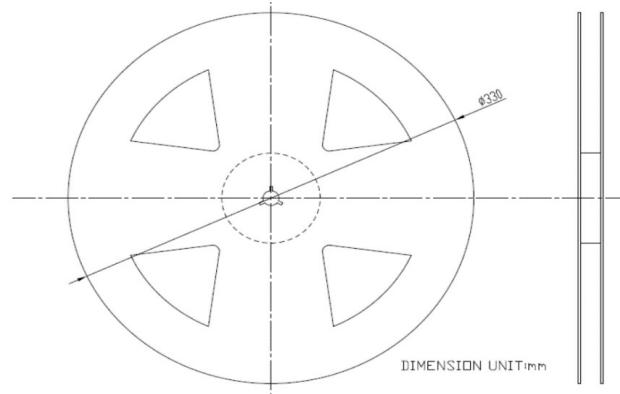

PACKAGE QUANTITY

1000 PCS/REEL

5mm SMD CIRCULATOR

RF component

Datasheet No.: DP-B-0048(00)
 Date: 2021.04.14

Revision Records

Rev.	Date	PIC	Change item	Reasons for change
1	2021.04.14	Nina	New regulations	
2				
3				
4				
5				
6				
7				
8				