

Customer Code : _____

DATASHEET

DAPU P/N : **T32-B573-19.20MHz**

Customer P/N: _____

DAPU			Customer Approval
Drew	Audited	Approved	Stamp, please! Thanks!
Date: 2022.10.10			

Guangdong Dapu Telecom Technology Co.,Ltd

Building 5, No.24, Industrial East Road, Songshanhu Park, Dongguan, Guangdong, P.R. China

TEL: 0086-0769-88010888 FAX: 0086-0769-81800098



1. Electrical Parameters

MODEL: T32-B573-19.20MHz						
Item	Description	Parameters			Unit	Test Condition
		Min.	Typ.	Max.		
Output	Frequency	19.20			MHz	
	Output Waveform	Clipped Sine Wave				
	Vp-p	0.8			V	
	Start up Time			3	ms	Stabilization time to +/-0.5ppm of final frequency.
	Load	10KΩ//10pF				
Frequency Stabilities	Overall Stability	-4.6		+4.6	$\times 10^{-6}$	Including frequency stability vs.temperature tolerance ex factory, aging over 20 years, supply&load variation.
	Frequency Tolerance vs. Operating Temperature Range	-0.28		+0.28	$\times 10^{-6}$	T _A varied from -40 to 85°C, measurement referenced to frequency observed with f _{ref} =(f _{max} +f _{min})/2, V _{cc} =1.8V, V _c =0.9V O _{load} =10KΩ//10pF, temperature variable speed less than 2°C per minute.
	Initial Frequency Tolerance	-1		+1	$\times 10^{-6}$	Measurement referenced to frequency observed with T _A =25°C, V _{cc} =1.8V, V _c =0.9V within 30 days after ex-works.
		-0.5		+0.5	$\times 10^{-6}$	Measurement referenced to frequency before reflow, tested with T _A =25°C, V _{cc} =1.8V, V _c =0.9V, O _{load} =10KΩ//10pF. At least 4 hours of static placement at room temperature is necessary after completion of 2 times reflow.
	Frequency Tolerance vs. Supply Voltage	-0.1		+0.1	$\times 10^{-6}$	measurement referenced to frequency observed T _A =25°C, V _{cc} varied from 1.71V to 1.89V, V _c =0.9V and O _{Load} =10KΩ//10pF.
	Frequency Tolerance vs. Load	-0.1		+0.1	$\times 10^{-6}$	5% load change measurement referenced to frequency observed with T _A =25°C, V _{cc} =1.8V, V _c =0.9V, O _{Load} =10KΩ//10pF.
	Holdover	-0.37		+0.37	$\times 10^{-6}$	Including frequency stability over temp. and short term aging in 24h.
	Short Term		0.1	0.2	$\times 10^{-9}$	Allan Deviation (ADEV), tau=1 second, at constant temperature.



	Aging Tolerance Per Day	-0.02		+0.02	$\times 10^{-6}$	$T_A=25^\circ\text{C}$, $V_{cc}=1.8\text{V}$, $V_c=0.9\text{V}$ and after 1h of operation.
	Aging Tolerance First Year	-1		+1	$\times 10^{-6}$	
	Aging Tolerance 20 Years	-3		+3	$\times 10^{-6}$	
Power Supply	Current Consumption			3	mA	@ 25°C , $V_{cc}=1.8\text{V}$, $V_c=0.9\text{V}$ $O_{load}=10\text{K}\Omega//10\text{pF}$.
	Supply Voltage	1.71	1.8	1.89	V	
Phase Noise	Phase Noise		-90	-85	dBc/Hz	10Hz
			-120	-115		100Hz
			-140	-135		1KHz
			-145	-140		10KHz
			-148	-143		100KHz
Voltage Control Characteristics	Frequency Tuning Range	-15		-10	$\times 10^{-6}$	$V_c=0\text{V}$. measurement referenced to $V_c=0.9\text{V}$
		-1		+1	$\times 10^{-6}$	$V_c=0.9\text{V}$. measurement referenced to exactly 19.20MHz
		+10		+15	$\times 10^{-6}$	$V_c=1.8\text{V}$. measurement referenced to $V_c=0.9\text{V}$
	Linearity			10	%	
	Slope	Positive				
	Input Impedance	100			K Ω	
Environmental Conditions	Operable Temperature	-40		+85	$^\circ\text{C}$	
	Storage Temperature	-55		+105	$^\circ\text{C}$	
	ESD Level	Human Body Model, class2: 2000V to 4000V; ANSI/ESDA/JEDEC JS-001-2010.				
		Machine Model, class B: 200V to 400V; JEDEC JESD22-A115C.				
	Moisture Sensitivity Level	Level 1.				
	Vibration	Test Condition: 0.75mm ;acceleration:10g;10Hz~2000Hz, one cycle per 30 min, test 2 hour. (3 times for each 3 directions X ,Y , Z) .IEC 68-2-06 Test Fc.				
Shock	100g; 6ms; half sine wave (3 times for each 3 directions X ,Y , Z) ,IEC 68-2-27 Test Ea/Severity 50A.					
Full Package Storage	Relative humidity (%)	20% ~ 70%				
	Temperature ($^\circ\text{C}$)	-10~35 $^\circ\text{C}$				



2. Mechanical Structure(mm)

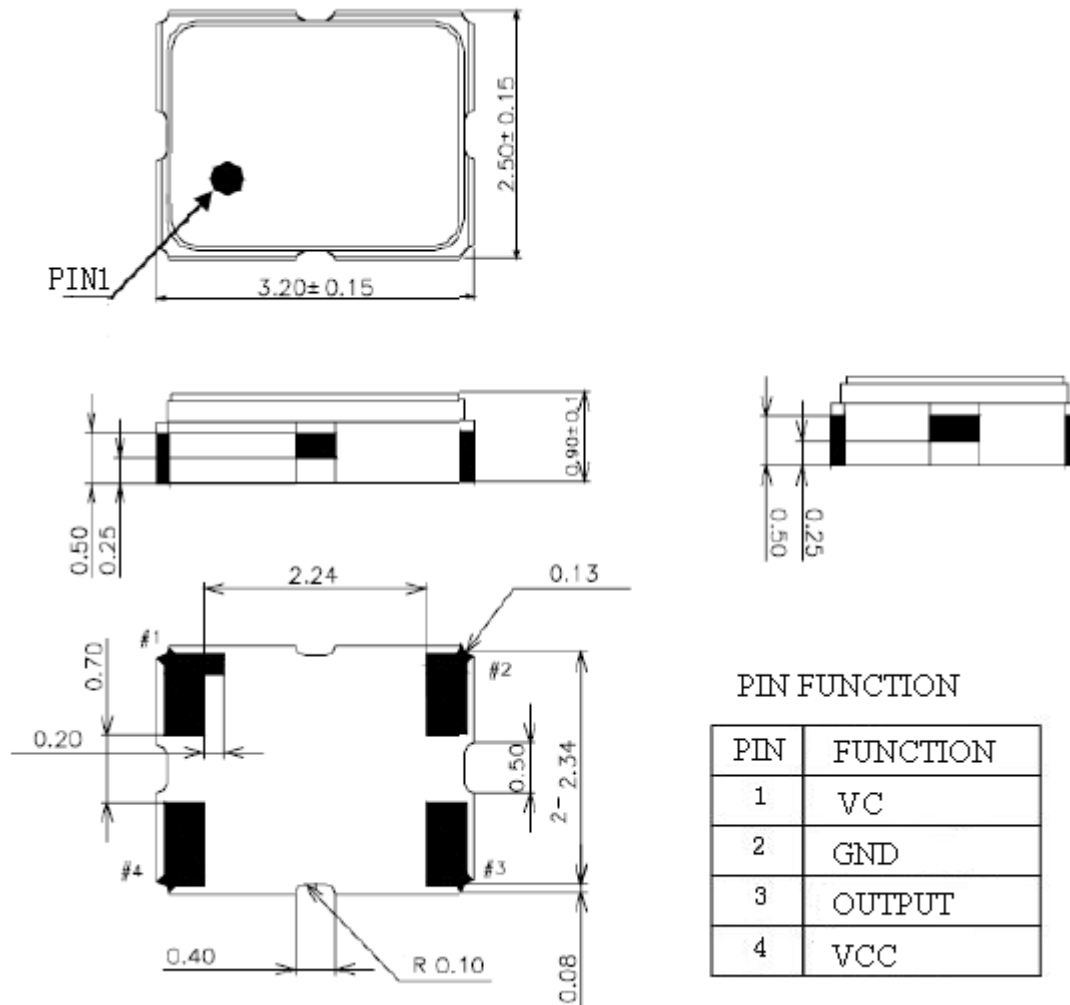

Note1: Tolerance $\pm 0.1\text{mm}$ without mark

Note2: Referential weight 0.02g

3. Test circuit

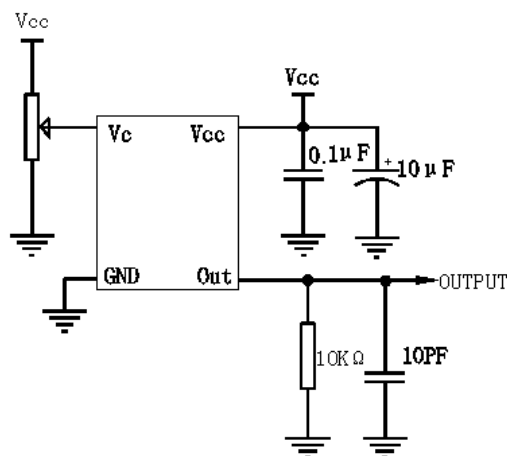



4. Reflow Soldering Curve (RoHS)

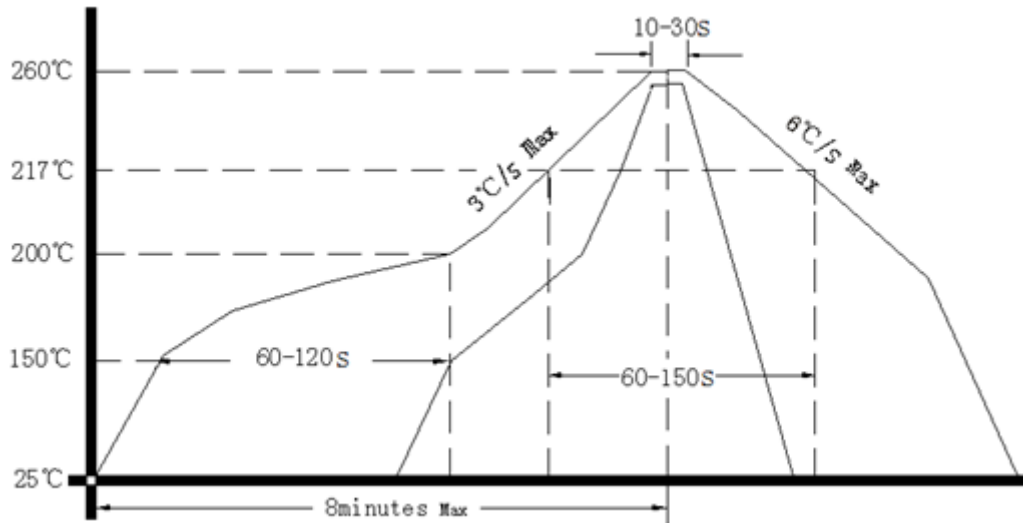

Note: If soldering with a hot air gun, ensure the temperature < 320°C , soldering time < 15 seconds.

5. Package: Tape & Reel (mm)

