

Travelling Merchant: \_\_\_\_\_

# DATASHEET

Standard: T75B-M317-38.88MHz-I

P/N: \_\_\_\_\_

Plot			The Label
Drew	Audited	Approved	Stamp, please! Thanks!
Date: 2023.01.03			

## Guangdong Dapu Telecom Technology Co.,Ltd

Building 5, No.24, Industrial East Road, Songshanhu Park, Dongguan, Guangdong, P.R. China

TEL: 0086-0769-88010888 FAX: 0086-0769-81800098





## 1. Electrical Parameters

MODEL: T75B-M317-38.88MHZ-I						
Item	Description	Parameters			Unit	Test Condition
		Min.	Typ.	Max.		
Output	Frequency	38.88			MHz	
	Output Waveform	HCMOS				
	Output Low Voltage			0.4	V	$V_{CC}=3.3V, O_{load}=15\text{ pF}$
	Output High Voltage	2.4			V	$V_{CC}=3.3V, O_{load}=15\text{ pF}$
	Duty Cycle	45	50	55	%	@50%
	Rise / Fall Time (10%~90%)			8	ns	@25°C
	Start up Time			3	ms	Stabilization time to +/-0.5ppm of final frequency.
	Load	15			pF	
Frequency Stabilities	Overall Stability	-4.6		+4.6	$\times 10^{-6}$	Including frequency stability vs.temperature tolerance ex factory, aging over 20 years, supply&load variation.
	Frequency Tolerance vs. Operating Temperature Range	-0.05		+0.05	$\times 10^{-6}$	$T_A$ varied from -40°C to 105°C, measurement referenced to frequency observed with $f_{ref}=(f_{max}+f_{min})/2, V_{CC}=3.3V, V_C=1.65V, O_{load}=15\text{ pF}$ .
	Initial Frequency Tolerance	-1		+1	$\times 10^{-6}$	Measurement referenced to frequency observed with $T_A=25^\circ\text{C}, V_{CC}=3.3V, V_C=1.65V$ within 30 days after ex-works.
		-0.5		+0.5	$\times 10^{-6}$	Measurement referenced to frequency before reflow, tested with $T_A=25^\circ\text{C}$ and $V_{CC}=3.3V, V_C=1.65V, O_{load}=15\text{ pF}$ . At least 4 hours of static placement at room temperature is necessary after completion of 2 times reflow.
	Frequency Tolerance vs. Supply Voltage	-0.1		+0.1	$\times 10^{-6}$	measurement referenced to frequency observed $T_A=25^\circ\text{C}, V_{CC}$ varied from 3.13V to 3.47V, $V_C=1.65V$ and $O_{Load}=15\text{ pF}$ .
	Frequency Tolerance vs. Load	-0.1		+0.1	$\times 10^{-6}$	5% load change measurement referenced to frequency observed with $T_A=25^\circ\text{C}, V_{CC}=3.3V, V_C=1.65V, O_{Load}=15\text{ pF}$
	Holdover	-0.37		+0.37	$\times 10^{-6}$	Including frequency stability over temp. and short term aging in 24h.
	Short Term		0.1	0.2	$\times 10^{-9}$	Allan Deviation (ADEV), tau=1 second, at constant temperature.



	Aging Tolerance Per Day	-0.01		+0.01	$\times 10^{-6}$	$T_A=25^{\circ}\text{C}$ , $V_{cc}=3.3\text{V}$ , $V_c=1.65\text{V}$ and after 1h of operation.
	Aging Tolerance First Year	-1		+1	$\times 10^{-6}$	
	Aging Tolerance 20 Years	-3		+3	$\times 10^{-6}$	
Power Supply	Current Consumption			10	mA	@ $25^{\circ}\text{C}$ , $V_{cc}=3.3\text{V}$ , $V_c=1.65\text{V}$ , $O_{load}=15\text{pF}$ .
	Supply Voltage	3.13	3.3	3.47	V	
Voltage Control Characteristics	Frequency Tuning Range			-8	$\times 10^{-6}$	$V_c=0\text{V}$ . measurement referenced to $V_c=1.65\text{V}$
		-1		+1	$\times 10^{-6}$	$V_c=1.65\text{V}$ . measurement referenced to exactly 38.88MHz
		+8			$\times 10^{-6}$	$V_c=3.3\text{V}$ . measurement referenced to $V_c=1.65\text{V}$
	Linearity			10	%	
	Slope	Positive				
	Input Impedance	100			K $\Omega$	
Phase Noise	Phase Noise @ $25^{\circ}\text{C}$		-90	-85	dBc/Hz	10Hz
			-115	-110		100Hz
			-135	-130		1KHz
			-148	-143		10KHz
			-150	-145		100KHz
			-151	-146		1MHz
Environmental Conditions	Operable Temperature	-40		+105	$^{\circ}\text{C}$	
	Storage Temperature	-55		+105	$^{\circ}\text{C}$	
	ESD Level	Human Body Model,class2: 2000V to 4000V; ANSI/ESDA/JEDEC JS-001-2010.				
		Machine Model, class B: 200V to 400V; JEDEC JESD22-A115C.				
	Moisture Sensitivity Level	Level 2.				
	Vibration	Test Condition: 0.75mm ;acceleration:10g;10Hz~2000Hz, one cycle per 30 min, test 2 hour. (3 times for each 3 directions X ,Y , Z) .IEC 68-2-06 Test Fc.				
Shock	100g; 6ms; half sine wave (3 times for each 3 directions X ,Y , Z ),IEC 68-2-27 Test Ea/Severity 50A.					
Full Package Storage	Relative humidity (%)	20%~70%				
	Temperature ( $^{\circ}\text{C}$ )	-10~35 $^{\circ}\text{C}$				



## 2. Mechanical Structure(mm)

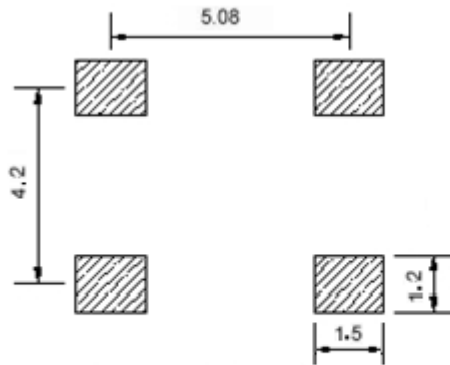

Solder pad layout

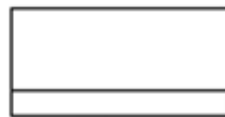

Right view

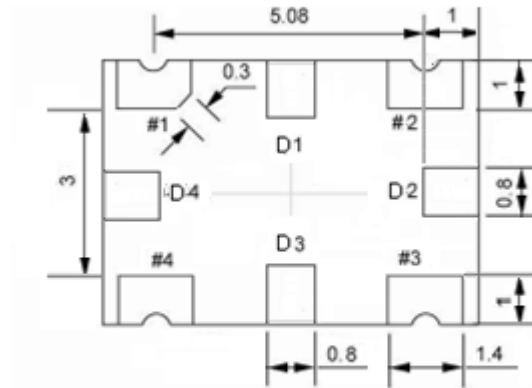

Bottom view

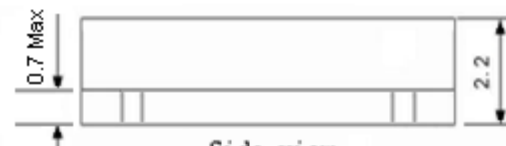

Side view

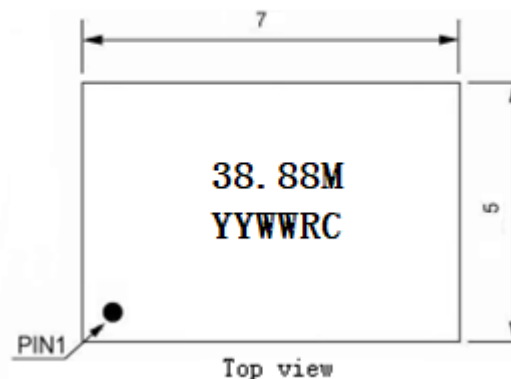

Top view

### PIN FUNCTION

PIN	NOTATION	FUNCTION
D1, D2, D3, D4	NC	Not Connect
1	VC	Control Voltage
2	GND	GND
3	OUTPUT	RF Output
4	VCC	Supply Voltage

**Note1:** Tolerance  $\pm 0.2\text{mm}$  without mark

**Note2:** Referential Weight 0.2g

**Note3:** Marking:

Line 1 = Frequency

Line 2 = Data code: the YY representative: year, After WW representative: week, Factory code: RC

Pin 1 denominator to be included where applicable and possible

**Note4:** NC is not connect



### 3. Test circuit

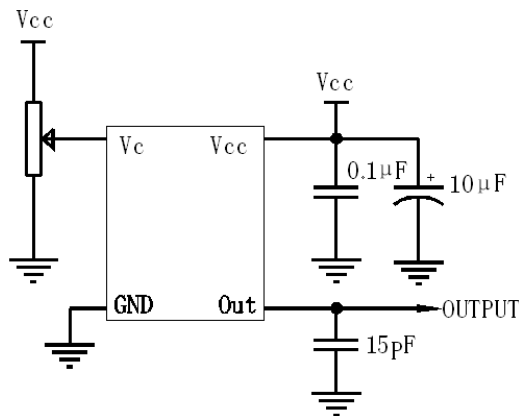

### 4. Reflow Soldering Curve (RoHS)

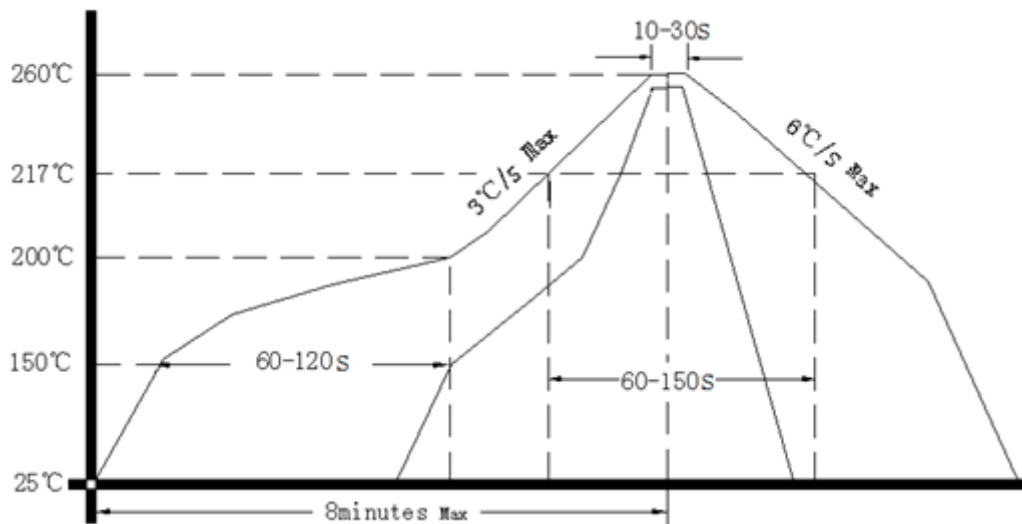

**Note:** If soldering with a hot air gun, ensure the temperature < 320°C , soldering time < 15 seconds.

### 5. Package: Tape & Reel (mm)

