

Customer Code : _____

DATASHEET

DAPU P/N: **T53-F586-38.40MHz-A**

Customer P/N: _____

DAPU			Customer Approval
Drew	Audited	Approved	Stamp, please! Thanks!
Date: 2020.11.25			

Guangdong Dapu Telecom Technology Co.,Ltd

Bldg 16,.N.Ind.Zone,SSL Industry Park, Dongguan City, Guangdong Province, China

TEL: 0086-0769-88010888 FAX: 0086-0769-81800098



1. Electrical Parameters

MODEL: T53-F586-38.40MHz-A						
Item	Description	Parameters			Unit	Test Condition
		Min.	Typ.	Max.		
Output	Frequency	38.40			MHz	
	Output Waveform	Clipped Sine Wave				
	Vp-p	0.8			V	
	Start-up Time			2	ms	Time taken for output to reach 90% of specified output level.
	Load	10KΩ//10pF				
Frequency Stabilities	Frequency Tolerance vs. Operating Temperature Range	-0.25		+0.25	$\times 10^{-6}$	T_A varied from -40°C to 105°C , measurement referenced to frequency observed with $f_{\text{ref}}=(f_{\text{max}}+f_{\text{min}})/2$, $V_{\text{cc}}=2.85\text{V}$, $V_c=1.5\text{V}$, $O_{\text{load}}=10\text{K}\Omega//10\text{pF}$, temperature variable speed less than 1°C per minute.
	Initial Frequency Tolerance	-1		+1	$\times 10^{-6}$	Measurement referenced to frequency observed with $T_A=25^{\circ}\text{C}$, $V_{\text{cc}}=2.85\text{V}$, $V_c=1.5\text{V}$ within 30 days after ex-works.
	Reflow Shift	-1		+1	$\times 10^{-6}$	Two consecutive reflows as per attached profile after 2hours relaxation at 25°C .
	Frequency slope	-0.1		+0.1	$\times 10^{-6}/^{\circ}\text{C}$	Minimum of one frequency reading every 2°C over the operating temperature range.
	Frequency Tolerance vs. Supply Voltage	-0.1		+0.1	$\times 10^{-6}$	measurement referenced to frequency observed $T_A=25^{\circ}\text{C}$, V_{cc} varied from 2.7V to 3.0V, $V_c=1.5\text{V}$ and $O_{\text{Load}}=10\text{K}\Omega//10\text{pF}$.
	Frequency Tolerance vs. Load	-0.2		+0.2	$\times 10^{-6}$	10% load change measurement referenced to frequency observed with $T_A=25^{\circ}\text{C}$, $V_{\text{cc}}=2.85\text{V}$, $V_c=1.5\text{V}$ and $O_{\text{Load}}=10\text{K}\Omega//10\text{pF}$.
	Aging Tolerance Per Day	-0.02		+0.02	$\times 10^{-6}$	$T_A=25^{\circ}\text{C}$, $V_{\text{cc}}=2.85\text{V}$, $V_c=1.5\text{V}$ and after 1h of operation.
	Aging Tolerance 1 Month	-0.2		+0.2	$\times 10^{-6}$	
	Aging Tolerance 1 Year	-1		+1	$\times 10^{-6}$	
Aging Tolerance 3 Year	-2		+2	$\times 10^{-6}$		
Power Supply	Operating Current			3.7	mA	@ 25°C , $V_{\text{cc}}=2.85\text{V}$, $V_c=1.5\text{V}$, $O_{\text{Load}}=10\text{K}\Omega//10\text{pF}$.
	Supply Voltage	2.7	2.85	3.0	V	



Voltage Control	Frequency tuning range	-10		-5	$\times 10^{-6}$	$V_c=0.5V$. measurement referenced to $V_c=1.5V$.
		-1		+1	$\times 10^{-6}$	$V_c=1.5V$. measurement referenced to Exactly 38.40MHz.
		+5		+10	$\times 10^{-6}$	$V_c=2.5V$. measurement referenced to $V_c=1.5V$.
	Linearity			10	%	
	Slope	Positive				
Input Impedance	100				K Ω	
Phase Noise	Phase Noise @25°C		-55		dBc/Hz	1Hz
			-84			10Hz
			-108			100Hz
			-130			1KHz
			-148			10KHz
			-153			100KHz
			-153			1MHz
RMS Phase Jitter		0.3		ps	12KHz to 5MHz	
Environmental Conditions	Operable Temperature	-40		+105	°C	
	Storage Temperature	-55		+125	°C	
	ESD Level	Human Body Model, class2: 2000V to 4000V; ANSI/ESDA/JEDEC JS-001-2010.				
		Machine Model, class B: 200V to 400V; JEDEC JESD22-A115C.				
	Moisture Sensitivity Level	Level 3.				
	Vibration	Test Condition: 0.75mm ;acceleration:10g;10Hz~2000Hz, one cycle per 30 min, test 2 hour. (3 times for each 3 directions X , Y , Z) .IEC 68-2-06 Test Fc.				
Shock	100g; 6ms; half sine wave (3 times for each 3 directions X , Y , Z),IEC 68-2-27 Test Ea/Severity 50A.					
Full Package Storage	Relative humidity (%)	20%~70%				
	Temperature (°C)	-10~35°C				



2. Mechanical Structure(mm)

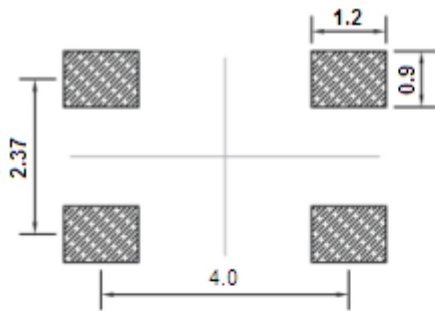

Solder pad layout

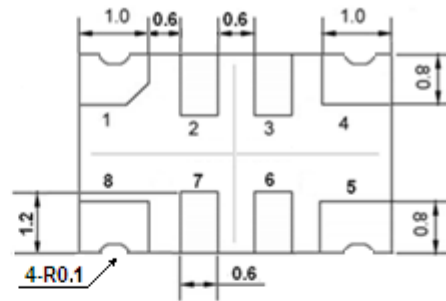

Bottom view

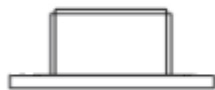

Right view

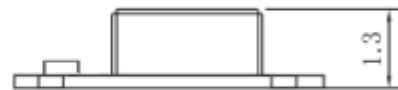

Side view

PIN FUNCTION

PIN	NOTATION	FUNCTION
1	VC	Control Voltage
2, 3	NC	Not Connect
4	GND	GND
5	OUTPUT	RF Output
6, 7	NC	Not Connect
8	VCC	Supply Voltage

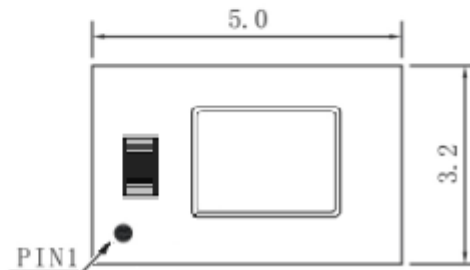

Top view

Note1: Tolerance $\pm 0.2\text{mm}$ without mark

Note2: Referential weight 0.05g



3. Test Circuit

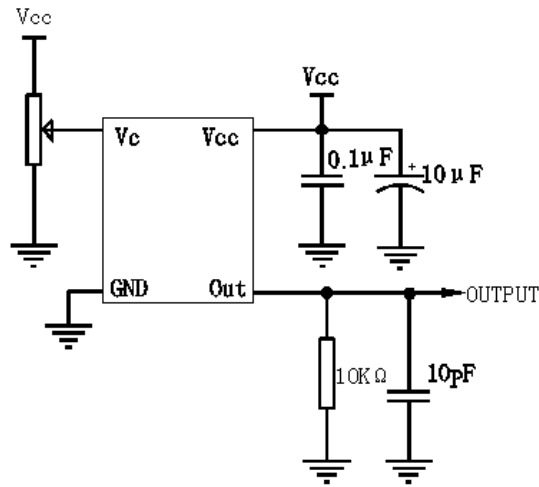

4. Reflow Soldering Curve (RoHS)

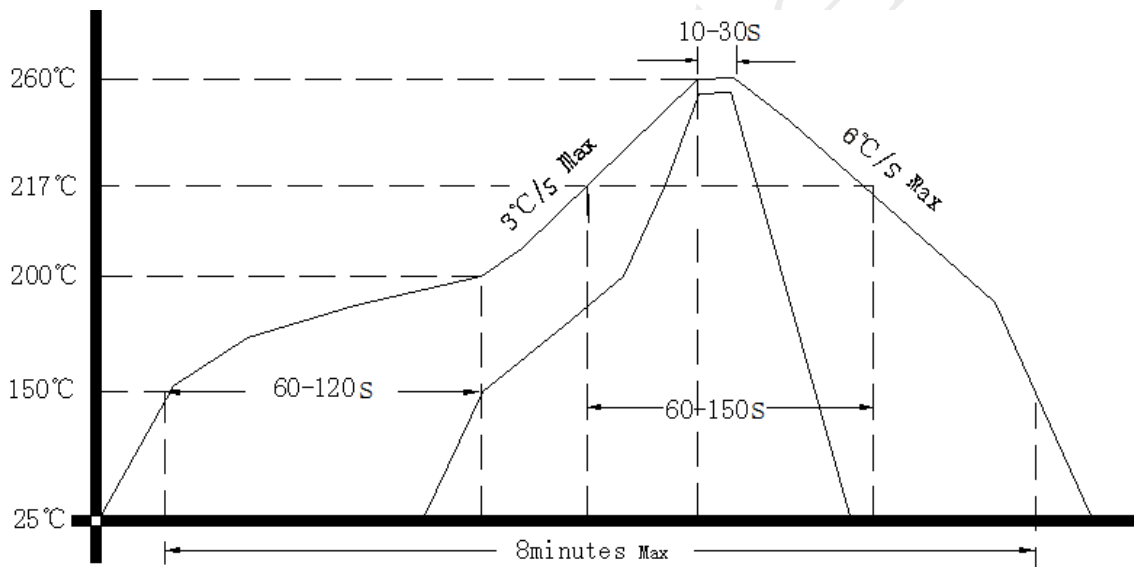

5. Package: Tape & Reel (mm)

