

Customer Code : \_\_\_\_\_

# DATASHEET

DAPU P/N:     **T53-Y513-40.00MHz**    

Customer P/N: \_\_\_\_\_

DAPU			Customer Approval
Drew	Audited	Approved	Stamp, please! Thanks!
Date: 2020.03.01			

## Guangdong Dapu Telecom Technology Co.,Ltd

Bldg16,,N.Ind.Zone,SSL Industry Park, Dongguan City, Guangdong Province, China

TEL: 0086-0769-88010888 FAX: 0086-0769-81800098





## 1. Electrical Parameters

MODEL: T53-Y513-40.00MHz						
Item	Description	Parameters			Unit	Test Condition
		Min.	Typ.	Max.		
Output	Frequency	40.00			MHz	
	Output Waveform	Clipped Sine Wave				
	Vp-p	0.6			V	
	Load	10KΩ//10pF				
Frequency Stabilities	Frequency Tolerance vs. Operating Temperature Range	-0.2		+0.2	$\times 10^{-6}$	$T_A$ varied from $-40^{\circ}\text{C}$ to $85^{\circ}\text{C}$ , measurement referenced to frequency observed with $f_{\text{ref}}=(f_{\text{max}}+f_{\text{min}})/2$ , $V_{\text{cc}}=3.3\text{V}$ , $V_c=1.5\text{V}$ , $O_{\text{load}}=10\text{K}\Omega//10\text{pF}$ , temperature variable speed less than $2^{\circ}\text{C}$ per minute.
	Initial Frequency Tolerance	-1		+1	$\times 10^{-6}$	Measurement referenced to frequency observed with $T_A=25^{\circ}\text{C}$ , $V_{\text{cc}}=3.3\text{V}$ , $V_c=1.5\text{V}$ within 30 days after ex-works.
	Frequency Tolerance vs. Supply Voltage	-0.2		+0.2	$\times 10^{-6}$	measurement referenced to frequency observed $T_A=25^{\circ}\text{C}$ , $V_{\text{cc}}$ varied from 3.13V to 3.47V, $V_c=1.5\text{V}$ and $O_{\text{Load}}=10\text{K}\Omega//10\text{pF}$ .
	Frequency Tolerance vs. Load	-0.2		+0.2	$\times 10^{-6}$	5% load change measurement referenced to frequency observed with $T_A=25^{\circ}\text{C}$ , $V_{\text{cc}}=3.3\text{V}$ , $V_c=1.5\text{V}$ and $O_{\text{Load}}=10\text{K}\Omega//10\text{pF}$ .
	Aging Tolerance Per Day	-0.02		+0.02	$\times 10^{-6}$	$T_A=25^{\circ}\text{C}$ , $V_{\text{cc}}=3.3\text{V}$ , $V_c=1.5\text{V}$ and after 1h of operation.
	Aging Tolerance 1 Year	-1		+1	$\times 10^{-6}$	
Power Supply	Operating Current			6	mA	@ $25^{\circ}\text{C}$ , $V_{\text{cc}}=3.3\text{V}$ , $V_c=1.5\text{V}$ , $O_{\text{Load}}=10\text{K}\Omega//10\text{pF}$ .
	Supply Voltage	3.13	3.3	3.47	V	



Voltage Control	Frequency tuning range	-15		-10	$\times 10^{-6}$	$V_c=0.5V$ . measurement referenced to $V_c=1.5V$ .
		-1		+1	$\times 10^{-6}$	$V_c=1.5V$ . measurement referenced to Exactly 40.00MHz.
		+10		+15	$\times 10^{-6}$	$V_c=2.5V$ . measurement referenced to $V_c=1.5V$ .
	Linearity			10	%	
	Slope	Positive				
	Input Impedance	100				K $\Omega$
Phase Noise	Phase Noise @25°C		-130	-125	dBc/Hz	1KHz
Environmental Conditions	Operable Temperature	-40		+85	°C	
	Storage Temperature	-55		+105	°C	
	ESD Level	Human Body Model,class2: 2000V to 4000V; ANSI/ESDA/JEDEC JS-001-2010.				
		Machine Model, class B: 200V to 400V; JEDEC JESD22-A115C.				
	Moisture Sensitivity Level	Level 3.				
	Vibration	Test Condition: 0.75mm ;acceleration:10g;10Hz~2000Hz, one cycle per 30 min, test 2 hour. (3 times for each 3 directions X , Y , Z) .IEC 68-2-06 Test Fc.				
Shock	100g; 6ms; half sine wave (3 times for each 3 directions X , Y , Z ),IEC 68-2-27 Test Ea/Severity 50A.					
Full Package Storage	Relative humidity (%)	20%~70%				
	Temperature (°C)	-10~35°C				



## 2. Mechanical Structure(mm)

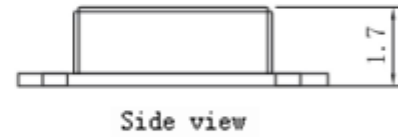
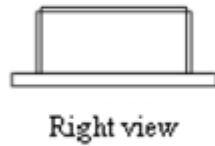
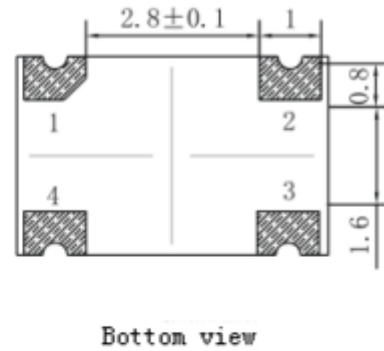
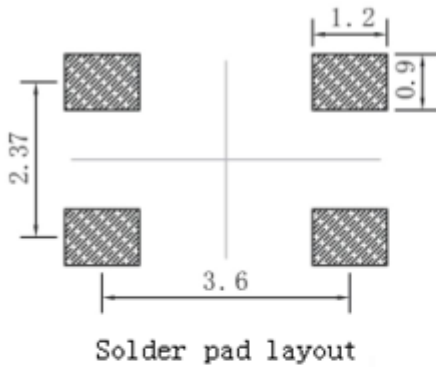

### PIN FUNCTION

PIN	NOTATION	FUNCTION
1	VC	Control Voltage
2	GND	GND
3	OUTPUT	RF Output
4	VCC	Supply Voltage

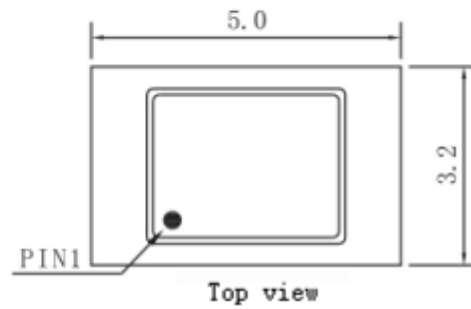

**Note1:** Tolerance  $\pm 0.2\text{mm}$  without mark

**Note2:** Referential Weight 0.05g



### 3. Test Circuit

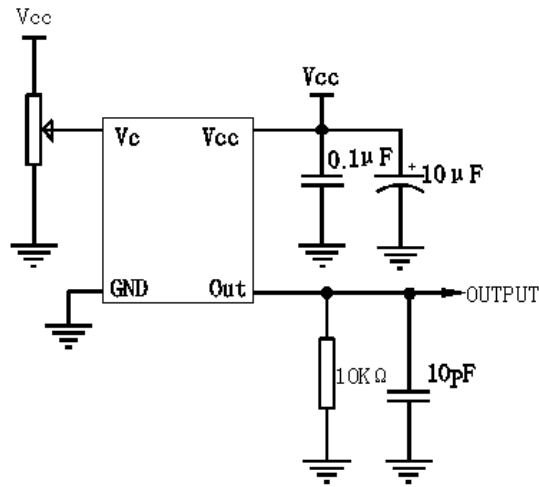

### 4. Reflow Soldering Curve (RoHS)

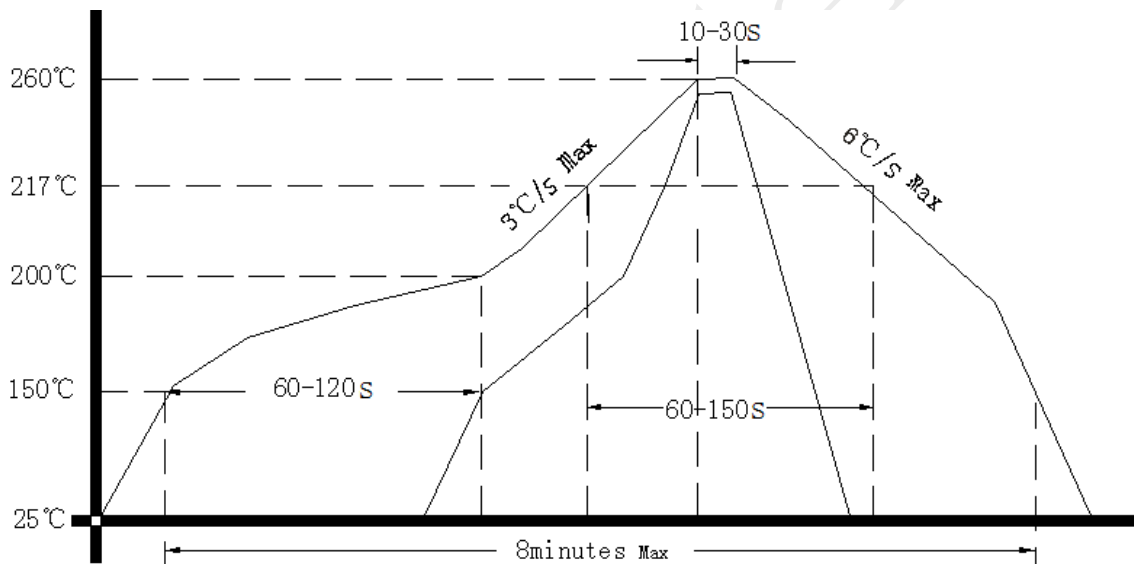

### 5. Package: Tape & Reel (mm)

