

Customer Code : \_\_\_\_\_

# DATASHEET

DAPU P/N: 022S-C313-10.00MHz

Customer P/N: \_\_\_\_\_

DAPU			Customer Approval
Drew	Audited	Approved	Stamp, please! Thanks!
Date: 2018.06.06			

## Guangdong Dapu Telecom Technology Co.,Ltd

Bldg13-16,.N.Ind.Zone,SSL Industry Park, Dongguan City, Guangdong Province, China

TEL: 0086-0769-88010888 FAX: 0086-0769-81800098



### Table of amendment

Version	Revision contents	Prepared by	Revised date
1.0	The first issued	<i>Amway</i>	2018.06.06



## 1. Electrical Parameters

MODEL: O22S-C313-10.00MHz						
Item	Description	Parameters			Unit	Test Condition
		Min.	Typ.	Max.		
Output	Frequency	10.00			MHz	
	Output Waveform	HCMOS				
	Output Low Voltage			0.4	V	$V_{cc}=3.3V, O_{load}=15pF$
	Output High Voltage	2.4			V	$V_{cc}=3.3V, O_{load}=15pF$
	Duty Cycle	45	50	55	%	@50%
	Rise / Fall Time (10%~90%)			10	ns	
	Load	15			pF	
Frequency Stabilities	Frequency Tolerance vs. Operating Temperature Range	-5		+5	$\times 10^{-9}$	$T_A$ varied from 0°C to 70°C, measurement referenced to frequency observed with $f_{ref}=(f_{max}+f_{min})/2, V_{cc}=3.3V, V_c=1.65V, O_{load}=15pF$ , temperature variable speed less than 2°C per minute.
	Initial Frequency Tolerance	-0.05		+0.05	$\times 10^{-6}$	Measurement referenced to frequency observed with $T_A=25^\circ C, V_{cc}=3.3V, V_c=1.65V$ , and after 15 minutes of operation, within 30 days after ex-works.
	Frequency Tolerance vs. Supply Voltage	-2		+2	$\times 10^{-9}$	measurement referenced to frequency observed $T_A=25^\circ C, V_{cc}$ varied from 3.13V to 3.47V, $V_c=1.65V$ , and $O_{Load}=15pF$ .
	Frequency Tolerance vs. Load	-2		+2	$\times 10^{-9}$	5% load change measurement referenced to frequency observed with $T_A=25^\circ C, V_{cc}=3.3V, V_c=1.65V$ , and $O_{Load}=15pF$ .
	Short-Term Stability: Allan Variance			0.01	$\times 10^{-9}$	Temperature stability, no EMI\EMC or other interference, test after power for 1hour ref. to 25°C; 1s, using PN9000 equipment.
	Aging Tolerance Per Day	-0.5		+0.5	$\times 10^{-9}$	$V_{cc}, V_c, T_A$ constant measurement referenced to frequency observed with $T_A=25^\circ C,$
	Aging Tolerance 1 Year	-0.05		+0.05	$\times 10^{-6}$	$V_{cc}=3.3V, V_c=1.65V$ , and after 30 days of operation.
Power Supply	Supply Voltage	3.13	3.3	3.47	V	
	Steady Consumption			400	mA	@25°C
	Warm up current			1000	mA	



Voltage Control Characteristics	Frequency Tuning Range	-0.8		-0.4	$\times 10^{-6}$	$V_c=0V$ . measurement referenced to $V_c=1.65V$
		-0.05		+0.05	$\times 10^{-6}$	$V_c=1.65V$ . measurement referenced to exactly 10.00MHz
		+0.4		+0.8	$\times 10^{-6}$	$V_c=3.3V$ . measurement referenced to $V_c=1.65V$
	Linearity			10	%	
	Slope	Positive				
	Input Impedance	100				K $\Omega$
Phase Noise	Phase Noise		-125	-115	dBc/Hz	10Hz
			-145	-135		100Hz
			-150	-145		1KHz
			-155	-150		10KHz
			-155	-150		100KHz
			-155	-150		1MHz
Environmental Conditions	Operable Temperature	0		+70	$^{\circ}C$	
	Storage Temperature	-55		+105	$^{\circ}C$	
	ESD Level	Human Body Model, class2: 2000V to 4000V; ANSI/ESDA/JEDEC JS-001-2010.				
		Machine Model, class B: 200V to 400V; ANSI/ESDA/JEDEC JS-001-2010.				
	Moisture Sensitivity Level	Level 3.				
	Vibration	Test Condition: 0.75mm ;acceleration:10g;10Hz~500Hz, one cycle per 30 min, test 2 hour. (3 times for each 3 directions X , Y , Z), IEC 68-2-06 Test Fc.				
Shock	50g; 11ms; half sine wave (3 times for each 3 directions X, Y, Z), IEC 68-2-27 Test Ea/Severity 50A.					
Full Package Storage	Relative humidity (%)	20%~70%				
	Temperature ( $^{\circ}C$ )	-10~35 $^{\circ}C$				



## 2. Mechanical Structure (mm)

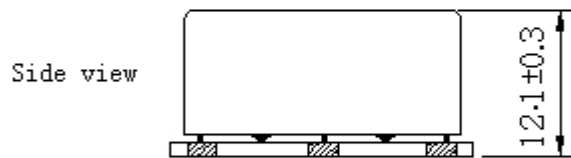
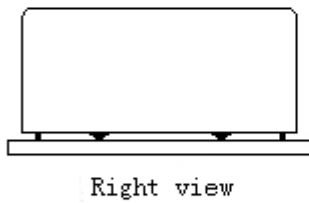
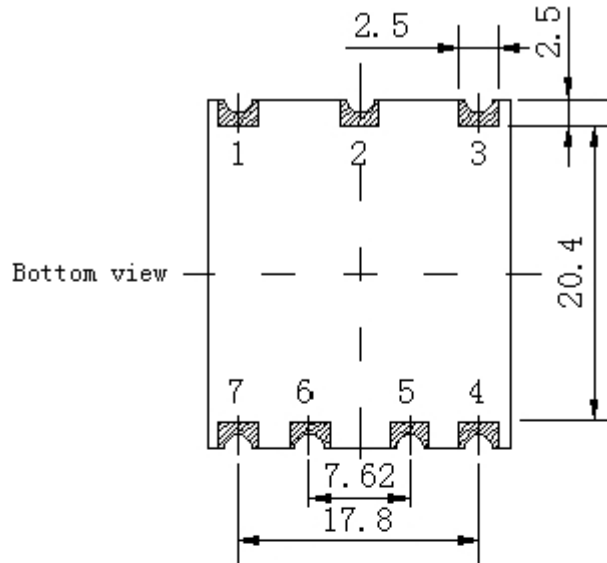
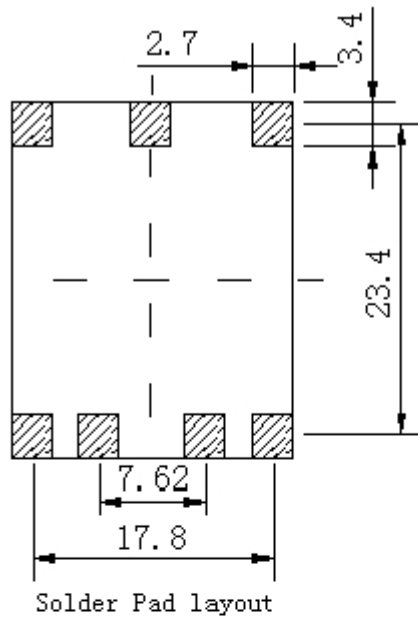

### PIN FUNCTION

PIN	NOTATION	FUNCTION
1	VC	Control Voltage
2	NC	Not Connect
3	VCC	Supply Voltage
4	OUTPUT	RF Output
5,6	NC	Not Connect
7	GND	GND

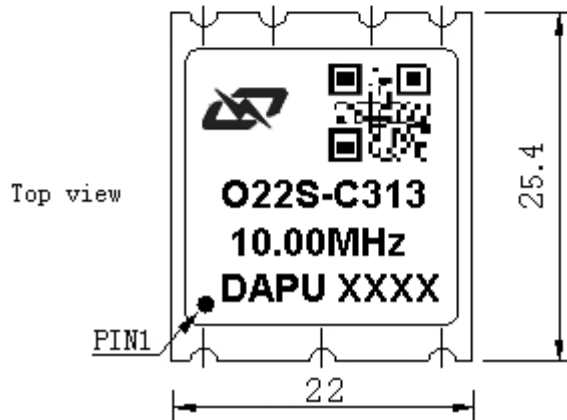

- Note1:** Tolerance  $\pm 0.2$ mm without mark
- Note2:** The first two xx representative: week  
After two xx representative: year
- Note3:** Referential weight 7.8g
- Note4:** NC is not connect



### 3. Test Circuit

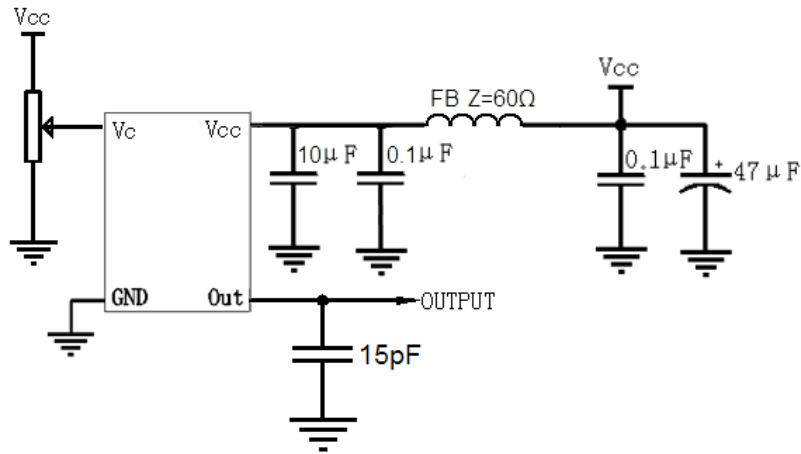

### 4. Reflow Soldering Curve (RoHS)

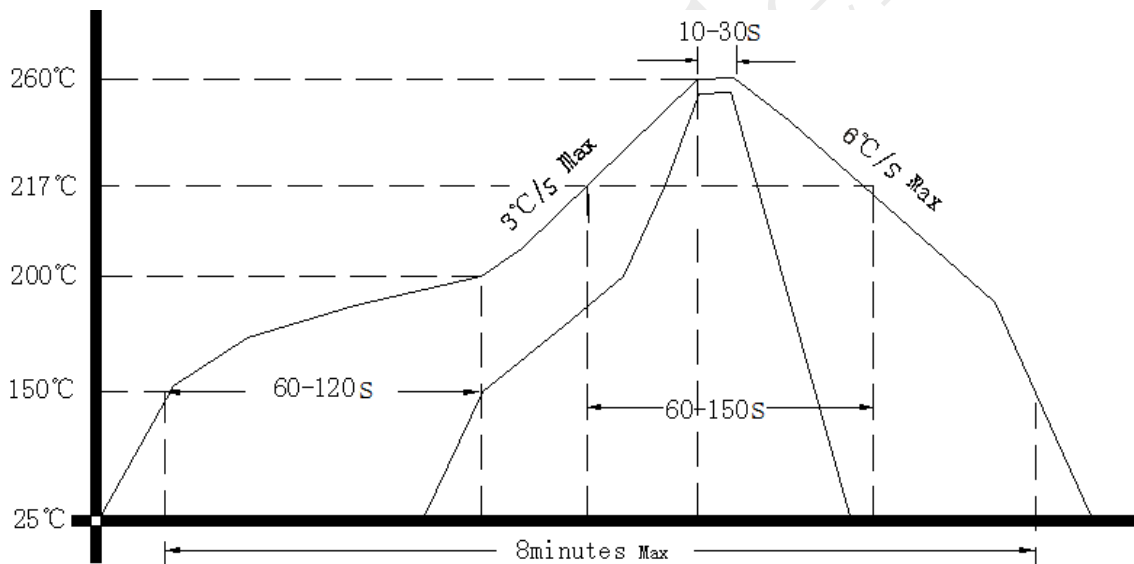

### 5. Package: Tape & Reel (mm)

